

Traffic Impact Analysis

Cypress Point Traffic Impact Analysis

Moss Beach, California

April 2019

Traffic Impact Analysis

Cypress Point Traffic Impact Analysis

Moss Beach, California

Prepared For:
MidPen Housing Corp.
303 Vintage Park Drive, Suite 250
Foster City, CA 94404
650.235.7675

Prepared By:
Kittelson & Associates, Inc.
155 Grand Avenue, Suite 900
Oakland, California 94612
(510) 839-1742

Project Manager: Aaron Elias, Senior Engineer, P.E.
Project Principal: Damian Stefanakis, Principal Planner

Project No. 20616

April 2019



TABLE OF CONTENTS

Executive Summary.....	vii
Project Trip Estimates	vii
Project Impacts	vii
Recommended Improvements.....	viii
Introduction	10
Project Description	10
Project Location and Study Area.....	13
Scope of Study	13
Existing Conditions	16
Roadway Network	16
Transit Service.....	17
Traffic Volumes.....	18
Intersection Operations.....	22
Transportation Impact Analysis.....	23
Thresholds of Significance	23
Project Analysis.....	24
Existing with Project Operations.....	28
Background Conditions	31
Cumulative Conditions.....	37
Design and Incompatible Use	44
Emergency Access	46
Transit Impacts... ..	46
Bicycle Impacts.....	46
Pedestrian Impacts.....	47
CEQA Project Impacts and Proposed Mitigations	49
State Route 92 Traffic Volumes.....	61
95 th Percentile Queue Analysis.....	62

LIST OF FIGURES

Figure 1: Project Location11

Figure 2: Site Plan12

Figure 3: Study Intersections15

Figure 4: Transit Service in Project Area19

Figure 5: Existing Traffic Control and Lane Configurations20

Figure 6: Existing Peak Hour Turning Movement Volumes and Operations21

Figure 7: Project Trips27

Figure 9: Existing with Project Turning Movement Volumes and Operations30

Figure 10: Background Conditions Turning Movement Volumes and Operations33

Figure 11: Background with Project Conditions Turning Movement Volumes and Operations36

Figure 12: Cumulative Conditions Lane Configurations and Traffic Control Devices39

Figure 13: Cumulative Conditions Turning Movement Volumes and Operations40

Figure 14: Cumulative with Project Turning Movement Volumes and Operations43

LIST OF TABLES

Table 1: Level of Service Definition for Intersections	22
Table 2: Existing Conditions Intersection Operations Results	23
Table 3: Project Trip Generation	25
Table 4: Project Trip Distribution along State Route 1	26
Table 5: Existing with Project AM Peak Hour Intersection Operations	28
Table 6: Existing with Project PM Peak Hour Intersection Operations	29
Table 7: Existing with Project Saturday Peak Hour Intersection Operations.....	29
Table 8: Background Conditions Intersection Operations Results	32
Table 9: Background with Project Conditions AM Intersection Operations Results	34
Table 10: Background with Project Conditions PM Intersection Operations Results.....	35
Table 11: Background with Project Conditions Saturday Intersection Operations Results.....	35
Table 12: Cumulative Conditions Intersection Operations Results	38
Table 13: Cumulative with Project AM Peak Hour Intersection Operations	41
Table 14: Cumulative with Project PM Peak Hour Intersection Operations.....	42
Table 15: Cumulative with Project Saturday Peak Hour Intersection Operations.....	42
Table 16: Existing Conditions Intersection Operations at State Route 1 & California Avenue / Wienke Way.....	50
Table 17: Background Conditions Intersection Operations at State Route 1 & California Avenue / Wienke Way.....	52
Table 18: Parking Requirements for the Project	60
Table 19: Average Estimated Parking Demand for the Project	61
Table 20: Project Area Trips on State Route 92.....	62
Table 21: 95th Percentile Queue Lengths (in Equivalent 25-foot Vehicle Lengths) for Intersections along State Route 1.....	64

APPENDICES

- Appendix 1 SamTrans Service Memo
- Appendix 2 Traffic Count Data
- Appendix 3 Seasonal Adjustment Methodology for Existing Conditions
- Appendix 4 Existing Conditions Level-of-Service Worksheets
- Appendix 5 Existing with Project Conditions Level-of-Service Worksheets
- Appendix 6 Background Conditions Level-of-Service Worksheets
- Appendix 7 Background with Project Level-of-Service Worksheets
- Appendix 8 Cumulative Conditions Level-of-Service Worksheets
- Appendix 9 Cumulative with Project Level-of-Service Worksheets
- Appendix 10 Existing with Project Conditions, Mitigated Level-of-Service Worksheets
- Appendix 11 Roundabout Analysis at State Route 1/ California Avenue / Wienke Way
- Appendix 12 Background with Project Conditions, Mitigated Level-of-Service Worksheets
- Appendix 13 Signal Warrant Analysis
- Appendix 14 Cumulative with Project Conditions, Mitigated Level-of-Service Worksheets
- Appendix 15 U.S. Census Data on Midcoast Residents and Jobs

EXECUTIVE SUMMARY

This report presents the results of the traffic study for the proposed Cypress Point Project, located on the northeast corner of Carlos Street and Sierra Street in the unincorporated community of Moss Beach, San Mateo County, California (Figure 1). The 10.875-acre parcel is currently vacant. The proposed Project includes 71 affordable housing units. Access to the Project site would be provided by a driveway on Carlos Street, near the intersection with Sierra Street.

PROJECT TRIP ESTIMATES

Trip generation of the Project is based on information compiled in the 9th Edition of the Institute of Transportation Engineers (ITE) *Trip Generation* manual¹. The Apartment land use (ITE 220) was used for this study.

As summarized in Table 3, the Project would generate 37 weekday AM peak hour trips, 45 weekday PM peak hour trips, and 37 weekend Saturday midday peak hour trips. Trip generation estimates are presented in Table ES 1. San Mateo County traffic impact guidelines generally only require a traffic report if the project generates over 100 trips during the peak hour. While this project only generates a maximum of 45 peak hour trips, this project is providing a traffic report in the interest of full disclosure.

Table ES 1: Project Trip Generation

Land Use	ITE Code	Unit	Size	AM Peak Hour			PM Peak Hour			Saturday Peak Hour		
				Total	In	Out	Total	In	Out	Total	In	Out
Apartment	220	Dwelling Units	71	37	8	29	45	29	16	37	19	18

Source: ITE *Trip Generation* manual, 9th Edition; Kittelson & Associates, 2018

PROJECT IMPACTS

Table ES 2 presents the results of weekday AM, weekday PM, and Saturday peak hour intersection level of service analysis for the Existing, Existing with Project, Background, Background with Project, Cumulative, and Cumulative with Project conditions—as well as mitigated scenarios for all conditions. Intersection operations results for all scenarios are presented in Table ES 2.

The results of the analysis show significant impacts to the following intersections based on the County's intersection operations standards:

- **State Route 1 & California Avenue/Wienke Way** in Existing with Project PM and Saturday peak hour conditions and in PM and Saturday Background with Project conditions;

¹ Institute of Transportation Engineers. *Trip Generation, 9th Edition*, Washington, D.C. 2012

- **State Route 1 & Carlos Street** in the Background with Project Saturday peak hour conditions and in Cumulative with Project AM, PM, and Saturday peak hour conditions;
- **State Route 1 & 16th Street** in Cumulative with Project PM peak hour conditions; and,
- **State Route 1 & Vallemar Street / Etheldore Street** in Cumulative with Project PM peak hour conditions.

Additionally, this report identifies the following significant impacts:

- The existing corner sight distance at the intersection of State Route 1 and Carlos Street is restricted and the addition of Project traffic will substantially increase the hazard at this intersection.
- The Project will increase pedestrian activity with no existing sidewalks along the Project frontage.
- There is an additional pedestrian impact related to the ability of transit passengers to access the nearest bus stop. The nearest SamTrans bus stop would require pedestrians to cross State Route 1 at a location without a marked pedestrian crossing and inadequate sight distance.

RECOMMENDED IMPROVEMENTS

Change the intersection control at State Route 1 & California Avenue / Wienke Way

The operational analysis shows that a change of intersection control at this intersection would ensure Level of Service (LOS) B or better in all conditions assuming signalization as recommended in San Mateo County's draft *Connect the Coastside* report. A preliminary analysis of changing the intersection control to a roundabout showed a single-lane roundabout option would meet the LOS standard established by the County. However, any change of control at this intersection would be subject to an intersection control evaluation (ICE) report as part of Caltrans procedures; the ICE would compare signal-control and roundabout alternatives to make a final determination on the appropriate intersection control.

Provide Sidewalks along Carlos Street

Providing sidewalks on Carlos Street would connect the project entrance to the existing sidewalk on Sierra Street.

Provide Transit Information to Residents

The Project sponsor should distribute informational literature to tenants upon move-in detailing available transit service and bus stop locations. The informational literature should discourage the use of the southbound bus stop at Carlos Street and State Route 1 because of the inadequate corner sight distance provided at the intersection and the lack of marked crossing across the highway. Residents should be redirected to use the bus stop at Etheldore Street and California Street instead which is approximately a ten-minute walk from the Project entrance.

Table ES 2: Intersection Operations at Study Intersections for all Conditions Analyzed

#	Location	Control	Peak Hour	Existing		Existing + Project		Existing + Project, Mitigated (Signal at SR1 & California Ave)		Background		Background + Project		Background + Project, Mitigated (Signal at SR1 & California Ave)		Cumulative		Cumulative + Project	
				Delay	LOS	Delay	LOS	Delay	LOS	Delay	LOS	Delay	LOS	Delay	LOS	Delay	LOS	Delay	LOS
1	State Route 1 & 14th Street	TWSC	AM	24.4	C	25.1	D	25.1	D	25.4	D	26.1	D	26.1	D	58.2	F	60.6	F
			PM	32.6	D	33.7	D	33.7	D	38.5	E	39.8	E	39.8	E	88.6	F	92.5	F
			Sat.	38.1	E	39.4	E	39.4	E	39.7	E	41.1	E	41.1	E	59.8	F	60.6	F
2	State Route 1 & 16th Street	TWSC	AM	31.0	D	31.7	D	31.7	D	32.3	D	33.2	D	33.2	D	74.7	F	77.5	F
			PM	37.6	E	39.1	E	39.1	E	45.2	E	47.6	E	47.6	E	105.3	F	114.2	F
			Sat.	38.4	E	39.3	E	39.3	E	40.3	E	41.0	E	41.0	E	59.7	F	61.4	F
3	State Route 1 & Carlos Street	TWSC	AM	13.8	B	19.9	C	19.9	C	14.0	B	20.7	C	20.7	C	16.2	C	36.7	E
			PM	13.3	B	27.5	D	27.5	D	14.1	B	32.2	D	32.2	D	18.8	C	64.2	F
			Sat.	14.8	B	32.0	D	32.0	D	15.0	C	45.7	E	45.7	E	19.5	C	72.4	F
4	Carlos Street & Sierra Street	TWSC	AM	8.4	A	8.4	A	8.4	A	8.4	A	8.4	A	8.4	A	8.5	A	8.5	A
			PM	8.7	A	8.7	A	8.7	A	8.7	A	8.7	A	8.7	A	8.8	A	8.8	A
			Sat.	8.6	A	8.6	A	8.6	A	8.6	A	8.6	A	8.6	A	8.6	A	8.6	A
5	Stetson Street & Sierra Street	TWSC	AM	8.6	A	8.6	A	8.6	A	8.6	A	8.6	A	8.6	A	8.7	A	8.7	A
			PM	9.0	A	9.0	A	9.0	A	9.0	A	9.0	A	9.0	A	9.1	A	9.1	A
			Sat.	8.7	A	8.7	A	8.7	A	8.7	A	8.7	A	8.7	A	8.8	A	8.8	A
6	State Route 1 & Vallemar Street / Etheldore Street	TWSC	AM	22.3	C	22.7	C	22.7	C	23.2	C	23.6	C	23.6	C	52.3	F	53.6	F
			PM	37.0	E	38.2	E	38.2	E	44.3	E	46.1	E	46.1	E	106.3	F	112.0	F
			Sat.	31.0	D	31.7	D	31.7	D	32.3	D	33.4	D	33.4	D	34.1	D	35.1	E
7	State Route 1 & California Avenue / Wienke Way	TWSC/Signal	AM	43.5	E	45.6	E	9.9	A	47.4	E	49.9	E	9.9	A	10.3	B	12.2	B
			PM	78.2	F	84.1	F	8.5	A	112.6	F	124.2	F	9.7	A	10.9	B	11.1	B
			Sat.	87.1	F	92.3	F	11.1	B	96.1	F	102.4	F	11.6	B	10.4	B	10.3	B
8	Carlos Street & California Avenue	TWSC	AM	9.8	A	9.8	A	9.8	A	9.8	A	9.8	A	9.8	A	10.0	B	10.0	B
			PM	9.4	A	9.4	A	9.4	A	9.4	A	9.4	A	9.4	A	9.7	A	9.7	A
			Sat.	9.9	A	9.9	A	9.9	A	9.9	A	9.9	A	9.9	A	10.2	B	10.2	B
9	Etheldore Street & California Avenue	TWSC	AM	9.5	A	9.5	A	9.5	A	9.5	A	9.5	A	9.5	A	9.7	A	9.7	A
			PM	9.7	A	9.7	A	9.7	A	9.7	A	9.7	A	9.7	A	9.9	A	9.9	A
			Sat.	9.7	A	9.7	A	9.7	A	9.7	A	9.7	A	9.7	A	10.0	B	10.0	B
10	Stetson Street & California Avenue	AWSC	PM	7.2	A	7.2	A	7.2	A	7.2	A	7.2	A	7.2	A	7.3	A	7.3	A
			PM	7.3	A	7.3	A	7.3	A	7.3	A	7.3	A	7.3	A	7.4	A	7.4	A
			Sat.	7.2	A	7.2	A	7.2	A	7.2	A	7.2	A	7.2	A	7.2	A	7.2	A

Note: **Bold lettering** indicates an intersection that does not meet the County's minimum acceptable design level of service (LOS C, and LOS D for critical movements). Shaded cells represent a significant impact.

AWSC: All-Way Stop Control, TWSC: Two-Way Stop Control. LOS and delay reported for TWSC intersections is for the worst approach or movement; complete intersection operations are provided in Appendixes 4 through 12.

¹"Mitigated" refers to the closure of Carlos Street and associated rerouting of existing and project trips through other intersections within Moss Beach, and (in Existing and Background scenarios) the addition of a traffic signal at State Route 1 & California Avenue/Wienke Way

Source: Highway Capacity Manual 2010; Kittelson & Associates, 2018

INTRODUCTION

This report documents the transportation impact analysis associated with MidPen Housing's affordable housing project located at the corner of Carlos Street and Sierra Street in Moss Beach, San Mateo County, California.

PROJECT DESCRIPTION

The proposed project ("Project") is an affordable housing project located in the coastal zone on a 10.875-acre parcel adjacent to the northeast corner of Carlos Street and Sierra Street in the unincorporated community of Moss Beach, San Mateo County, California (Figure 1 and Figure 3). The property is bounded by vacant land to the southwest (towards State Route 1), residential properties along 16th Street to the northwest (in the community of Montara), and residential properties along Carlos, Sierra, and Lincoln Streets on the other two sides. Individual houses along Stetson Street and Buena Vista Street also border the property.

MidPen proposes the development of 71 affordable housing units on this lot, consisting of approximately 22 two-story buildings holding 2-4 units each (Figure 2). The project would provide a mixture of 1, 2, and 3-bedroom units, including a combination of two-story townhouses and ADA-accessible 1-story flats. All the units, except for the manager's apartment, will be affordable to households earning less than 80% of the Area Median Income (AMI). It is expected that the Cypress Point project will provide housing for approximately 213 people, including adults and children.

In addition to the housing units, the development will include an approximately 3,200 square foot community building, that will include the general office, the manager's office, a community room, kitchen, computer room, laundry, and maintenance and storage areas (Figure 2). The project plan also includes several outdoor amenities, including:

- Landscaping;
- A community garden;
- A children's play area;
- An upper and a lower green;
- BBQ areas; and
- A publicly accessible walking trail.



**Project Vicinity
Moss Beach, California**

**Figure
1**



H:\20200616 - Moss Beach Housing TIA\report\A\draft 2 - 20171221\figures\site plan.mxd - malsion - 10:30 AM 1/10/2018

PROJECT LOCATION AND STUDY AREA

Existing and Proposed Uses

The General Plan designation of the proposed site is Medium-High Density Residential. This allows for development at densities of between 8.8 to 17.4 housing units per acre. The zoning designation of PUD-124/CD traces back to 1986 and was assigned to a proposed Planned Unit Development (PUD) on the site called Farallon Heights. This zoning allows for a total of 148 units on the site, with a density of 13.6 units per acre. The site is designated as Medium-High Density Residential in the San Mateo County Mid-Coast Local Coastal Program (LCP), which allows for development at densities from 8.1 to 16.0 units per acre. The site is defined as infill in the LCP and designated as a priority development site for affordable housing in the San Mateo County Local Coastal Program Policies document (San Mateo County Planning and Building Department 2013). The site is also designated as an affordable housing opportunity site under the San Mateo County Housing Element. (San Mateo County Planning and Building Department 2015)

SCOPE OF STUDY

The purpose of the traffic analysis is to determine whether the Project would have transportation impacts as defined by the San Mateo County transportation study guidelines. The County does not normally require a traffic report for projects that generate fewer than 100 trips during the peak hour but in the interest of full disclosure, this traffic study has been prepared.² The guidelines specify intersection analyses are to be conducted but do not require roadway segment analyses. Since a roadway segment's capacity is generally controlled by the downstream intersection, an intersection analysis is sufficient for assessing a Project's impacts. Based on discussions with County staff, the following ten intersections were identified to be studied (Figure 1):

1. State Route 1 & 14th Street;
2. State Route 1 & 16th Street;
3. State Route 1 & Carlos Street;
4. Carlos Street & Sierra Street;
5. Sierra Street & Stetson Street;
6. State Route 1 & Etheldore Street / Vallemar Street;
7. State Route 1 & California Avenue;
8. Carlos Street & California Avenue;
9. California Avenue & Etheldore Street; and,
10. California Avenue & Stetson Street.

² Page 2, County of San Mateo Traffic Impact Study Requirements (December 9, 2014)

Turning movement counts were collected during the weekday AM and PM peak periods as well as the Saturday midday peak period at the ten study intersections. The counts were conducted on Thursday, April 20, 2017, and Saturday April 22, 2017 in good weather during the school year. Seasonal adjustments were applied to the observed counts to represent higher-volume summer months.

Traffic conditions were evaluated for the following scenarios:

- Existing Conditions;
- Existing with Project Conditions;
- Background Conditions (Existing conditions plus foreseeable projects that were not built or occupied during existing counts);
- Background with Project Conditions;
- Cumulative Conditions (Existing conditions plus the assumed growth in traffic between the existing year and 2040); and,
- Cumulative with Project Conditions.

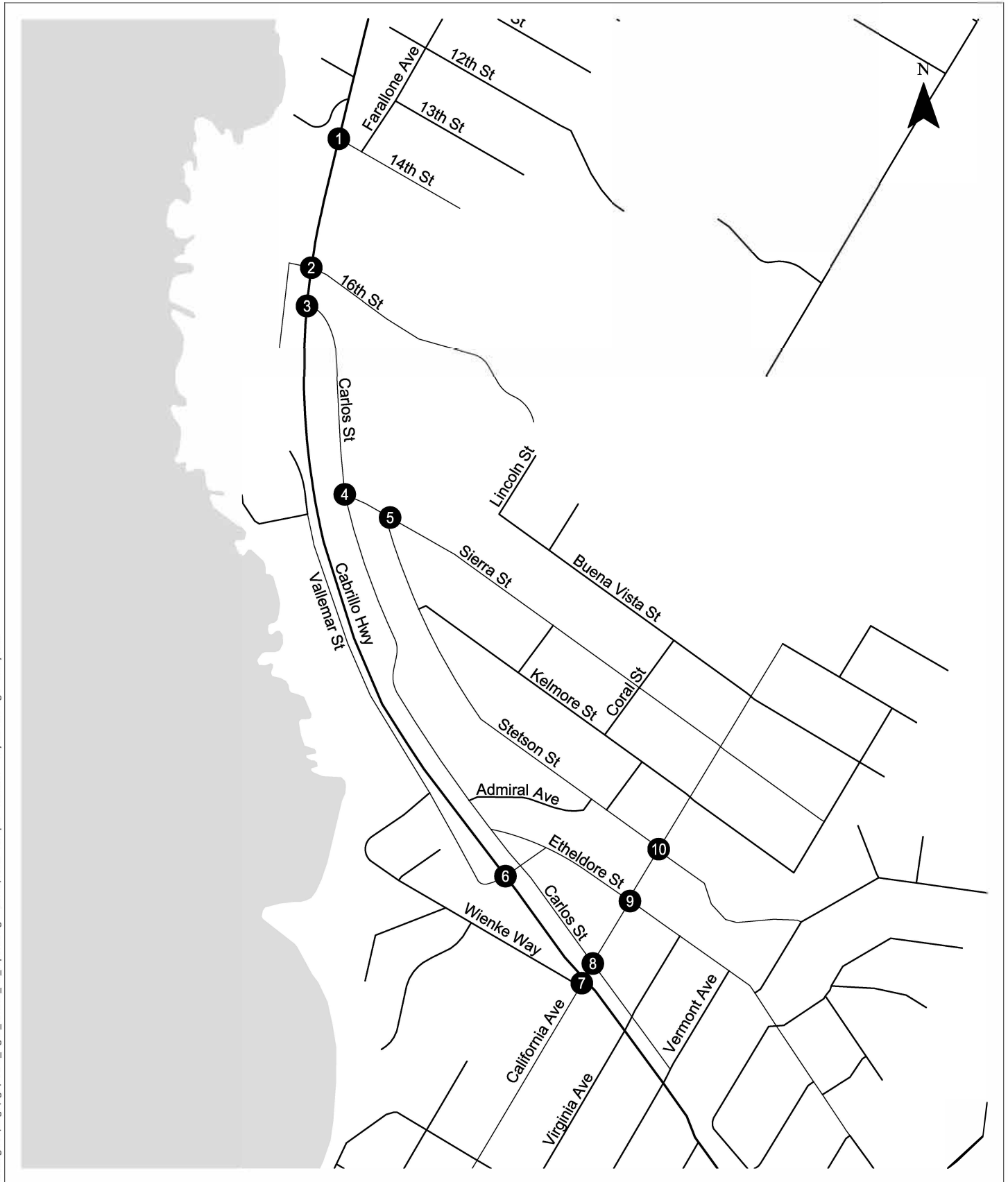

- Study Intersections

Study Area and Study Intersections
Moss Beach, California

Figure
3

H:\20\20616 - Moss Beach Housing TIA\dwgs\Figs\20616 - Fig01_revised_for_report.dwg Jan 10, 2018 - 2:19pm - malston Layout Tab: Fig 3 - Study Area

EXISTING CONDITIONS

ROADWAY NETWORK

Access to the Project site is provided off Carlos Street north of Sierra Street. Carlos Street can either be directly accessed from State Route 1 to the north of the Project or via State Route 1 south of the Project via either Etheldore Street or California Avenue.

State Route 1 in the vicinity is a two-lane highway running north-south. State Route 1 provides the only access to Moss Beach, connecting it to destinations in the north such as San Francisco and to destinations to the south such as Half Moon Bay.

Carlos Street is a narrow two-way local street that runs through Moss Beach parallel to State Route 1. Near the Project site, Carlos Street has no pavement markings, on-street parking, sidewalks, or bicycle accommodations. Further south in the commercial area of Moss Beach near California Avenue, Carlos Street includes bicycle pavement markings, on-street parking and sidewalks on one side.

Etheldore Street is a two-lane, two-way local street that connects Moss Beach to State Route 1. It extends from the study intersection with State Route 1 and Vallemar Street, through Moss Beach, to State Route 1 further south. Etheldore Street includes intermittent paved sidewalks on its south side and no sidewalks on its north side.

California Avenue is a two-lane, two-way local street that crosses State Route 1 south of the Project site, providing State Route 1 access to much of the residential area of Moss Beach. California Avenue in the study area includes paved sidewalks on its west side and no sidewalks on its east side.

Stetson Street is a two-lane, two-way local street that extends from Sierra Street near the Project site to Sunshine Valley Road and provides access across Moss Beach. Stetson Street in the study area includes paved sidewalks on its north side and no sidewalks on its south side.

Sierra Street is a two-lane, two-way local street that extends from Carlos Street to Vermont Street and provides residential access across Moss Beach. In the study area, Sierra Street features paved sidewalks on its north side between Coral Street and California Avenue but no paved sidewalks on any other segments.

The 2011 San Mateo County Comprehensive Bicycle and Pedestrian Plan identified planned bikeways through Moss Beach including along Carlos Street, but cites no existing bicycle facilities in the study area.

TRANSIT SERVICE

The Project site is served by two bus routes (Routes 17 and 18) operated by SamTrans transit service. A description of each route, with the closest stops to the project site, is provided below. All route variations are shown in Figure 4. More detail on SamTrans service through Moss Beach, and the school access provided by this service, is provided in Appendix 1.

Route 17

SamTrans Route 17 follows two different northbound routes and two southbound routes.

Northbound

The weekday morning and weekend all-day northbound route include stops at California Avenue / Etheldore Street (0.47 miles from the project) and State Route 1 / 14th Street (0.23 miles from the project). The weekday afternoon/evening northbound route includes a stop at Etheldore Street / Sunshine Valley Road (0.62 miles from the project).

Collectively, these routes operate hourly from 5:30 a.m. to 9:00 p.m. on weekdays and every other hour from 5:13 a.m. to 7:58 p.m. on weekends.

Southbound

The weekday morning southbound route includes a stop at Etheldore Street / Sunshine Valley Road (0.62 miles from the project). The weekday afternoon/evening southbound route stops at State Route 1 / 16th Street (0.11 miles from the project) and California Avenue / Etheldore Street (0.47 miles from the project). Collectively, these routes operate hourly from 6:18 a.m. to 9:50 p.m. on weekdays and every other hour from 6:16 a.m. to 9:28 p.m. on weekends.

Route 18

SamTrans route 18 operates between Main Street / 7th Street in Montara and Moonridge Apartments near Half Moon Bay. The route travels north-south along Sunshine Valley Road and includes stops (in both directions) at Sunshine Valley Road / Etheldore Street (0.47 miles from the project). Route 18 operates two northbound buses in the morning, two northbound buses in the afternoon, three southbound buses in the morning, and two southbound buses in the afternoon.³

³ There are some exceptions to this generalization of Route 18 service. More information (including some routes which only operate on specific days) can be found at <http://www.samtrans.com/schedulesandmaps/timetables/18.html>.

Transit service to schools

SamTrans service would accommodate project students traveling to and from the project to either Manuel F. Cunha Intermediate School via Routes 17 and 18, or Half Moon Bay High School via Route 18. More information is available in the memo provided in Appendix 1.

TRAFFIC VOLUMES

Multimodal turning movement counts were conducted at the ten study intersections shown in Figure 1 for the weekday AM, weekday PM, and Saturday midday peak periods. These peak periods included the following time periods:

- AM peak hour: 7:00 to 9:00 AM;
- PM peak hour: 4:00 to 6:00 PM; and
- Saturday peak hour: 11:00 AM to 1:00 PM.

The hour with the highest vehicle volumes from each of these periods was used in the transportation analysis.

The collected multimodal turning movement counts are attached in Appendix 2. Because State Route 1 is a seasonal route, the peak hour traffic volumes collected in April were adjusted to be consistent with the typically busier summer months. The method used to increase the counts to be representative of summer traffic, and documentation of the California Department of Transportation's agreement with this methodology, is provided in Appendix 3. The existing intersection geometries and seasonally-adjusted existing volumes are shown in Figure 5 and Figure 6.





**SamTrans Service through Moss Beach
Routes 17 and 18**

**Figure
4**

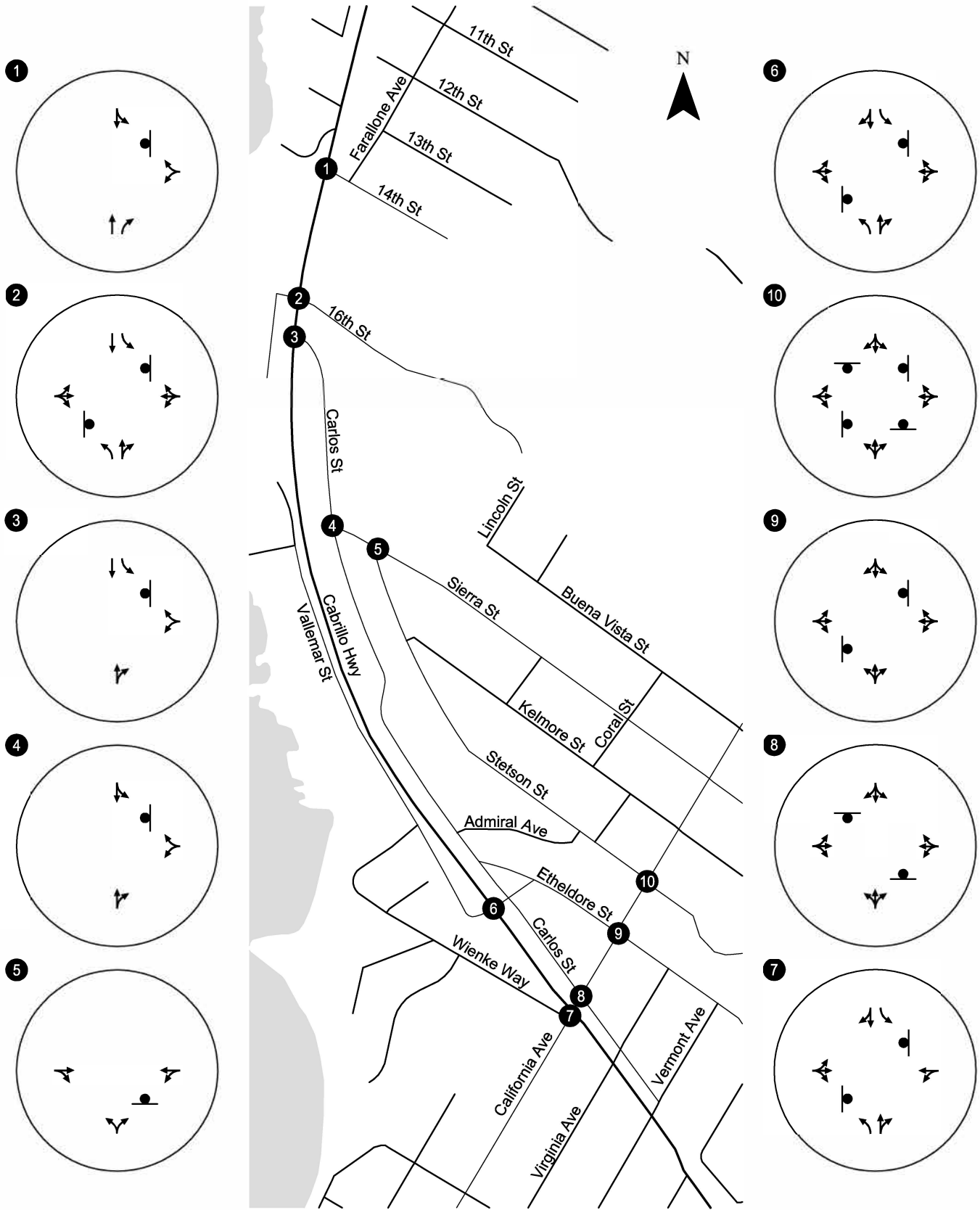
H:\20\20616 - Moss Beach Housing TIA\dwgs\figs\20616_Fig01_revised_for_report.dwg Jan 10, 2018 - 3:02pm - malston Layout Tab, F4 Ex TCDS



-  - STOP SIGN
-  - TRAFFIC SIGNAL

Existing Lane Configurations and
Traffic Control Devices
Moss Beach, California

Figure
5

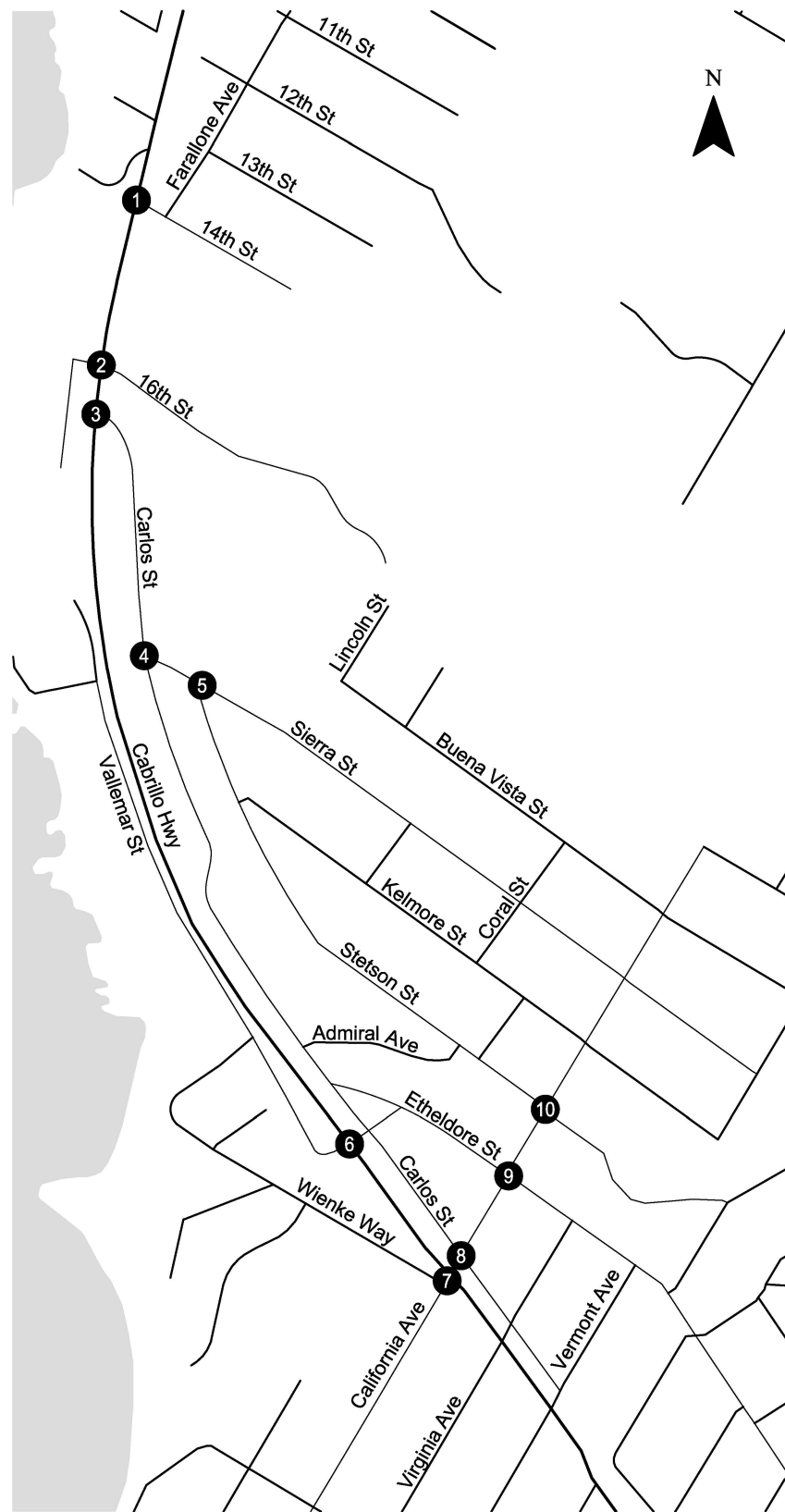

CM = CRITICAL MOVEMENT (UNSIGNALIZED)
 LOS = CRITICAL MOVEMENT LEVEL OF SERVICE (SIGNALIZED)/CRITICAL MOVEMENT LEVEL OF SERVICE (UNSIGNALIZED)
 Del = INTERSECTION AVERAGE CONTROL DELAY (SIGNALIZED)/CRITICAL MOVEMENT CONTROL DELAY (UNSIGNALIZED)
 V/C = CRITICAL CRITICAL VOLUME-TO-CAPACITY RATIO

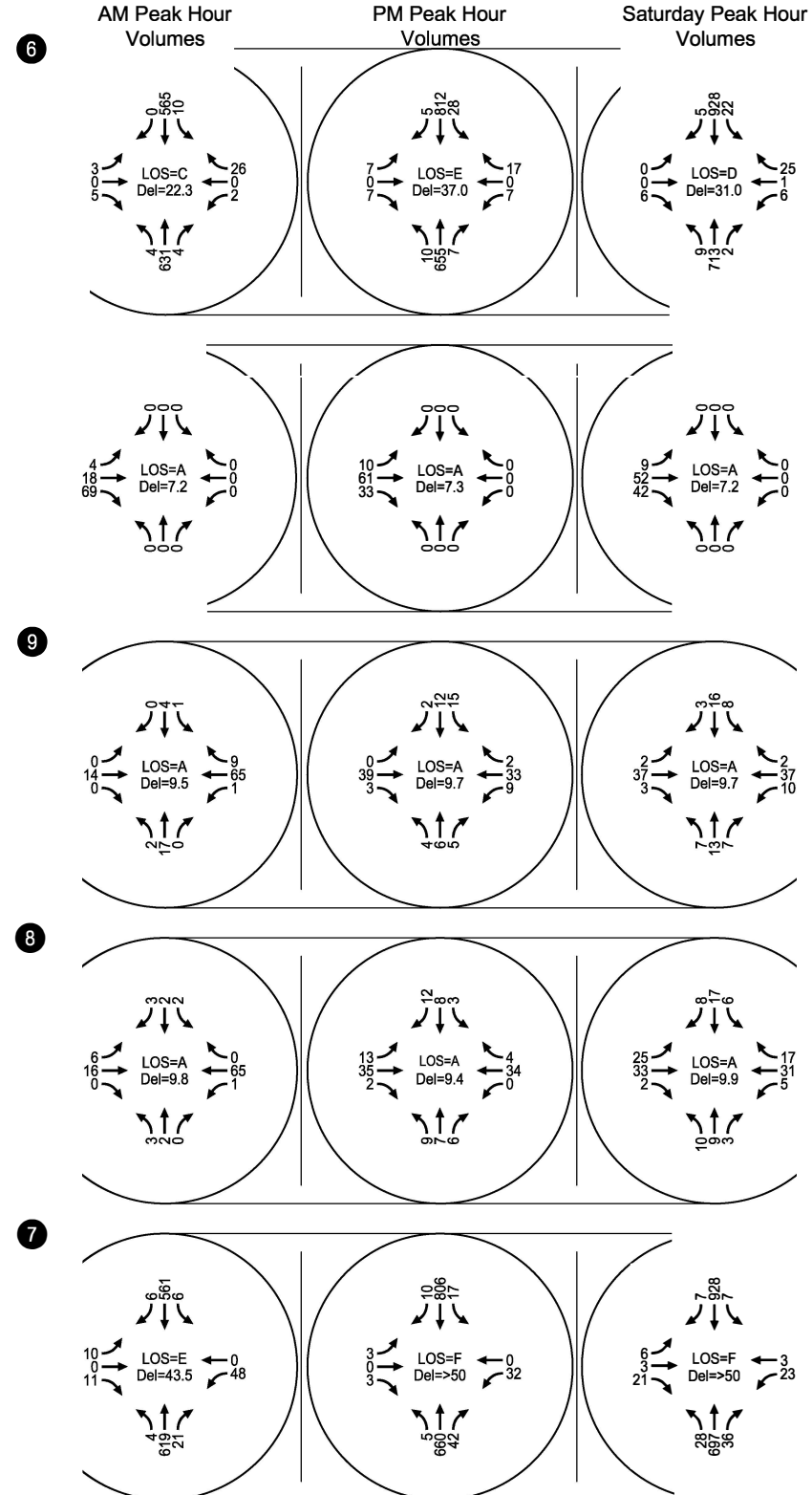
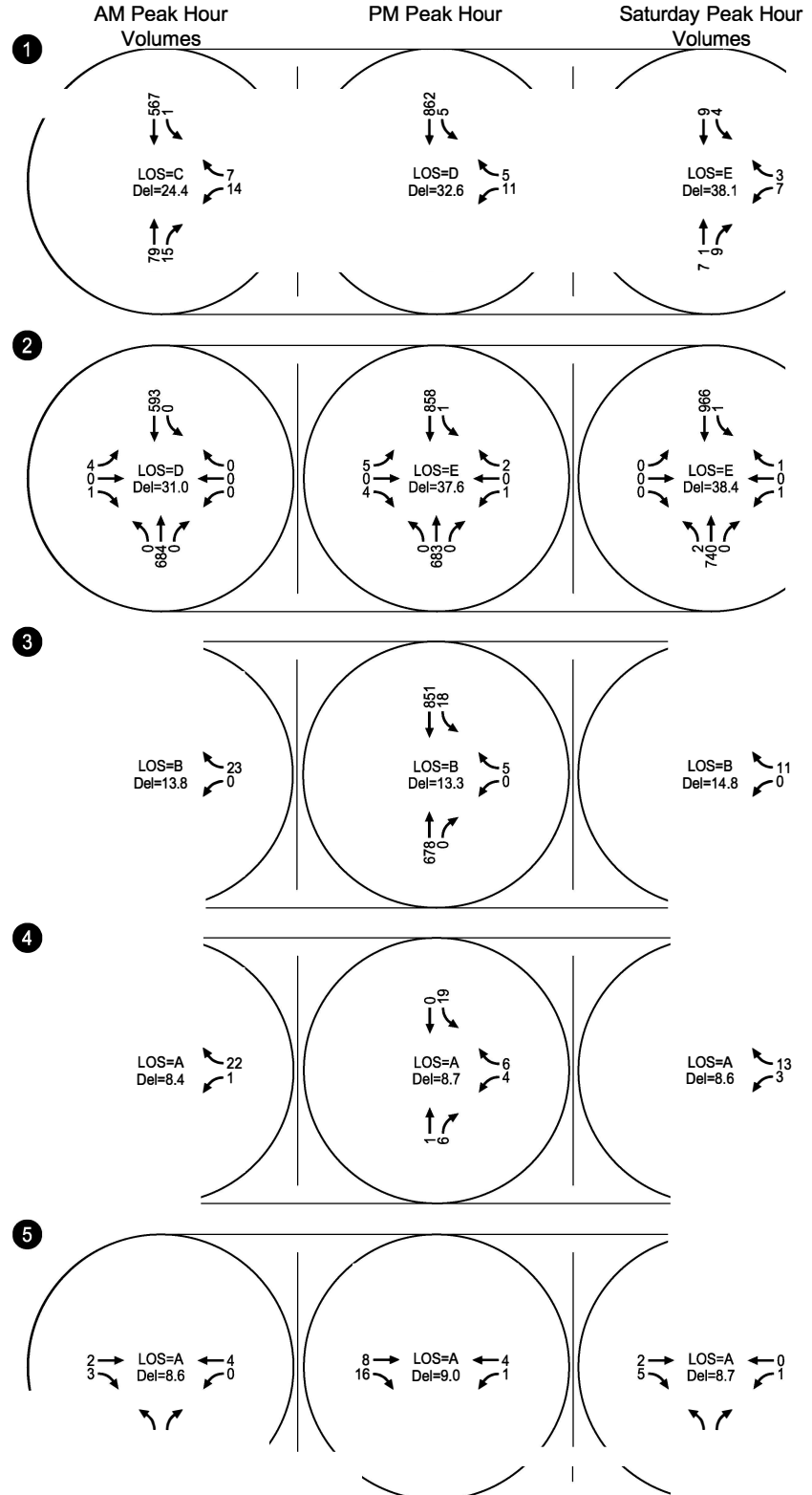

Existing Peak Hour Turning Movement Volumes and Operations
 AM, PM, and Saturday Peak Hour
 Moss Beach, California

Figure 6

INTERSECTION OPERATIONS

Level of service (LOS) describes the operating conditions experienced by motorists. LOS is a qualitative measure of the effect of a number of factors, including speed and travel time, traffic interruptions and delay, freedom to maneuver, driving comfort, and convenience. LOS A through LOS F covers the entire range of traffic operations that might occur. Motorists using a facility that operates at LOS A experience very little delay, while those using a facility that operates at LOS F will experience long delays. Intersection analyses for the ten study intersections were conducted using the operational methodologies outlined in the 2010 Highway Capacity Manual (HCM) (Transportation Research Board, Washington, D.C., 2010).

Signalized intersection. The HCM procedure calculates a weighted average control delay in seconds per vehicle at a signalized intersection and assigns a level of service designation based upon the delay.

Unsignalized intersection. The HCM methodology calculates a weighted average control delay in seconds per vehicle for each controlled intersection leg and for the intersection. A level of service designation for all-way stop-controlled intersections is based upon the weighted average control delay for all intersection legs, similar to the level of service designation for signalized intersections. For two-way stop-controlled intersections, the LOS for the worst approach is used as the LOS performance measure.

Table 1 presents the relationship of average delay to level of service for both signalized and unsignalized intersections.

Table 1: Level of Service Definition for Intersections

Signalized Intersection	LOS	Description of Traffic Conditions	Unsignalized Intersection
Average Delay Per Vehicle (Seconds)			Average Delay Per Vehicle (Seconds)
≤10.0	A	Free flowing. Most vehicles do not have to stop.	≤10.0
>10.0 and ≤20.0	B	Minimal delays. Some vehicles have to stop, although waits are not bothersome.	>10.0 and ≤15.0
>20.0 and ≤35.0	C	Acceptable delays. Significant numbers of vehicles have to stop because of steady, high traffic volumes. Still, many pass without stopping.	>15.0 and ≤25.0
>35.0 and ≤55.0	D	Tolerable delays. Many vehicles have to stop. Drivers are aware of heavier traffic. Cars may have to wait through more than one red light. Queues begin to form, often on more than one approach.	>25.0 and ≤35.0
>55.0 and ≤80.0	E	Significant delays. Cars may have to wait through more than one red light. Long queues form, sometimes on several approaches.	>35.0 and ≤50.0
>80.0	F	Excessive delays. Intersection is jammed. Many cars have to wait through more than one red light, or more than 60 seconds. Traffic may back up into “up-stream” intersections.	>50.0

Source: Transportation Research Board, *Highway Capacity Manual*, Washington, D.C., 2010.

The seasonally-adjusted volumes, lane configurations, and traffic controls for each study intersection were used to assess the Existing conditions LOS and delay. Table 2 shows the findings of this analysis for the AM, PM, and Saturday peak hours. Detailed calculation worksheets showing operations for all intersection movements for the Existing conditions are provided in Appendix 4. These delay and LOS values can be compared to San Mateo County's standards and thresholds, discussed in the next section.

Table 2: Existing Conditions Intersection Operations Results

No	Location	Control	Existing AM		Existing PM		Existing Saturday	
			Delay	LOS	Delay	LOS	Delay	LOS
1	State Route 1 & 14 th Street	TWSC	24.4	C	32.6	D	38.1	E
2	State Route 1 & 16 th Street	TWSC	31.0	D	37.6	E	38.4	E
3	State Route 1 & Carlos Street	TWSC	13.8	B	13.3	B	14.8	B
4	Carlos Street & Sierra Street	TWSC	8.4	A	8.7	A	8.6	A
5	Stetson Street & Sierra Street	TWSC	8.6	A	9.0	A	8.7	A
6	State Route 1 & Vallemar Street / Etheldore Street	TWSC	22.3	C	37.0	E	31.0	D
7	State Route 1 & California Avenue / Wienke Way	TWSC	43.5	E	78.2	F	87.1	F
8	Carlos Street & California Avenue	TWSC	9.8	A	9.4	A	9.9	A
9	Etheldore Street & California Avenue	TWSC	9.5	A	9.7	A	9.7	A
10	Stetson Street & California Avenue	AWSC	7.2	A	7.3	A	7.2	A

Note: **Bold lettering** indicates an intersection that does not meet the County's minimum acceptable design level of service (LOS C overall, and LOS D for critical movements).

AWSC: All-Way Stop Control, TWSC: Two-Way Stop Control. LOS and delay reported for TWSC intersections is for the worst approach or movement; complete intersection operations are provided in Appendix 4.

Source: Highway Capacity Manual 2010; Kittelson & Associates, 2018

TRANSPORTATION IMPACT ANALYSIS

THRESHOLDS OF SIGNIFICANCE

The assessment of the Project is based on transportation impact criteria per the County of San Mateo's Traffic Impact Study Requirements⁴. The County requirements define the LOS standard as follows:

The minimum acceptable design level of service (LOS) in the County is 'C'. At intersections, analyses should show an overall LOS of 'C' with no individual movement operating at less than 'D' to be considered acceptable and not require mitigation measures. On occasion,

⁴ County of San Mateo. *Traffic Impact Study Requirements*. December 9, 2014

level of service 'D' may be allowed for peak periods in dense urban condition per County's discretion.

The Local Coastal Program (LCP) has a different LOS standard that is less stringent than the County's as presented. Thus, this report uses the County's standards for analysis. The Project's impact is not considered to be significant unless it would:

- a. Conflict with an applicable plan, ordinance or policy establishing measures of effectiveness for the performance of the circulation system, taking into account all modes of transportation including mass transit and non-motorized travel and relevant components of the circulation system, including but not limited to intersections, streets, highways and freeways, pedestrian and bicycle paths, and mass transit.

For the purposes of this analysis, the following measures of effectiveness were applied:

Intersection Operations: San Mateo County has established the following performance benchmarks for intersections and roadway segments within its jurisdiction:

- A project will be considered to have a significant impact if the project will cause an intersection to operate at a level of service that violates the overall standard LOS 'C' or where an individual critical movement would operate at worse than LOS 'D'.
 - A project will be considered to have a significant impact if an intersection is operating below the LOS standard without the project, but the project's trips increase the average control delay at any critical movement by four seconds or more.
- b. Substantially increase hazards due to a design feature (e.g., sharp curves or dangerous intersections) or incompatible uses (e.g., farm equipment).

For this study the Project would "substantially increase hazards due to a design feature or incompatible use" if it would:

- Increase traffic volumes for movements that have restricted sight distance for existing posted speeds per Caltrans *Highway Design Manual* standards.

PROJECT ANALYSIS

Trip Generation

Trip generation of the Project is based on information compiled in the 9th Edition of the Institute of Transportation Engineers (ITE) *Trip Generation* manual.⁵ The *Trip Generation* manual does not have trip generation data specific to affordable housing but does have several related uses including: apartment, low-rise apartment, mid-rise apartment, and high-rise apartment. Of these land uses, the Apartment land use (ITE 220) was used for this study because this land use had a larger sample size than the other related uses and had the higher trip generation rates, resulting in a more conservative estimation of trip generation.⁶

The trip generation rates used in this study and presented in the *Trip Generation* manual represent suburban or exurban land use contexts with minimal transit service and ridership. In this sense, these rates are suitable for the Moss Beach context. There are a number of transportation demand strategies that could be employed at this site that may reduce the number of trips associated with the project. For example, the project site plan may be designed to promote walking and bicycling, which would help to reduce short vehicle trips. However, some typical strategies may be limited in effectiveness given the land use context and the relatively small size of the project relative to larger employer-based TDM programs. For example, an on-site shuttle would not likely have an obvious nearby destination or route schedule.

As summarized in Table 3, the Project would generate 37 weekday AM peak hour trips, 45 weekday PM peak hour trips, and 37 weekend Saturday midday peak hour trips.

Table 3: Project Trip Generation

Land Use	ITE Code	Unit	Size	AM Peak Hour			PM Peak Hour			Saturday Peak Hour		
				Total	In	Out	Total	In	Out	Total	In	Out
Apartment	220	Dwelling Units	71	37	8	29	45	29	16	37	19	18

Source: ITE *Trip Generation* manual, 9th Edition; Kittelson & Associates, 2018

⁵ Institute of Transportation Engineers. *Trip Generation, 9th Edition*, Washington, D.C. 2012

⁶ The manual lists Land an average rate of 6.65 weekday trips per dwelling unit for land use ITE 220 (Apartment), 6.59 for ITE 221 (low-rise apartment), 4.20 for ITE 222 (High-Rise Apartment), and no reported daily rate for ITE 223 (Mid-Rise Apartment).

Although the community center onsite may occasionally be used for public events, it will primarily be used by project residents. Therefore, for the purposes of this analysis, the community center onsite is expected only to generate internal trips, not additional trips from outside the Project.

Trip Distribution and Assignment

The distribution of Project trips was derived from existing travel volume data and from knowledge of local travel times. The recorded north/south distribution of traffic along State Route 1 was used to inform the direction that Project traffic would be going to or coming from in order to access the Project site. Access to State Route 1 from the Project was assumed to be via the Carlos Street and State Route 1 intersections. The trip distribution is shown in Table 4. Project only trips are shown in Figure 7.

Table 4: Project Trip Distribution along State Route 1

To/From Project	Direction Along State Route 1	AM Peak Hour	PM Peak Hour	Saturday Peak Hour
Outgoing (from Project)	Northbound	52%	44%	44%
	Southbound	48%	56%	56%
Incoming (to Project)	Northbound (from South)	50%	55%	58%
	Southbound (from North)	50%	45%	42%

Note that outgoing and incoming trips from each time period sum to 100%.
Source: Kittelson & Associates, 2018

H:\20\20616 - Moss Beach Housing TIA\dwg\figs\20616_fig01_revised_for_report.dwg Jan 10, 2018 - 3:04pm - malston Layout Tab: F6 PR

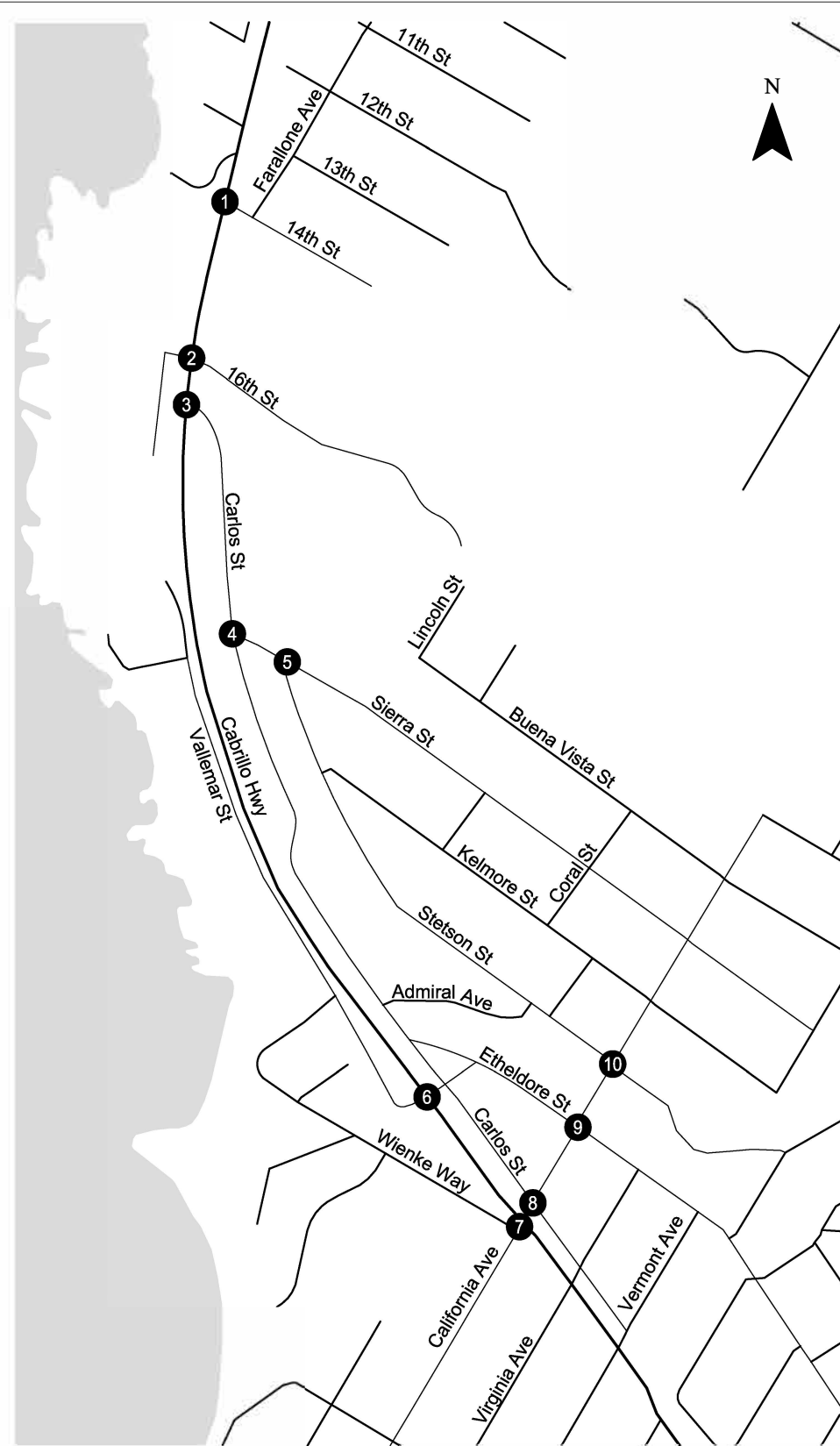

CM = CRITICAL MOVEMENT (UNSIGNALIZED)
 LOS = CRITICAL MOVEMENT LEVEL OF SERVICE (SIGNALIZED)/CRITICAL MOVEMENT LEVEL OF SERVICE (UNSIGNALIZED)
 Del = INTERSECTION AVERAGE CONTROL DELAY (SIGNALIZED)/CRITICAL MOVEMENT CONTROL DELAY (UNSIGNALIZED)
 V/C = CRITICAL CRITICAL VOLUME-TO-CAPACITY RATIO

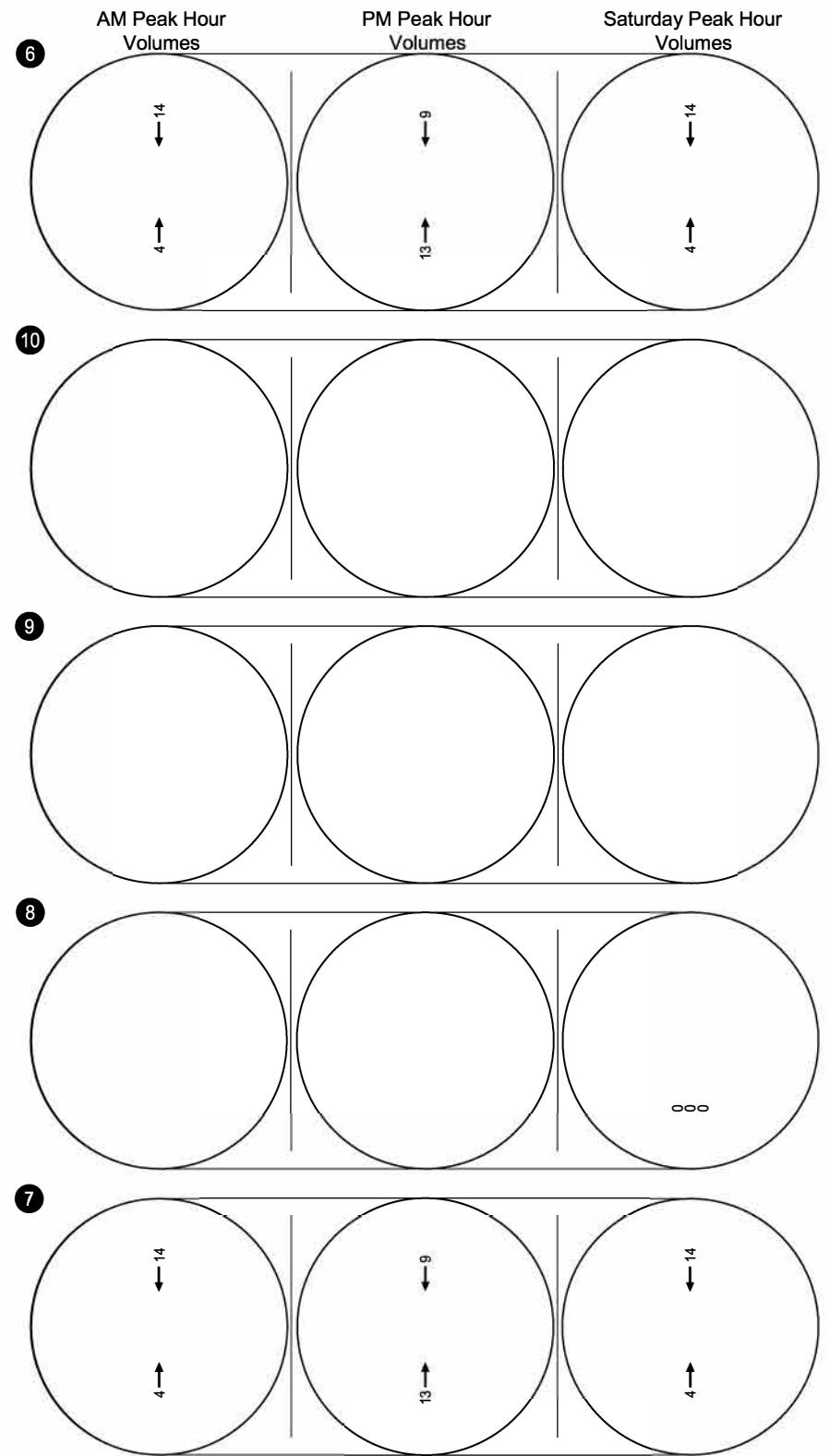
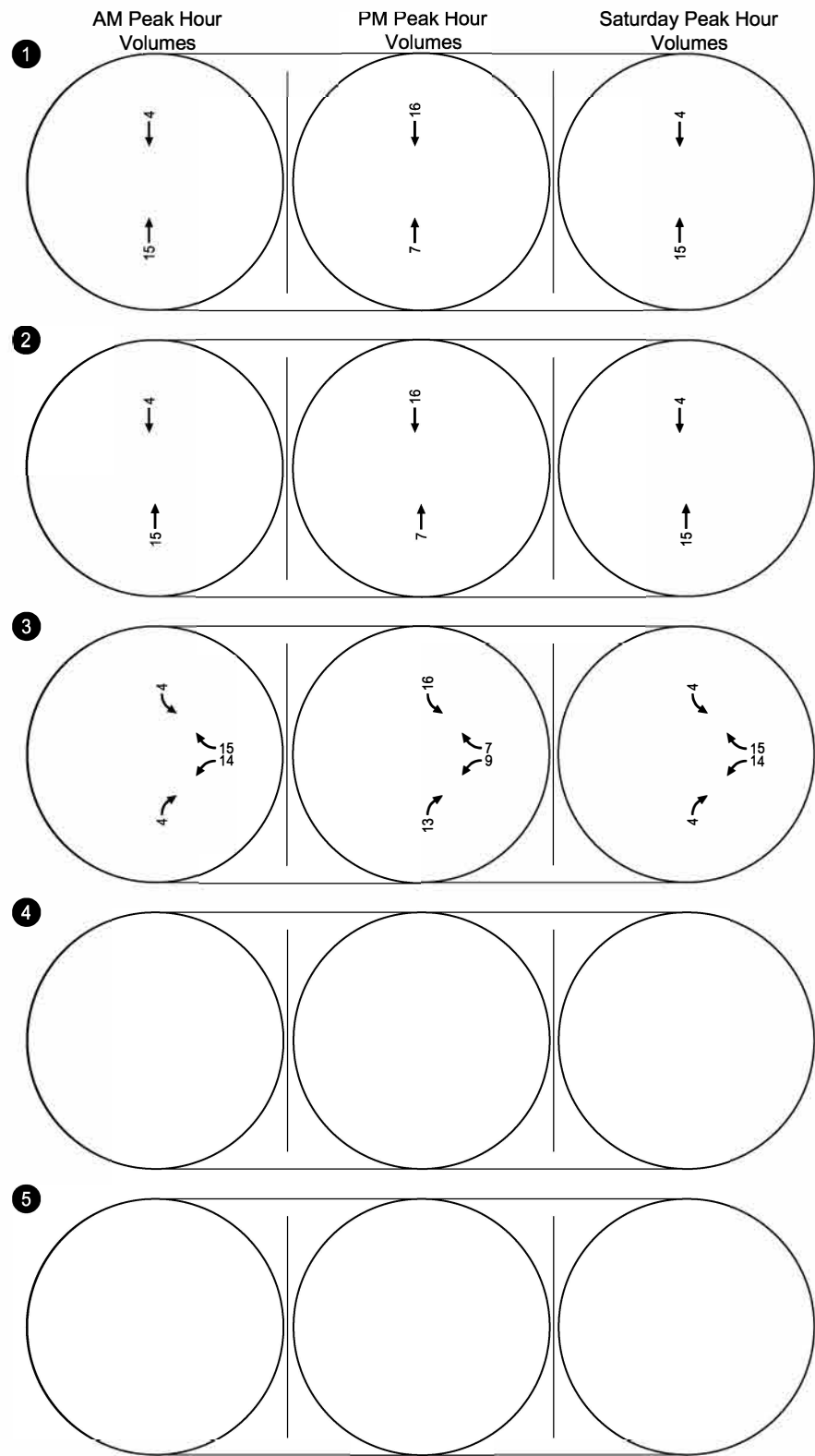

Project Turning Movement Volumes
 AM, PM, and Saturday Peak Hour
 Moss Beach, California

Figure
 7

EXISTING WITH PROJECT OPERATIONS

This section discusses changes to traffic operations at the study intersections upon implementation of the Project.

Intersection Operations

Traffic volumes for the Existing with Project conditions were developed by combining the seasonally-adjusted existing traffic volumes with the Project only volumes. The resulting Existing with Project turning movement volumes are shown in Figure 8. Table 5, Table 6, and Table 7 show the Existing with Project intersection operations for the AM, PM, and Saturday peak hours, respectively. Detailed calculation worksheets for the Existing with Project conditions are provided in Appendix 5. Based on the significance criteria previously described, the Project would cause significant impacts at the following location:

- **Intersection #7 State Route 1 and California Avenue/Wienke Way** – The Project causes the delay for the critical movement to increase by more than 4 seconds during the PM and Saturday peak hours for an intersection already operating below the County’s LOS standard (LOS C).

Proposed mitigations for these impacted intersections are listed in the *CEQA Project Impacts and Proposed Mitigations* section of this report.

Table 5: Existing with Project AM Peak Hour Intersection Operations

No	Location	Control	Existing AM		Existing + Project AM	
			Delay	LOS	Delay	LOS
1	State Route 1 & 14th Street	TWSC	24.4	C	25.1	D
2	State Route 1 & 16th Street	TWSC	31.0	D	31.7	D
3	State Route 1 & Carlos Street	TWSC	13.8	B	19.9	C
4	Carlos Street & Sierra Street	TWSC	8.4	A	8.4	A
5	Stetson Street & Sierra Street	TWSC	8.6	A	8.6	A
6	State Route 1 & Vallemar Street / Etheldore Street	TWSC	22.3	C	22.7	C
7	State Route 1 & California Avenue / Wienke Way	TWSC	43.5	E	45.6	E
8	Carlos Street & California Avenue	TWSC	9.8	A	9.8	A
9	Etheldore Street & California Avenue	TWSC	9.5	A	9.5	A
10	Stetson Street & California Avenue	AWSC	7.2	A	7.2	A

Note: **Bold lettering** indicates an intersection that does not meet the County’s minimum acceptable design level of service (LOS C, and LOS D for critical movements). **Shaded cells** indicate a significant impact.

AWSC: All-Way Stop Control, TWSC: Two-Way Stop Control. LOS and delay reported for TWSC intersections is for the worst approach or movement; complete intersection operations are provided in Appendix 5.

Source: Highway Capacity Manual 2010; Kittelson & Associates, 2018

Table 6: Existing with Project PM Peak Hour Intersection Operations

No	Location	Control	Existing PM		Existing + Project PM	
			Delay	LOS	Delay	LOS
1	State Route 1 & 14th Street	TWSC	32.6	D	33.7	D
2	State Route 1 & 16th Street	TWSC	37.6	E	39.1	E
3	State Route 1 & Carlos Street	TWSC	13.3	B	27.5	D
4	Carlos Street & Sierra Street	TWSC	8.7	A	8.7	A
5	Stetson Street & Sierra Street	TWSC	9.0	A	9.0	A
6	State Route 1 & Vallemar Street / Etheldore Street	TWSC	37.0	E	38.2	E
7	State Route 1 & California Avenue / Wienke Way	TWSC	78.2	F	84.1	F
8	Carlos Street & California Avenue	TWSC	9.4	A	9.4	A
9	Etheldore Street & California Avenue	TWSC	9.7	A	9.7	A
10	Stetson Street & California Avenue	AWSC	7.3	A	7.3	A

Note: **Bold lettering** indicates an intersection that does not meet the County's minimum acceptable design level of service (LOS C, and LOS D for critical movements). **Shaded cells** indicate a significant impact.

AWSC: All-Way Stop Control, TWSC: Two-Way Stop Control. LOS and delay reported for TWSC intersections is for the worst approach or movement; complete intersection operations are provided in Appendix 5.

Source: Highway Capacity Manual 2010; Kittelson & Associates, 2018

Table 7: Existing with Project Saturday Peak Hour Intersection Operations

No	Location	Control	Existing Saturday		Existing + Project Saturday	
			Delay	LOS	Delay	LOS
1	State Route 1 & 14th Street	TWSC	38.1	E	39.4	E
2	State Route 1 & 16th Street	TWSC	38.4	E	39.3	E
3	State Route 1 & Carlos Street	TWSC	14.8	B	32.0	D
4	Carlos Street & Sierra Street	TWSC	8.6	A	8.6	A
5	Stetson Street & Sierra Street	TWSC	8.7	A	8.7	A
6	State Route 1 & Vallemar Street / Etheldore Street	TWSC	31.0	D	31.7	D
7	State Route 1 & California Avenue / Wienke Way	TWSC	87.1	F	92.3	F
8	Carlos Street & California Avenue	TWSC	9.9	A	9.9	A
9	Etheldore Street & California Avenue	TWSC	9.7	A	9.7	A
10	Stetson Street & California Avenue	AWSC	7.2	A	7.2	A

Note: **Bold lettering** indicates an intersection that does not meet the County's minimum acceptable design level of service (LOS C, and LOS D for critical movements). **Shaded cells** indicate a significant impact.

AWSC: All-Way Stop Control, TWSC: Two-Way Stop Control. LOS and delay reported for TWSC intersections is for the worst approach or movement; complete intersection operations are provided in Appendix 5.

Source: Highway Capacity Manual 2010; Kittelson & Associates, 2018

H:\20\20616 - Moss Beach Housing TIA\dwg\figs\20616_fig01_revised_for_report.dwg Jan 10, 2018 - 3:05pm - malston Layout Tab: F7 Ex: P

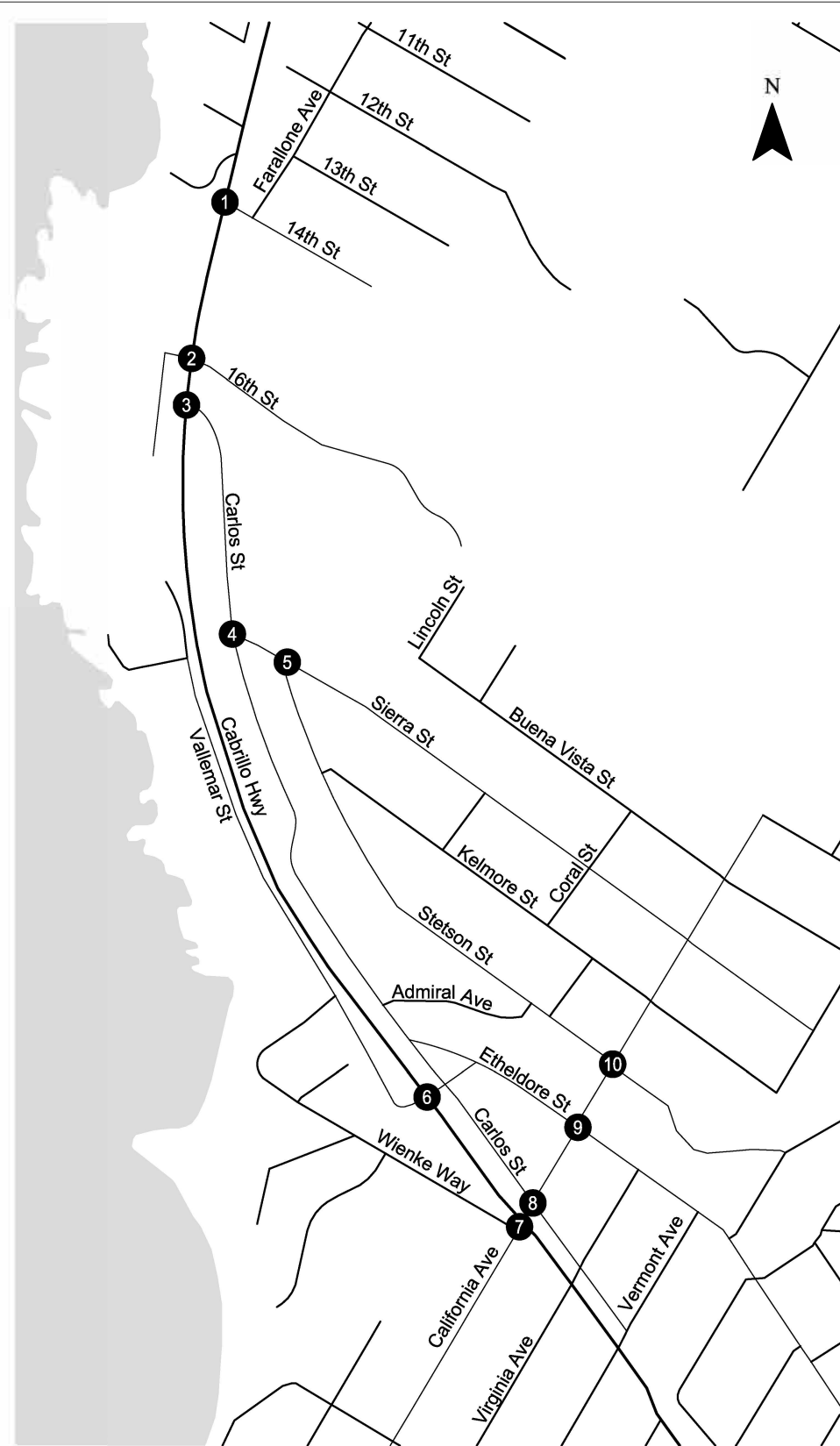

CM = CRITICAL MOVEMENT (UNSIGNALIZED)
 LOS = CRITICAL MOVEMENT LEVEL OF SERVICE (SIGNALIZED)/CRITICAL MOVEMENT LEVEL OF SERVICE (UNSIGNALIZED)
 Del = INTERSECTION AVERAGE CONTROL DELAY (SIGNALIZED)/CRITICAL MOVEMENT CONTROL DELAY (UNSIGNALIZED)
 V/C = CRITICAL CRITICAL VOLUME-TO-CAPACITY RATIO

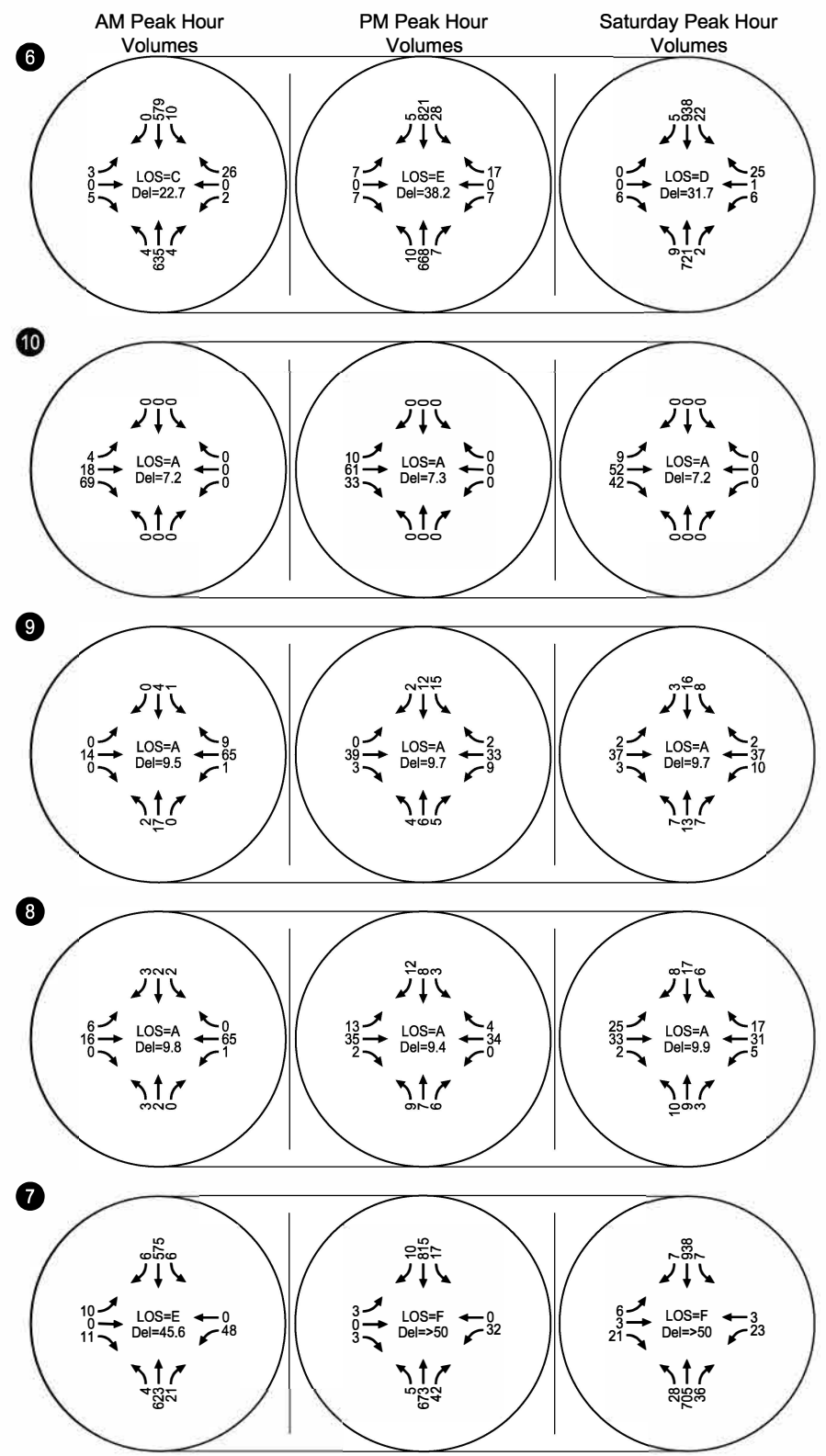
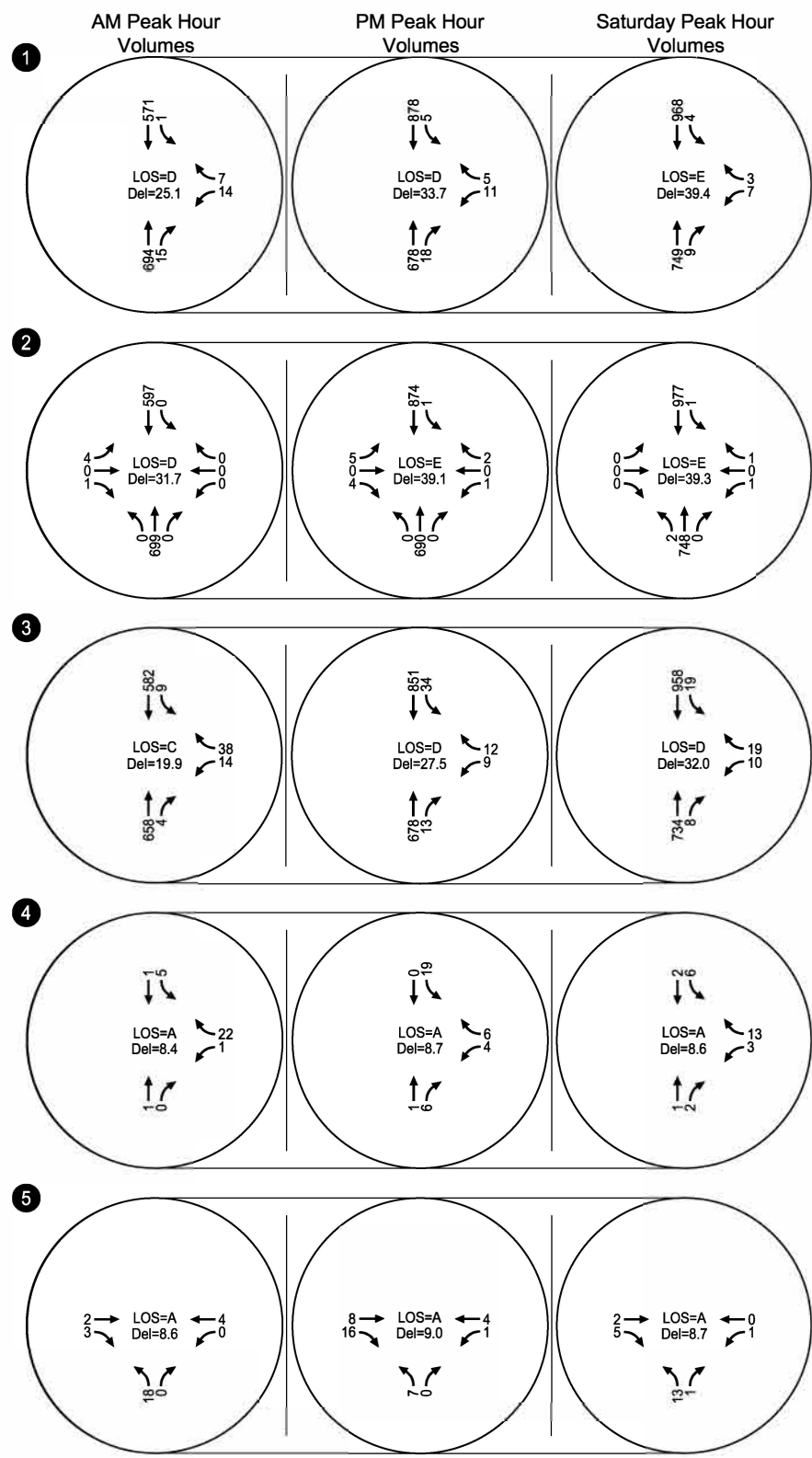

Existing with Project Turning Movement Volumes and Operations
 AM, PM, and Saturday Peak Hour
 Moss Beach, California

Figure 8

BACKGROUND CONDITIONS

This section describes near-term traffic conditions representing conditions when the Project is anticipated to be complete. The Background conditions represent Existing conditions turning movement volumes plus other projects that have been approved or are in the entitlement process but not yet constructed at the time of the traffic counts.

Background No Project Conditions

Based on discussions with the San Mateo County Planning and Building Department, the following projects were identified for inclusion in the background traffic volume. These projects have either been approved but not constructed or are in the entitlement process. Additionally, these projects are of a sufficient size that their traffic may have more than a negligible effect on existing traffic operations.

- An RV park with 50 spaces and seven tent camping spaces, a single-story 832 square foot laundry and restroom facility, landscape, and drainage improvements; located at the corner of State Route 1 and Capistrano Road in Princeton (PLN2017-00320, associated with PRE2015-00019).
- Big Wave, a project that includes a 70,500 square-foot Wellness Center with housing for developmentally disabled adults and their aides, 161,263 square feet of office/industrial park, and free public parking for beach access and a gated boat storage yard. This project is located on Airport Street north of the Princeton/Pillar Point Harbor area in unincorporated San Mateo County. It has been approved but not constructed.

The anticipated trip generation for these two projects was added to the existing seasonally adjusted traffic volumes. The resulting Background conditions turning movement volumes are shown in Figure 9. The Background operations at the study intersections are shown in Table 8. Detailed calculation worksheets for the Background Conditions are provided in Appendix 6.

Table 8: Background Conditions Intersection Operations Results

No	Location	Control	Background AM		Background PM		Background Saturday	
			Delay	LOS	Delay	LOS	Delay	LOS
1	State Route 1 & 14th Street	TWSC	25.4	D	38.5	E	39.7	E
2	State Route 1 & 16th Street	TWSC	32.3	D	45.2	E	40.3	E
3	State Route 1 & Carlos Street	TWSC	14.0	B	14.1	B	15.0	C
4	Carlos Street & Sierra Street	TWSC	8.4	A	8.7	A	8.6	A
5	Stetson Street & Sierra Street	TWSC	8.6	A	9.0	A	8.7	A
6	State Route 1 & Vallemar Street / Etheldore Street	TWSC	23.2	C	44.3	E	32.3	D
7	State Route 1 & California Avenue / Wienke Way	TWSC	47.4	E	112.6	F	96.1	F
8	Carlos Street & California Avenue	TWSC	9.8	A	9.4	A	9.9	A
9	Etheldore Street & California Avenue	TWSC	9.5	A	9.7	A	9.7	A
10	Stetson Street & California Avenue	AWSC	7.2	A	7.3	A	7.2	A

Note: **Bold lettering** indicates an intersection that does not meet the County's minimum acceptable design level of service (LOS C, and LOS D for critical movements).

AWSC: All-Way Stop Control, TWSC: Two-Way Stop Control. LOS and delay reported for TWSC intersections is for the worst approach or movement; complete intersection operations are provided in Appendix 6.

Source: Highway Capacity Manual 2010; Kittelson & Associates, 2018

H:\20\20616 - Moss Beach Housing TIA\dwg\figs\20616_fig01_revised_for_report.dwg Jan 10, 2018 - 3:06pm - malston Layout Tab: F8 BK6

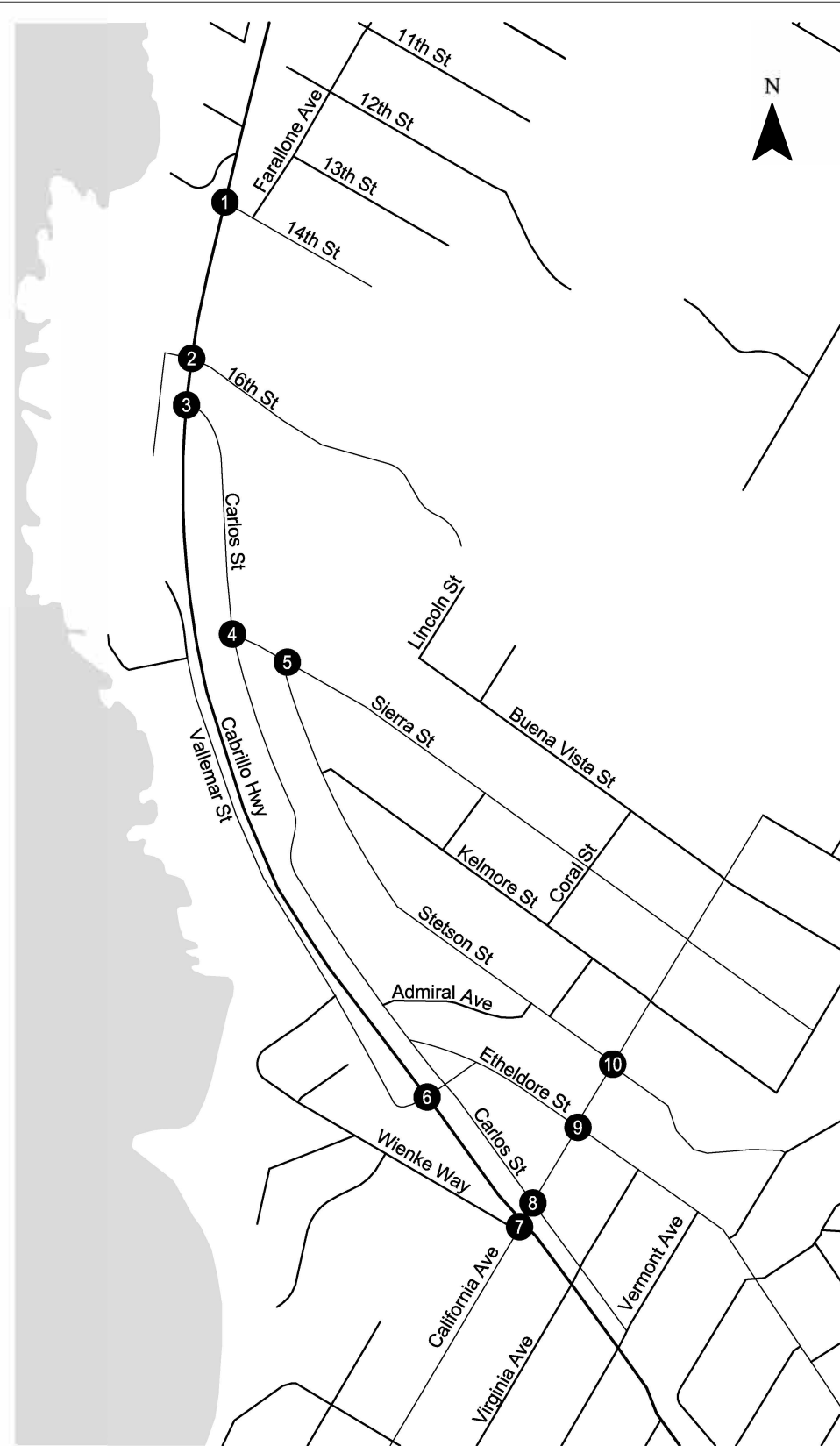

CM = CRITICAL MOVEMENT (UNSIGNALIZED)
 LOS = CRITICAL MOVEMENT LEVEL OF SERVICE (SIGNALIZED)/CRITICAL MOVEMENT LEVEL OF SERVICE (UNSIGNALIZED)
 Del = INTERSECTION AVERAGE CONTROL DELAY (SIGNALIZED)/CRITICAL MOVEMENT CONTROL DELAY (UNSIGNALIZED)
 V/C = CRITICAL CRITICAL VOLUME-TO-CAPACITY RATIO

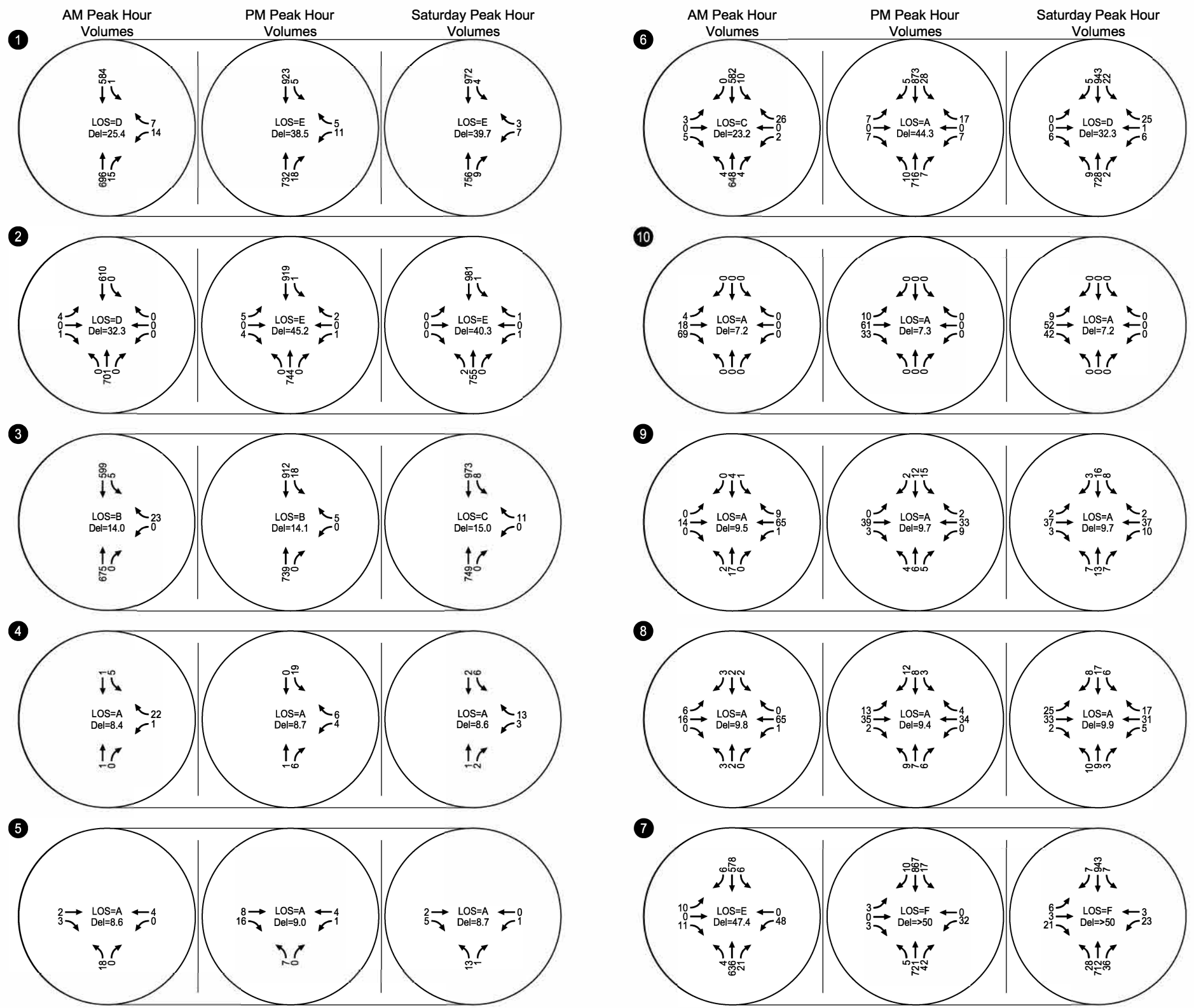

Background Conditions Turning Movement Volumes and Operations
 AM, PM, and Saturday Peak Hour
 Moss Beach, California

Figure 9

Background with Project Conditions

This section discusses changes to traffic operations at the study intersections upon implementation of the Project. Traffic volumes for the Background with Project conditions were developed by combining Background conditions volumes with the Project only volumes. The resulting Background with Project turning movement volumes are shown in Figure 10.

Table 9, Table 10, and Table 11 show the Background with Project intersection operations for the AM, PM, and Saturday peak hours, respectively. Detailed calculation worksheets for the Background with Project conditions are provided in Appendix 7. Based on the significance criteria previously described, the Project would cause significant impacts at the following locations:

- **Intersection #3: State Route 1 and Carlos Street** – The addition of Project trips causes the critical movement at the intersection to degrade below the LOS 'D' standard during the Saturday peak hour.
- **Intersection #7: State Route 1 and California Avenue/Wienke Way** – The addition of Project trips increases delay for the critical movement at the intersection already exceeding the LOS standard by at least 4 seconds per vehicle during the PM and Saturday peak hours.

Proposed mitigations for these impacted intersections are listed in the *CEQA Project Impacts and Proposed Mitigations* section of this report.

Table 9: Background with Project Conditions AM Intersection Operations Results

No	Location	Control	Background AM		Background + Project AM	
			Delay	LOS	Delay	LOS
1	State Route 1 & 14th Street	TWSC	25.4	D	26.1	D
2	State Route 1 & 16th Street	TWSC	32.3	D	33.2	D
3	State Route 1 & Carlos Street	TWSC	14	B	20.7	C
4	Carlos Street & Sierra Street	TWSC	8.4	A	8.4	A
5	Stetson Street & Sierra Street	TWSC	8.6	A	8.6	A
6	State Route 1 & Vallemar Street / Etheldore Street	TWSC	23.2	C	23.6	C
7	State Route 1 & California Avenue / Wienke Way	TWSC	47.4	E	49.9	E
8	Carlos Street & California Avenue	TWSC	9.8	A	9.8	A
9	Etheldore Street & California Avenue	TWSC	9.5	A	9.5	A
10	Stetson Street & California Avenue	AWSC	7.2	A	7.2	A

Note: **Bold lettering** indicates an intersection that does not meet the County's minimum acceptable design level of service (LOS C, and LOS D for critical movements). **Shaded cells** indicate a significant impact.

AWSC: All-Way Stop Control, TWSC: Two-Way Stop Control. LOS and delay reported for TWSC intersections is for the worst approach or movement; complete intersection operations are provided in Appendix 7.

Source: Highway Capacity Manual 2010; Kittelson & Associates, 2018

Table 10: Background with Project Conditions PM Intersection Operations Results

No	Location	Control	Background PM		Background + Project PM	
			Delay	LOS	Delay	LOS
1	State Route 1 & 14th Street	TWSC	38.5	E	39.8	E
2	State Route 1 & 16th Street	TWSC	45.2	E	47.6	E
3	State Route 1 & Carlos Street	TWSC	14.1	B	32.2	D
4	Carlos Street & Sierra Street	TWSC	8.7	A	8.7	A
5	Stetson Street & Sierra Street	TWSC	9.0	A	9.0	A
6	State Route 1 & Vallemar Street / Etheldore Street	TWSC	44.3	E	46.1	E
7	State Route 1 & California Avenue / Wienke Way	TWSC	112.6	F	124.2	F
8	Carlos Street & California Avenue	TWSC	9.4	A	9.4	A
9	Etheldore Street & California Avenue	TWSC	9.7	A	9.7	A
10	Stetson Street & California Avenue	AWSC	7.3	A	7.3	A

Note: **Bold lettering** indicates an intersection that does not meet the County's minimum acceptable design level of service (LOS C, and LOS D for critical movements). **Shaded cells** indicate a significant impact.

AWSC: All-Way Stop Control, TWSC: Two-Way Stop Control. LOS and delay reported for TWSC intersections is for the worst approach or movement; complete intersection operations are provided in Appendix 7.

Source: Highway Capacity Manual 2010; Kittelson & Associates, 2018

Table 11: Background with Project Conditions Saturday Intersection Operations Results

No	Location	Control	Background Saturday		Background + Project Saturday	
			Delay	LOS	Delay	LOS
1	State Route 1 & 14th Street	TWSC	39.7	E	41.1	E
2	State Route 1 & 16th Street	TWSC	40.3	E	41.0	E
3	State Route 1 & Carlos Street	TWSC	15.0	C	45.7	E
4	Carlos Street & Sierra Street	TWSC	8.6	A	8.6	A
5	Stetson Street & Sierra Street	TWSC	8.7	A	8.7	A
6	State Route 1 & Vallemar Street / Etheldore Street	TWSC	32.3	D	33.4	D
7	State Route 1 & California Avenue / Wienke Way	TWSC	96.1	F	102.4	F
8	Carlos Street & California Avenue	TWSC	9.9	A	9.9	A
9	Etheldore Street & California Avenue	TWSC	9.7	A	9.7	A
10	Stetson Street & California Avenue	AWSC	7.2	A	7.2	A

Note: **Bold lettering** indicates an intersection that does not meet the County's minimum acceptable design level of service (LOS C, and LOS D for critical movements). **Shaded cells** indicate a significant impact.

AWSC: All-Way Stop Control, TWSC: Two-Way Stop Control. LOS and delay reported for TWSC intersections is for the worst approach or movement; complete intersection operations are provided in Appendix 7.

Source: Highway Capacity Manual 2010; Kittelson & Associates, 2018

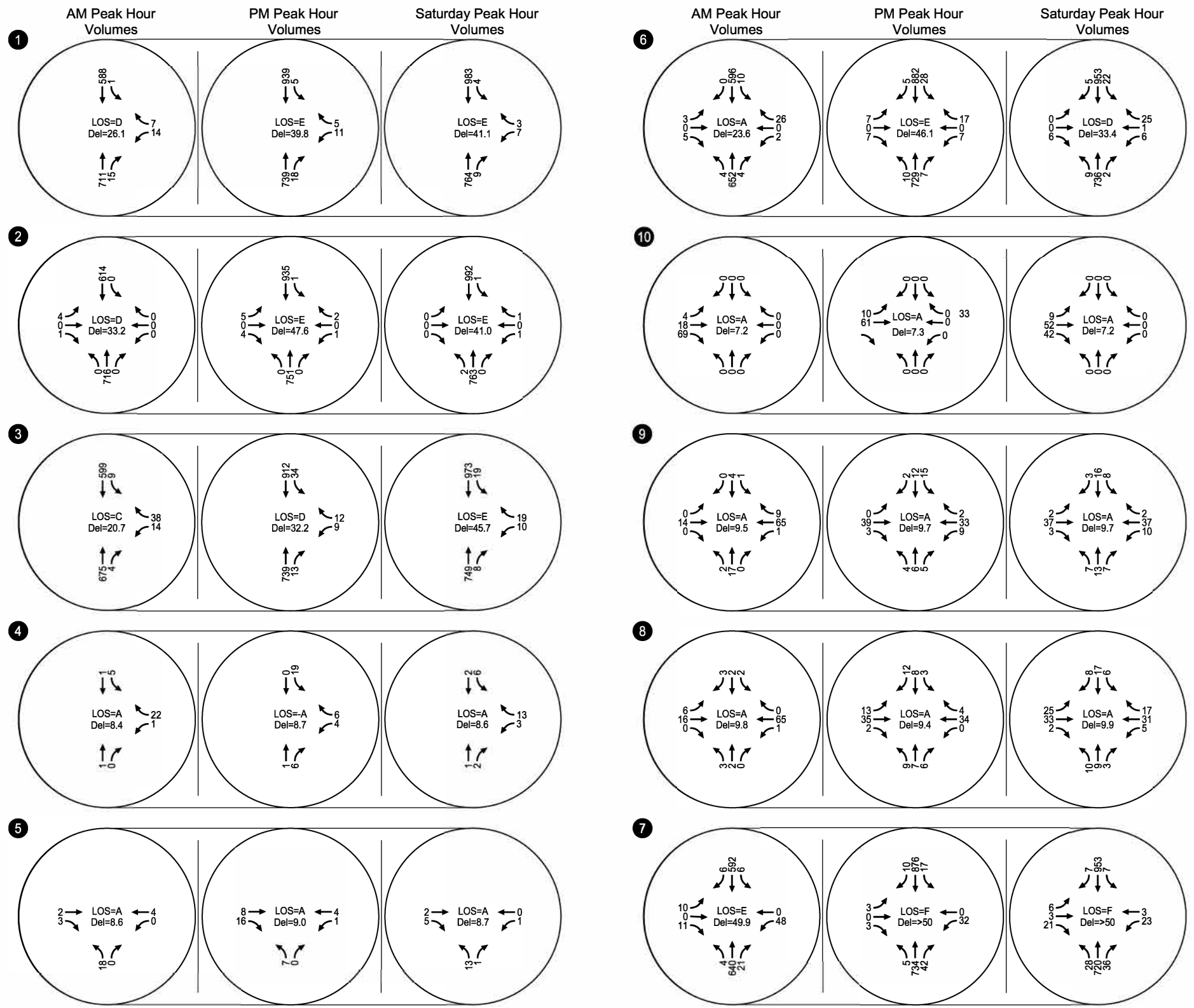
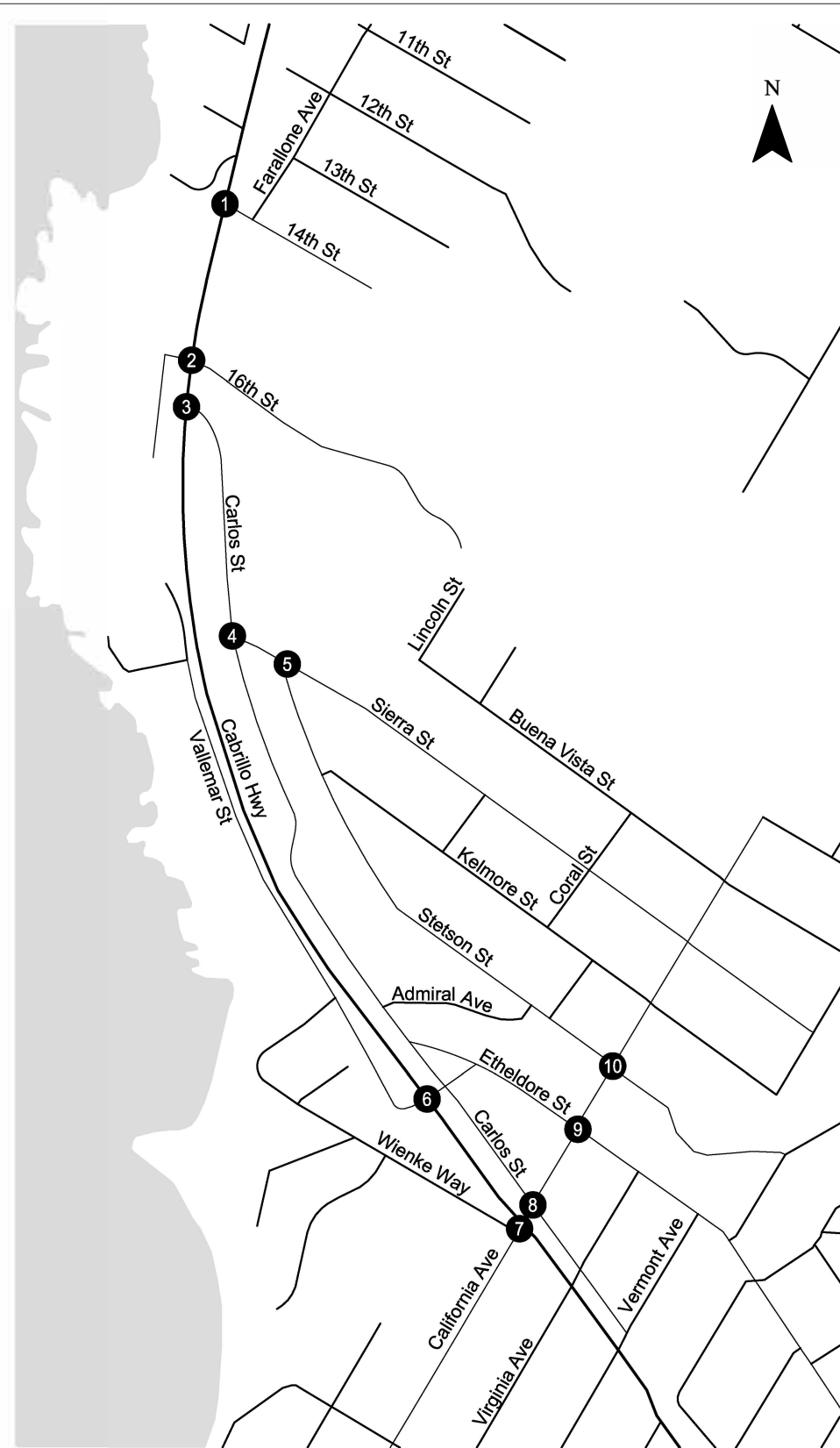

CM = CRITICAL MOVEMENT (UNSIGNALIZED)
 LOS = CRITICAL MOVEMENT LEVEL OF SERVICE (SIGNALIZED)/CRITICAL MOVEMENT LEVEL OF SERVICE (UNSIGNALIZED)
 Del = INTERSECTION AVERAGE CONTROL DELAY (SIGNALIZED)/CRITICAL MOVEMENT CONTROL DELAY (UNSIGNALIZED)
 V/C = CRITICAL CRITICAL VOLUME-TO-CAPACITY RATIO

Background with Project Turning Movement Volumes and Operations AM, PM, and Saturday Peak Hour Moss Beach, California

Figure 10

H:\2016-16-Moss Beach Housing TIA\dwg\figs\20616_fig01_revised_for_report.dwg an 10 2018 - 3:07pm - malston Layout Tab: F9 BKGP-PR

CUMULATIVE CONDITIONS

This section presents the anticipated Cumulative conditions for the study intersections for the year 2040 and the effect the addition of the Project trips would have on them.

The C/CAG-VTA San Mateo County Travel Demand Model was used to develop the future volume forecast for Cumulative Conditions. The model includes future development throughout the region. The 2040 cumulative forecasts are consistent with regional growth totals projected by the Association of Bay Area Governments (ABAG) Plan Bay Area.⁷ Therefore, the traffic forecasts reflect both growth in Moss Beach and increases in traffic volumes on State Route 1 due to regional growth. Base year (Year 2013) and future year (Year 2040) forecasts were extracted from the model and linearly interpolated to develop growth between the traffic count year (2017) and the current model horizon year (2040).

The cumulative conditions analysis assumes the intersection of State Route 1 and California Avenue/Wienke Way will be converted from a stop-controlled intersection to a signalized one based on the *Connect the Coastside* draft report. County staff agreed that this was a reasonably foreseeable project by the year 2040 and should therefore be considered in this analysis. Money to implement this signal, while not currently allocated, may be available from Measure W, which is a half-cent sales tax measure to fund transportation projects in San Mateo County. While this intersection was analyzed in this traffic study as a signalized intersection based on existing plans, the final control (signal, roundabout, etc.) will be determined during an intersection control evaluation (ICE) that will be completed for Caltrans during the design phase. The assumed traffic control devices and lane configurations under Cumulative conditions for all study intersections are shown in Figure 11.

Cumulative No Project Conditions

The projected turning movement volumes for each peak hour under Cumulative conditions are provided in Figure 12. Based on these volumes and lane configurations, the Cumulative operations at the study intersections are shown in Table 12. Detailed calculation worksheets for the Cumulative conditions are provided in Appendix 8.

⁷ <https://mtc.ca.gov/our-work/plans-projects/plan-bay-area-2040>

Table 12: Cumulative Conditions Intersection Operations Results

No	Location	Control	Cumulative AM		Cumulative PM		Cumulative Saturday	
			Delay	LOS	Delay	LOS	Delay	LOS
1	State Route 1 & 14th Street	TWSC	58.2	F	88.6	F	59.8	F
2	State Route 1 & 16th Street	TWSC	74.7	F	105.3	F	59.7	F
3	State Route 1 & Carlos Street	TWSC	16.2	C	18.8	C	19.5	C
4	Carlos Street & Sierra Street	TWSC	8.5	A	8.8	A	8.6	A
5	Stetson Street & Sierra Street	TWSC	8.7	A	9.1	A	8.8	A
6	State Route 1 & Vallemar Street / Etheldore Street	TWSC	52.3	F	106.3	F	34.1	D
7	State Route 1 & California Avenue / Wienke Way	Signal	10.3	B	10.9	B	10.4	B
8	Carlos Street & California Avenue	TWSC	10.0	B	9.7	A	10.2	B
9	Etheldore Street & California Avenue	TWSC	9.7	A	9.9	A	10.0	B
10	Stetson Street & California Avenue	AWSC	7.3	A	7.4	A	7.2	A



Note: **Bold lettering** indicates an intersection that does not meet the County's minimum acceptable design level of service (LOS C, and LOS D for critical movements).

AWSC: All-Way Stop Control, TWSC: Two-Way Stop Control. LOS and delay reported for TWSC intersections is for the worst approach or movement; complete intersection operations are provided in Appendix 8.

Source: Highway Capacity Manual 2010; Kittelson & Associates, 2018

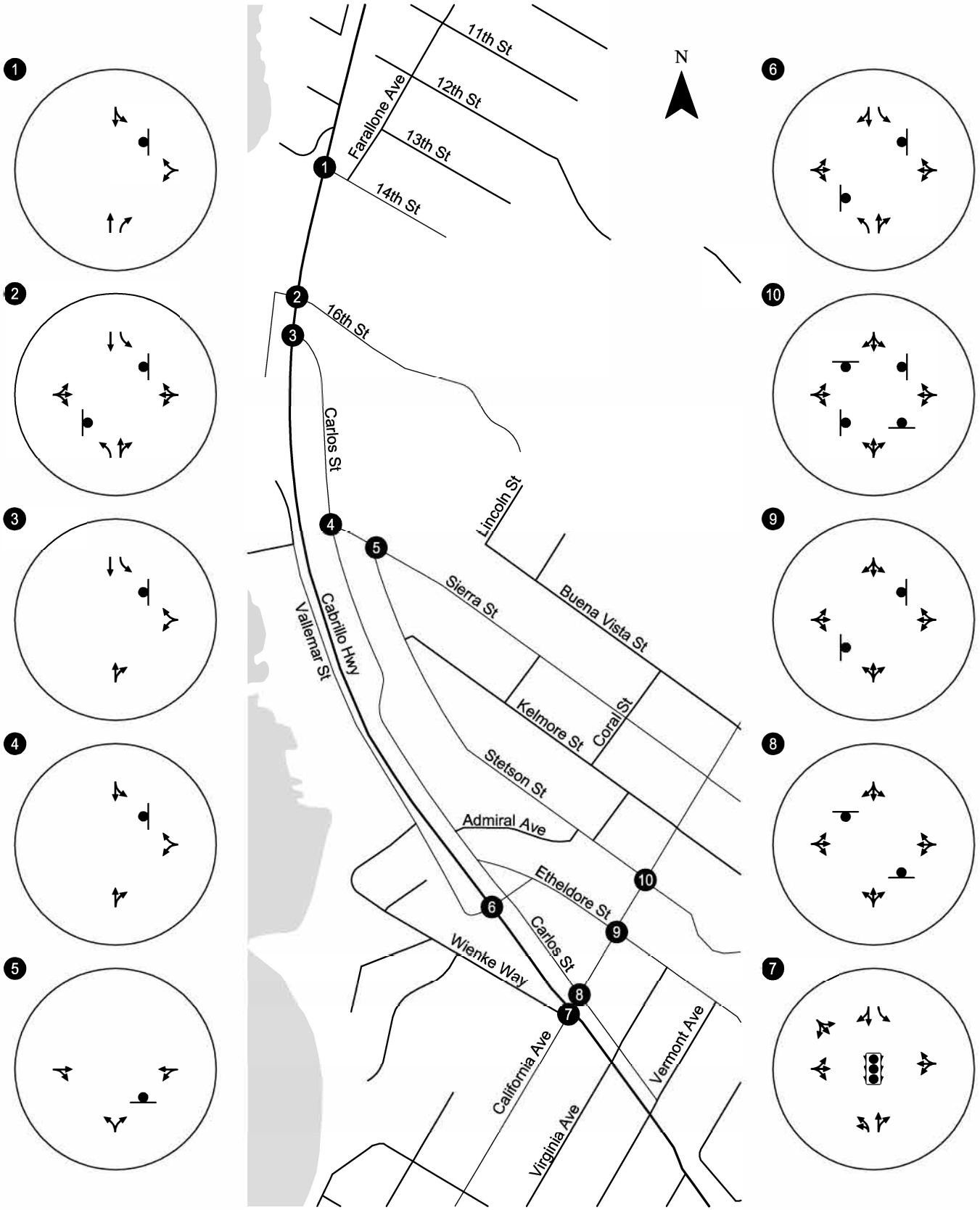
H:\20\20616 - Moss Beach Housing TIA\dwgs\Figs\20616_Fig01_revised_for_report.dwg Jan 10, 2018 - 3:08pm - malston Layout Tab: F10 CUM TCDs



-  - STOP SIGN
-  - TRAFFIC SIGNAL

Cumulative Lane Configurations and Traffic Control Devices Moss Beach, California

Figure 11

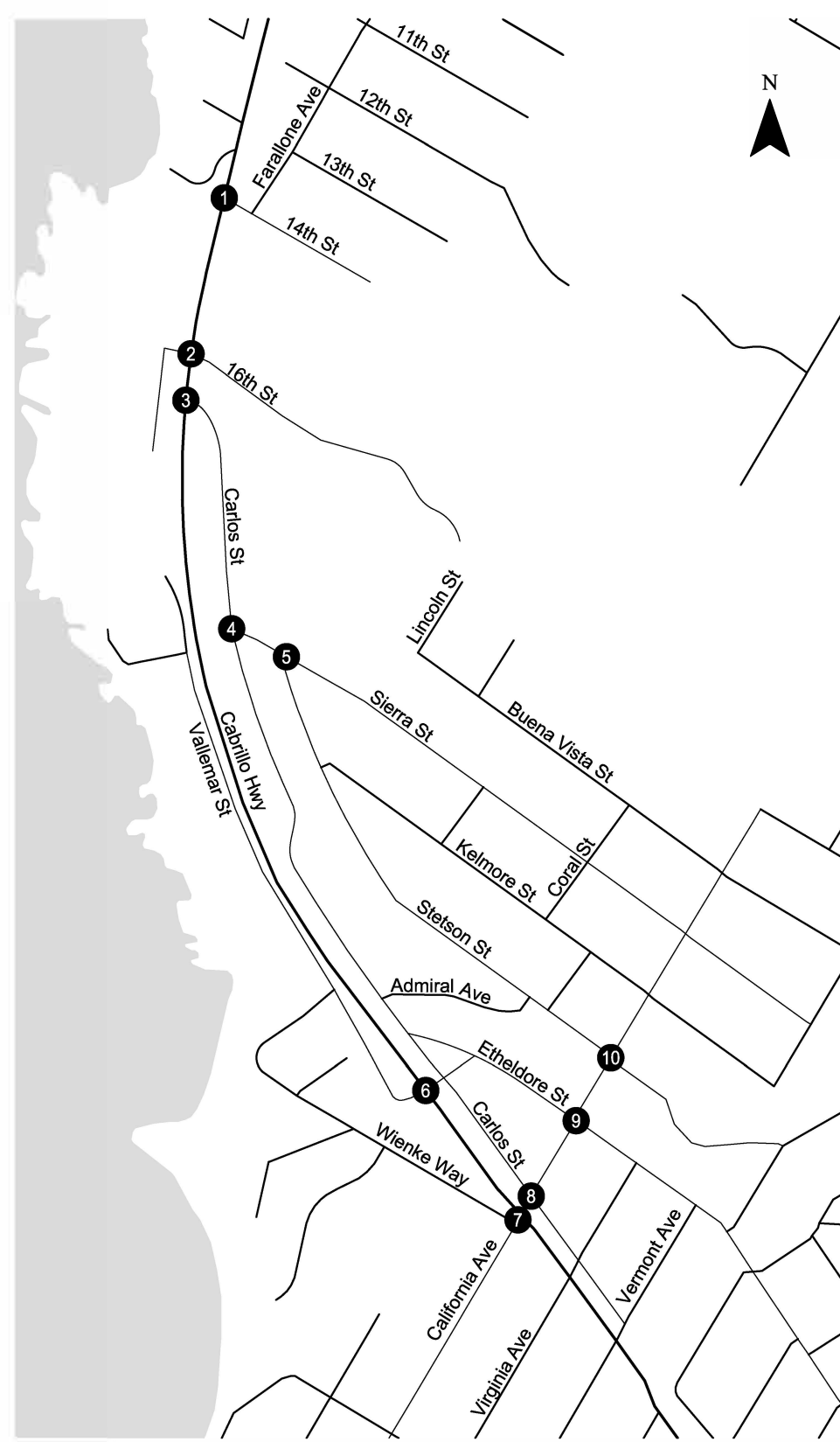

CM = CRITICAL MOVEMENT (UNSIGNALIZED)
 LOS = CRITICAL MOVEMENT LEVEL OF SERVICE (SIGNALIZED)/CRITICAL MOVEMENT LEVEL OF SERVICE (UNSIGNALIZED)
 Del = INTERSECTION AVERAGE CONTROL DELAY (SIGNALIZED)/CRITICAL MOVEMENT CONTROL DELAY (UNSIGNALIZED)
 V/C = CRITICAL CRITICAL VOLUME-TO-CAPACITY RATIO

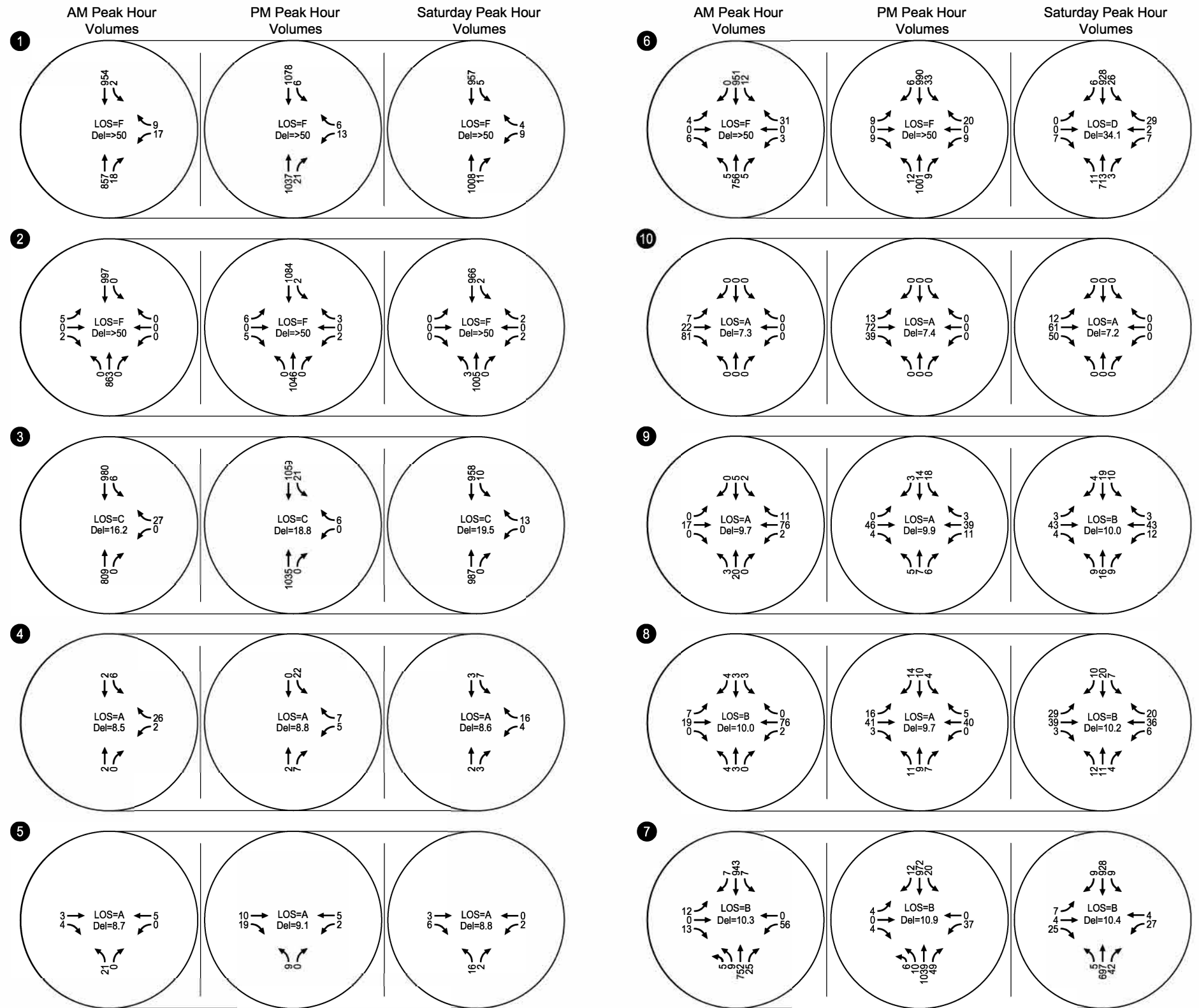

Cumulative Turning Movement Volumes and Operations
 AM, PM, and Saturday Peak Hour
 Moss Beach, California

Figure
 12

Cumulative with Project Conditions

This section discusses the effect of the Project on traffic operations under Cumulative conditions. Traffic volumes for the Cumulative with Project condition were developed using the same additive approach used for the Existing with Project and Background with Project volumes. The turning movement volumes resulting from adding the Project trips to the Cumulative conditions volumes are shown in Figure 13.

Table 13, Table 14, and Table 15 show the Cumulative with Project intersection operations for the AM, PM, and Saturday peak hours, respectively. Detailed calculation worksheets for the Cumulative with Project conditions are provided in Appendix 9. Based on the significance criteria previously described, the Project would cause significant impacts at the following locations:

- **Intersection #2: State Route 1 and 16th Street** – The addition of project trips increases delay for the critical movement at the intersection already exceeding the LOS standard by at least 4 seconds per vehicle during the PM peak hour.
- **Intersection #3: State Route 1 and Carlos Street** – The addition of project trips causes the critical movement at the intersection to degrade below the LOS D standard during the AM, PM, and Saturday peak hours.
- **Intersection #6: State Route 1 and Vallemar Street/Etheldore Street** – The addition of project trips increases delay for the critical movement at the intersection already exceeding the LOS standard to increase by at least 4 seconds per vehicle during the PM and Saturday peak hours. During the Saturday peak, the addition of project trips also causes the LOS to increase to ‘E,’ exceeding the LOS D standard.

Table 13: Cumulative with Project AM Peak Hour Intersection Operations

No	Location	Control	Cumulative AM		Cumulative AM + Project	
			Delay	LOS	Delay	LOS
1	State Route 1 & 14th Street	TWSC	58.2	F	60.6	F
2	State Route 1 & 16th Street	TWSC	74.7	F	77.5	F
3	State Route 1 & Carlos Street	TWSC	16.2	C	36.7	E
4	Carlos Street & Sierra Street	TWSC	8.5	A	8.5	A
5	Stetson Street & Sierra Street	TWSC	8.7	A	8.7	A
6	State Route 1 & Vallemar Street / Etheldore Street	TWSC	52.3	F	53.6	F
7	State Route 1 & California Avenue / Wienke Way	Signal	10.3	B	12.2	B
8	Carlos Street & California Avenue	TWSC	10.0	B	10.0	B
9	Etheldore Street & California Avenue	TWSC	9.7	A	9.7	A
10	Stetson Street & California Avenue	AWSC	7.3	A	7.3	A

Note: **Bold lettering** indicates an intersection that does not meet the County's minimum acceptable design level of service (LOS C, and LOS D for critical movements). **Shaded cells** indicate a significant impact.

AWSC: All-Way Stop Control, TWSC: Two-Way Stop Control. LOS and delay reported for TWSC intersections is for the worst approach or movement; complete intersection operations are provided in Appendix 9.

Source: Highway Capacity Manual 2010; Kittelson & Associates, 2018

Table 14: Cumulative with Project PM Peak Hour Intersection Operations

No	Location	Control	Cumulative PM		Cumulative PM + Project	
			Delay	LOS	Delay	LOS
1	State Route 1 & 14th Street	TWSC	88.6	F	92.5	F
2	State Route 1 & 16th Street	TWSC	105.3	F	114.2	F
3	State Route 1 & Carlos Street	TWSC	18.8	C	64.2	F
4	Carlos Street & Sierra Street	TWSC	8.8	A	8.8	A
5	Stetson Street & Sierra Street	TWSC	9.1	A	9.1	A
6	State Route 1 & Vallemar Street / Etheldore Street	TWSC	106.3	F	112.0	F
7	State Route 1 & California Avenue / Wienke Way	Signal	10.9	B	11.1	B
8	Carlos Street & California Avenue	TWSC	9.7	A	9.7	A
9	Etheldore Street & California Avenue	TWSC	9.9	A	9.9	A
10	Stetson Street & California Avenue	AWSC	7.4	A	7.4	A

Note: **Bold lettering** indicates an intersection that does not meet the County's minimum acceptable design level of service (LOS C, and LOS D for critical movements). **Shaded cells** indicate a significant impact.

AWSC: All-Way Stop Control, TWSC: Two-Way Stop Control. LOS and delay reported for TWSC intersections is for the worst approach or movement; complete intersection operations are provided in Appendix 9.

Source: Highway Capacity Manual 2010; Kittelson & Associates, 2018

Table 15: Cumulative with Project Saturday Peak Hour Intersection Operations

No	Location	Control	Cumulative Saturday		Cumulative Saturday + Project	
			Delay	LOS	Delay	LOS
1	State Route 1 & 14th Street	TWSC	59.8	F	60.6	F
2	State Route 1 & 16th Street	TWSC	59.7	F	61.4	F
3	State Route 1 & Carlos Street	TWSC	19.5	C	49.1	E
4	Carlos Street & Sierra Street	TWSC	8.6	A	8.6	A
5	Stetson Street & Sierra Street	TWSC	8.8	A	8.8	A
6	State Route 1 & Vallemar Street / Etheldore Street	TWSC	34.1	D	35.1	E
7	State Route 1 & California Avenue / Wienke Way	Signal	10.4	B	10.3	B
8	Carlos Street & California Avenue	TWSC	10.2	B	10.2	B
9	Etheldore Street & California Avenue	TWSC	10.0	B	10.0	B
10	Stetson Street & California Avenue	AWSC	7.2	A	7.2	A

Note: **Bold lettering** indicates an intersection that does not meet the County's minimum acceptable design level of service (LOS C, and LOS D for critical movements). **Shaded cells** indicate a significant impact.

AWSC: All-Way Stop Control, TWSC: Two-Way Stop Control. LOS and delay reported for TWSC intersections is for the worst approach or movement; complete intersection operations are provided in Appendix 9.

Source: Highway Capacity Manual 2010; Kittelson & Associates, 2018

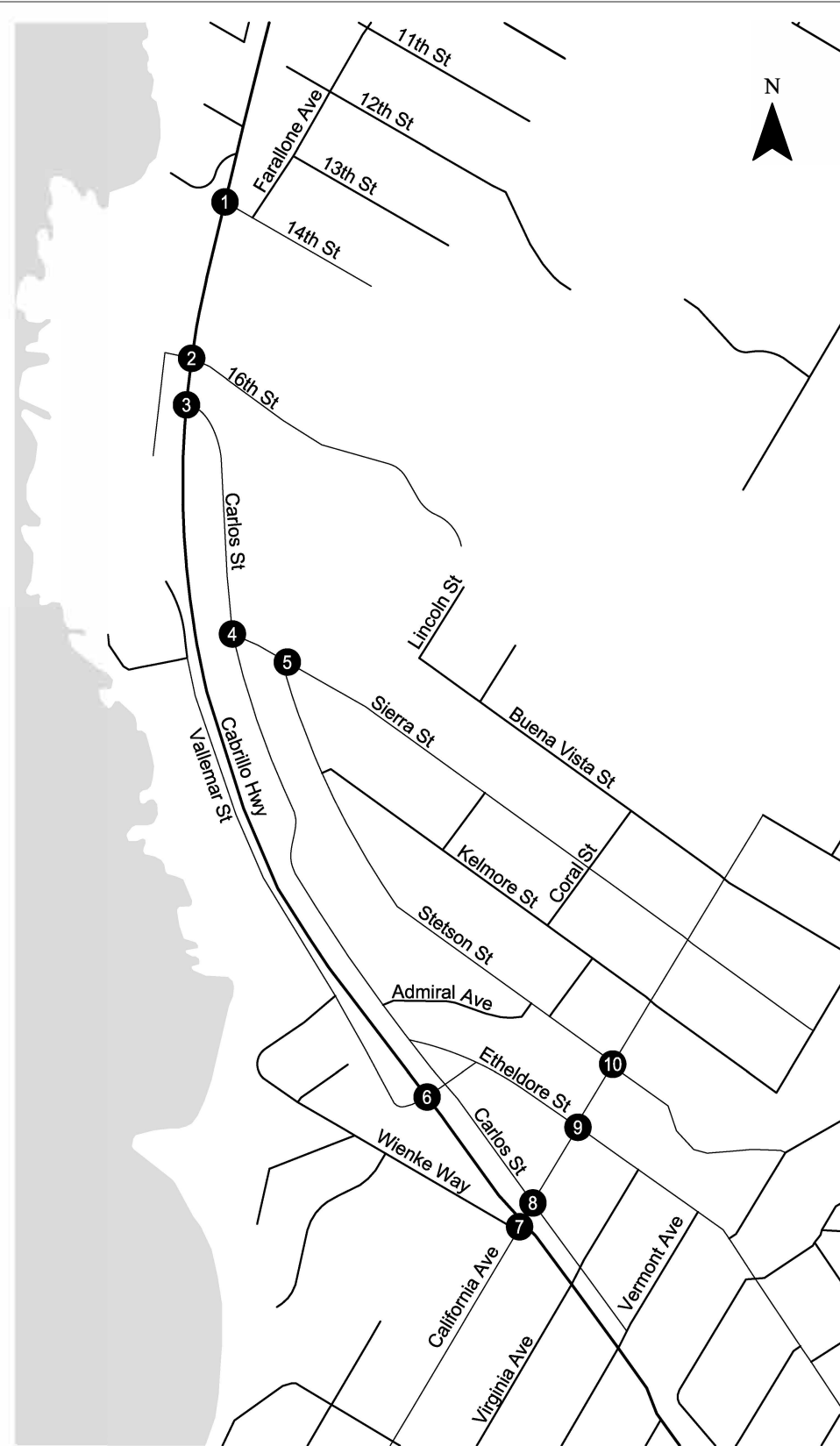

CM = CRITICAL MOVEMENT (UNSIGNALIZED)
 LOS = CRITICAL MOVEMENT LEVEL OF SERVICE (SIGNALIZED)/CRITICAL MOVEMENT LEVEL OF SERVICE (UNSIGNALIZED)
 Del = INTERSECTION AVERAGE CONTROL DELAY (SIGNALIZED)/CRITICAL MOVEMENT CONTROL DELAY (UNSIGNALIZED)
 V/C = CRITICAL CRITICAL VOLUME-TO-CAPACITY RATIO

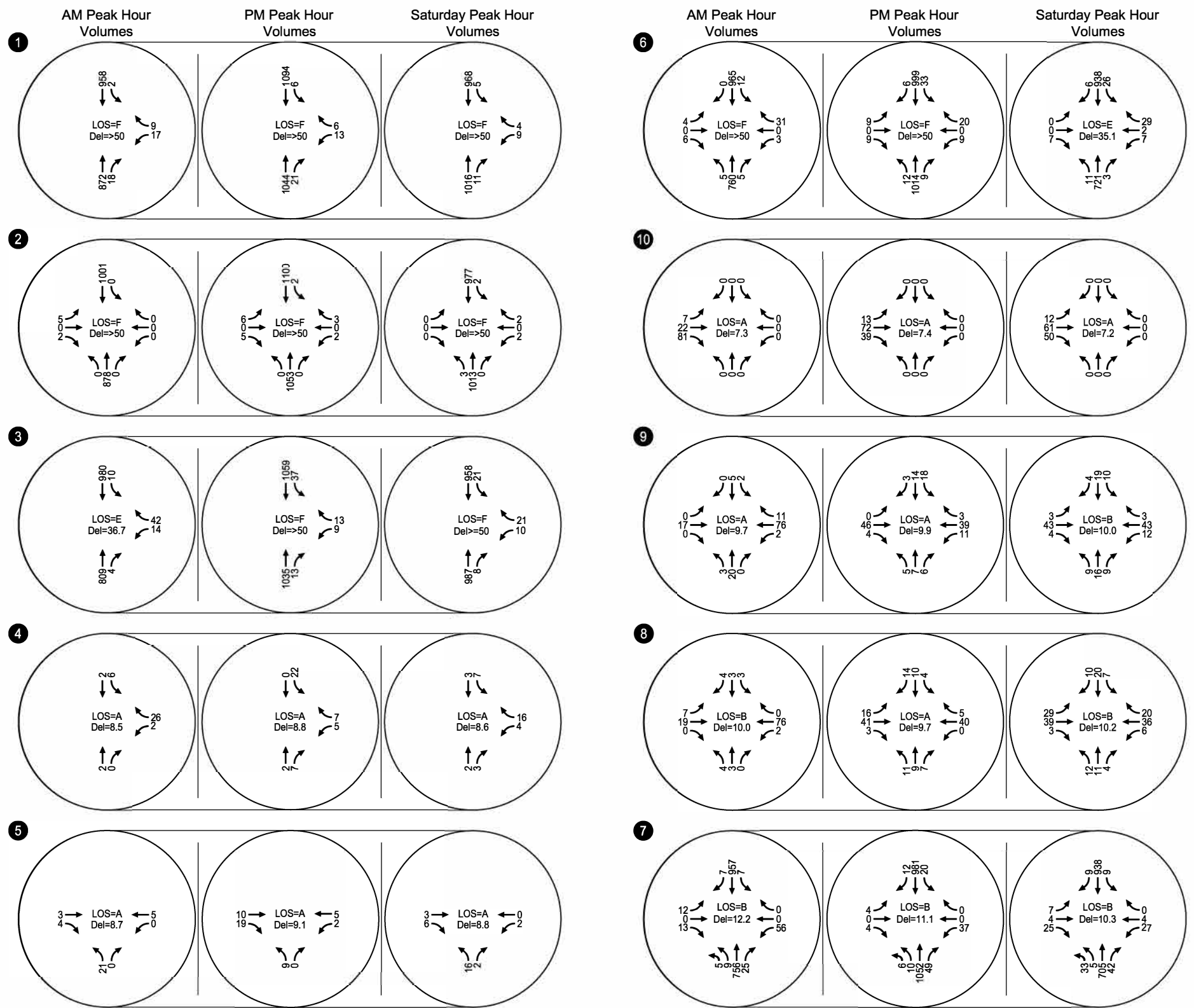

Cumulative with Project Turning Movement Volumes and Operations
 AM, PM, and Saturday Peak Hour
 Moss Beach, California

Figure
 13

DESIGN AND INCOMPATIBLE USE

The conceptual site plan for the Project was reviewed to assess potential hazards due to Project design or operations and potential incompatible land uses. The proposed land uses are generally compatible with existing uses in the Project vicinity and would not result in undue hazards. Therefore, this assessment focuses on potential hazards due to design. The design topic considered was the Project's impact on intersections with restricted sight distance for existing operating speeds per Caltrans *Highway Design Manual* standards.

Kittelsohn reviewed the study intersections that access State Route 1 to determine if any of these have restricted sight distance that does not meet Caltrans standards. The intersection of State Route 1 and Carlos Street was found to provide 305 feet of sight distance to the south, which is 300 feet less than what is required for an intersection with a 55-mph facility such as State Route 1, per Table 405.1A in the Caltrans *Highway Design Manual*.⁸

Additionally, a two-way left turn lane is present along State Route 1 exclusively between Carlos Street and 16th Street. Considering the need for deceleration before making a left turn from State Route 1 to either street, motorists making northbound left turns to 16th Street and those making southbound left turns to Carlos Street represent overlapping and conflicting uses of the lane. The addition of southbound left-turning project traffic from State Route 1 to Carlos Street would further contribute to potential conflict between the two movements.

Because this intersection would serve as the principal means of access for the Project to and from State Route 1, the Project would add traffic to both the movements with restricted sight distance and the overlapping left turns, resulting in a **significant impact** in all Project scenarios.

San Mateo County is currently completing an updated draft of its *Connect the Coasts* study to evaluate transportation needs in the area. County staff have indicated that they will be providing additional analysis and recommendations to address the conditions at the State 1 and Carlos Street intersection. However, at this point in time, the County has not presented recommended improvements or indicated a preferred strategy. Therefore, while Kittelsohn examined three potential mitigation options as part of this report, we are unable to declare any option feasible until the County selects a preferred option and demonstrates a pathway for implementation. For the purposes of further discussion, Kittelsohn provides information on the three mitigation options below:

⁸ Note that the applicable section of State Route 1 has a posted speed limit of 50 miles per hour, which would indicate a design speed of 55 miles per hour, which is the applicable standard for corner sight distance per the Caltrans *Highway Design Manual*.

1. **Closing Carlos Street between State Route 1 and the Project to all but emergency vehicles.** This option was considered because the removal of traffic from this intersection would negate the need for improving intersection sight distance since vehicles would no longer be allowed to enter or exit at this location. Project traffic as well as existing traffic at the intersection would instead be routed south along Carlos Street and Stetson Street to access State Route 1 at either Etheldore Street or California Avenue.

Traffic redistribution associated with this closure was modeled and found to result in a secondary significant impact at the intersection of Etheldore Street and State Route 1 where the critical movement delay increased by 4 seconds or more during the PM peak hour, which would cause it to fall below the LOS 'D' threshold in the AM and Saturday peak hours. Feasible mitigation measures to address this secondary impact could not be found (explained in discussion of Impact TRAF-2 in CEQA Project Impacts and Proposed Mitigations).

2. **Connecting Carlos Street with 16th Street instead of State Route 1.** In field review, 16th Street was found to provide sufficient corner sight distance. This option would reroute Carlos Street at State Route 1 into 16th Street instead, directing all inbound and outbound Carlos Street traffic to 16th Street through a new connection between these two streets. However, this option faces three potential challenges that must be examined further:

- The State Route 1/ 16th Street intersection operates below the County threshold under the Cumulative and Cumulative with Project Conditions. Therefore, routing additional vehicle trips otherwise destined for Carlos Street to 16th Street would further degrade operations at this intersection and may trigger a significant impact at that location.
- A new "Tee" intersection of 16th Street and Carlos Street in close proximity (less than one car length) to the existing stop-controlled intersection between State Route 1 and 16th Street would have the potential to create conflicts between vehicles turning from State Route 1 onto 16th Street and vehicles turning from Carlos Street onto 16th Street, especially given the difference in operating speeds for motorists turning from the highway compared to motorists driving along Carlos Street. In order to avoid conflicts, the County could need to obtain additional right of way to increase the distance between State Route 1 and a potential Carlos Street/16th Street intersection.
- There is a significant grade difference between Carlos Street and 16th Street and providing a formal connection may not be reasonable geometrically. In order to create a reasonable grade for such connection, the County would potentially need to obtain additional right of way.

3. **Grading the east side of State Route 1 to provide clear sight distance.** Given speeds along State Route 1, earthwork or tree clearing would be necessary to clear required sight distance to the south at Carlos Street. This would include cutting back trees and re-grading the berm between Highway 1 and Carlos Street. While clearing the land would provide adequate sight distance for the horizontal curvature of the road (see Figure 1), there is also a vertical curve due to elevation changes that may obstruct sight distance. Because Highway 1 crests south of the Carlos Street intersection, a driver may

not be able to see vehicles on the other side of the crest of the curve. A detailed topographic map would be needed to determine if horizontal clearing, which may be prohibitively expensive and would require an encroachment permit from Caltrans, would provide adequate sight distance given the vertical curve.

EMERGENCY ACCESS

Primary access to the Project would be provided by the driveway on Carlos Street. Additionally, there is an emergency vehicle access route provided from Lincoln Street. Given the two access points available for emergency vehicle ingress and egress, the Project's proposed site plan is expected to provide adequate emergency vehicle access. This analysis assumes, in accordance with CEQA, that the final design of all circulation improvements shall be required to adhere to all applicable County and other statutes and requirements, including, without limitation, those set forth in the California Fire Code and California Vehicle Code. Therefore, the impact is considered to be **less than significant**.

TRANSIT IMPACTS

The Project site is served by two bus routes (Route 17 and Route 18) operated by SamTrans transit service (see Figure 4). The nearest Route 17 bus stops are at the following locations:

- Northbound: North of the Project on the east side of State Route 1 at State Route 1 / 14th Street (0.23 miles from the Project).
- Southbound weekday AM: South of the Project at Etheldore Street / Sunshine Valley Road (0.62 miles from the Project).
- Southbound weekday PM and weekend: North of the Project on the west side of State Route 1 between Carlos Street and 16th Street (0.11 miles from the Project) and at California Avenue / Etheldore Street (0.47 miles from the Project).

The nearest Route 18 bus stops in both directions are at Sunshine Valley Road / Etheldore Street (0.47 miles from the Project).

Both of these routes primarily travel along State Route 1. Since the majority of State Route 1 traffic movements experience little or no delay, the Project traffic is not anticipated to decrease the performance of public transit.

BICYCLE IMPACTS

A qualitative assessment was conducted to determine the Project's potential impacts on bicyclists and bicycle facilities. San Mateo County's Bicycle and Pedestrian Master Plan (2011) includes planned Class I, Class II and Class III bikeways in the vicinity of the Project. These facilities include:

- Class I multi-use path near State Route 1 between Carlos Street and Main Street
- Class II bicycle lane along Carlos Street

- Class III bicycle route along State Route 1

The Project does not conflict with existing or proposed bicycle facilities identified in the Bicycle and Pedestrian Master Plan because the Project is not proposing to change roadway geometries in ways which would prevent the development of the proposed bicycle facilities. Therefore, the impact is considered to be **less than significant**.

PEDESTRIAN IMPACTS

A qualitative assessment was conducted to determine the Project's potential impacts on pedestrians and pedestrian facilities. Based on this assessment, the project would result in the following potentially significant impacts on the performance or safety of pedestrian facilities:

Pedestrian Access to Transit – The Project may lead to an increase in pedestrians accessing the nearest bus stop which is located across State Route 1 near Carlos Street (see *Transit Impacts* for more information on the local transit network). This stop serves Route 17 for the weekday PM and weekend service but there is no marked crosswalk across State Route 1 to access it. Additionally, there is inadequate corner sight distance at the intersection of Carlos Street and State Route 1 for pedestrians to see vehicles and drivers to see pedestrians.

The draft *Connect the Coastside* study, which was prepared by San Mateo County to evaluate transportation needs in this area, has proposed a striped pedestrian crossing with a beacon along State Route 1 at 16th Street in the vicinity of the southbound bus stop based on established needs.⁹ The published report is a draft, and final recommendations have not yet been developed. Additionally, there has not been a detailed design study for this crossing to determine if it is feasible given the inadequate sight distance.

Since the Project will likely increase the pedestrian demand for crossing State Route 1 at an unmarked crossing location with inadequate sight distance, the Project will increase the hazard for this crossing, resulting in a **significant impact**.

Pedestrian Access to Sidewalk Network – The proposed access driveway for the Project is on Carlos Street, which does not provide pedestrian facilities such as sidewalks to connect the Project to sidewalks on the north side of Sierra Street and the east side of Stetson Street. Since the Project is anticipated to house more than 200 residents, it is likely to increase pedestrian activity in the area. Without a proper connection to the sidewalks on Sierra Street and Stetson Street, Project residents would need to walk in

⁹ *Connect the Coastside* Draft Report, March 2016. Available online at <https://planning.smcgov.org/sites/planning.smcgov.org/files/press-release/files/1.3%20CTMP%20Draft%20Recommendation%20of%20Transportation%20Improvements%20and%20Appendices%204.13.16.pdf>

the street, resulting in the potential for decreased pedestrian safety. Therefore, the impact is considered to be a **significant impact**.

CEQA PROJECT IMPACTS AND PROPOSED MITIGATIONS

TRAF-1 **The proposed project would conflict with an applicable plan, ordinance, or policy establishing measures of effectiveness for the performance of the intersections under Existing Conditions. This is considered to be a potentially significant impact.**

The Project's potentially significant impacts to intersection operations were identified using the criteria previously described in this report. Based on these criteria, the following intersections were found to be operating below the LOS standard under Existing Conditions.

Impact TRAF-1A: The additional traffic generated by the Project would result in an increase in delay for the critical movement at the intersection of **State Route 1 and California Avenue/Wienke Way (#7)**, which is already operating below the LOS standard, by at least 4 seconds during the PM and Saturday peak hours under Existing Conditions.

As one of the main access points to the neighborhood in which the Project is located, the additional traffic at this intersection caused by the Project represents about a 1.4% increase in intersection demand. This will increase the delay by at least four seconds for vehicles waiting to make the westbound left turn from California Avenue to southbound State Route 1. The addition of this traffic would result in the delay for the westbound left turn increasing by 5.9 seconds per vehicle during the PM peak hour and 5.2 seconds per vehicle during the Saturday peak hour. To reduce this impact, the following mitigation measures are proposed.

Mitigation Measure TRAF-1A – San Mateo County will work with Caltrans to convert the intersection control from two-way stop control into a roundabout or signalized intersection. The exact intersection control will be determined at the conclusion of an Intersection Control Evaluation (ICE) study as required by Caltrans. The ICE study would be performed as part of the design phase for changing the intersection control.

The intersection was modeled as a five-leg signalized intersection to assess the mitigation measure. Conversion to a five-leg signalized intersection would improve the operation of this intersection to LOS 'A' during the PM peak hour and LOS 'B' during the Saturday peak hour with critical movements operating within County LOS standards, lessening the Project impacts to less than significant (Table 16 and Appendix 10). A preliminary analysis was also performed for a single-lane roundabout alternative, which was found to meet the current LOS standard for the County under Cumulative conditions (see Appendix 11). To be consistent with the draft *Connect the Coastside* recommendations, the signal control alternative was modeled to represent the ability of Mitigation Measure TRAF-1A to mitigate the impact fully. A more detailed analysis will be performed as part of an ICE during the design phase to select whether a roundabout or signal is preferred.

Although this mitigation measure with conversion to a signalized intersection would reduce this impact to a less-than-significant level, this intersection is under the jurisdiction of Caltrans. Thus, San Mateo County would need to obtain an encroachment permit from Caltrans. With the implementation and

timing of the mitigation measure not entirely under the County's control and therefore uncertain, this impact would be significant and unavoidable.

Mitigation Measure TRAF-1B – Develop a Transportation Demand Management (TDM) plan for review and approval by San Mateo County which may include:

- Local live-work preference for residents
- One or more dedicated car share parking space(s)
- Free or discounted SamTrans transit passes
- Provide public transit information and education for residents – maps and schedules for residents, brochures about environmental and health benefits
- Provide a pedestrian trunk (grocery cart) to eliminate driving to local market
- Provide both short and long-term secure bicycle parking
- Support for active transportation through provision of bicycle and pedestrian-supportive infrastructure, streets, etc. within the Project
- Additional measures that may become available as technology evolves

Implementation of a TDM plan may reduce the number of vehicle trips generated by the Project and reduce the impact to the transportation infrastructure. Although a TDM plan may reduce the vehicle trip generation and lessen the impact, the effectiveness of a TDM plan cannot be guaranteed. Therefore, the impact remains significant and unavoidable.

Significance After Mitigation: Significant and unavoidable.

Table 16: Existing Conditions Intersection Operations at State Route 1 & California Avenue / Wienke Way

#	Location	Control	Peak Hour	Existing		Existing + Project		Existing + Project, Mitigated (Signal)	
				Delay	LOS	Delay	LOS	Delay	LOS
7	State Route 1 & California Avenue / Wienke Way	TWSC (Signal in Mitigated Condition)	AM	43.5	E	45.6	E	9.9	A
			PM	78.2	F	84.1	F	8.5	A
			Sat.	87.1	F	92.3	F	11.1	B

Note: Bold lettering indicates an intersection that does not meet the County's minimum acceptable design level of service (LOS C, and LOS D for critical movements). Shaded cells represent a significant impact.

TWSC: Two-Way Stop Control. LOS and delay reported for TWSC intersections is for the worst approach or movement; complete intersection operations are provided in Appendix 4, Appendix 5, and Appendix 10.

Source: Highway Capacity Manual 2010; Kittelson & Associates, 2018

TRAF-2 **The proposed project would conflict with an applicable plan, ordinance, or policy establishing measures of effectiveness for the performance of the intersections under Background Conditions. This is considered to be a potentially significant impact.**

The Project's potentially significant impacts to intersection operations were identified using the criteria previously described in this report. Based on these criteria, the following intersections were found to be operating below the LOS standard under Background with Project Conditions.

Impact TRAF-2A: The additional traffic generated by the Project would increase delay for the critical movement at the intersection of **State Route 1 and California Avenue/Wienke Way (#7)**, which is already operating below the LOS standard, by at least 4 seconds during the PM and Saturday peak hours under Background with Project conditions.

As one of the main access points to the neighborhood in which the Project is located, the additional traffic at this intersection caused by the Project represents about a 1.3% increase in intersection demand. This will increase the delay by at least four seconds for vehicles waiting to make the westbound left turn from California Avenue to southbound State Route 1. The addition of this traffic results in the westbound left turn delay increasing by 11.6 seconds per vehicle during the PM peak hour and 6.3 seconds per vehicle during the Saturday peak hour. To reduce this impact, implement the following mitigation measures.

Mitigation Measures: Implement Mitigation Measures **TRAF-1A** and **TRAF-1B**.

Implementation of Mitigation Measures **TRAF-1A** and **TRAF-1B** would improve the operation of this intersection to LOS 'A' during the PM peak hour and LOS 'B' during the Saturday peak hour with critical movements operating within County LOS standards, lessening the Project impacts to less than significant (Table 17 and Appendix 12). Although this mitigation measure would reduce this impact to a less-than-significant level, this intersection is under the jurisdiction of Caltrans. Thus, San Mateo County will need to obtain an encroachment permit from Caltrans. With the implementation and timing of the mitigation measure not entirely under the County's control and therefore uncertain, this impact would be significant and unavoidable.

Implementation of a TDM plan may reduce the number of vehicle trips generated by the Project and reduce the impact to the transportation infrastructure. Although a TDM plan may reduce the vehicle trip generation and lessen the impact, the effectiveness of a TDM plan cannot be guaranteed. Therefore, the impact remains significant and unavoidable.

Significance After Mitigation: Significant and unavoidable.

Table 17: Background Conditions Intersection Operations at State Route 1 & California Avenue / Wienke Way

#	Location	Control	Peak Hour	Background		Background + Project		Background + Project, Mitigated	
				Delay	LOS	Delay	LOS	Delay	LOS
7	State Route 1 & California Avenue / Wienke Way	TWSC (Signal in Mitigated Condition)	AM	47.4	E	49.9	E	9.9	A
			PM	112.6	F	124.2	F	9.7	A
			Sat.	96.1	F	102.4	F	11.6	B

Note: Bold lettering indicates an intersection that does not meet the County's minimum acceptable design level of service. (LOS C, and LOS D for critical movements). Shaded cells represent a significant impact.

TWSC: Two-Way Stop Control. LOS and delay reported for TWSC intersections is for the worst approach or movement; complete intersection operations are provided in Appendix 6, Appendix 7, and Appendix 12.

Source: Highway Capacity Manual 2010; Kittelson & Associates, 2018

Impact TRAF-2B: The Project would cause the critical movement of **State Route 1 and Carlos Street (#3)** to operate below the LOS D standard under Background with Project Conditions during the Saturday peak hour.

This intersection would serve as the main access point to the Project from State Route 1. The addition of Project traffic to the westbound approach at this intersection would increase the average delay for vehicles waiting to turn onto State Route 1, causing the westbound approach to change from LOS C to LOS E.

Mitigation Measures: Implement Mitigation Measure TRAF-1B

Although three additional potential mitigation options were considered, they cannot be considered feasible until San Mateo County selects a preferred approach.

- 1. Closing Carlos Street between State Route 1 and the Project to all but emergency vehicles.** This option was considered because the removal of traffic from this intersection would negate the need for improving intersection sight distance since vehicles would no longer be allowed to exit at this location. Project traffic as well as existing traffic at the intersection would instead be routed south along Carlos Street and Stetson Street to access State Route 1 at either Etheldore Street or California Avenue.

Traffic redistribution associated with this closure was modeled and found to result in a secondary significant impact at the intersection of Etheldore Street and State Route 1 where the critical

movement delay increased by 4 seconds or more during the PM peak hour and would fall below the LOS 'D' threshold in the AM and Saturday peak hours. Feasible mitigation measures to address this secondary impact could not be found (explained in discussion of Impact TRAF-2 in CEQA Project Impacts and Proposed Mitigations).

2. Connecting Carlos Street with 16th Street instead of State Route 1. In field review, 16th Street was found to provide sufficient corner sight distance. This option would reroute Carlos Street at State Route 1 into 16th Street instead, directing all inbound and outbound Carlos Street traffic to 16th Street. However, this option was considered infeasible for the following reasons:

- State Route 1 & 16th Street operates below the County threshold in Cumulative and Cumulative with Project Conditions. Therefore, routing additional vehicle trips otherwise destined for Carlos Street to 16th Street would further degrade operations at this intersection and could trigger a significant impact at that location.
- A "Tee" intersection of 16th Street and Carlos Street in close proximity (less than one car length) to the existing stop-controlled intersection between State Route 1 and 16th Street would have the potential to create conflicts between vehicles turning from State Route 1 onto 16th Street and vehicles turning from Carlos Street onto 16th Street, especially given a difference in operating speeds for motorists turning from the highway compared to motorists driving along Carlos Street. In order to avoid conflicts, the County could need to obtain additional right of way to increase the distance between State Route 1 and a potential Carlos Street/16th Street intersection.
- There is a significant grade difference between Carlos Street and 16th Street and providing a formal connection may not be reasonable geometrically. In order to create a reasonable grade for such connection, the County would potentially need to obtain additional right of way.

3. Grading the east side of State Route 1 to provide clear sight distance. Given speeds along State Route 1, earthwork or tree clearing would be necessary to clear required sight distance to the south at Carlos Street. This would include cutting back trees and re-grading the berm between Highway 1 and Carlos Street. While clearing the land would provide adequate sight distance for the horizontal curvature of the road (see Figure 1), there is also a vertical curve due to elevation changes that may obstruct sight distance. Because Highway 1 crests south of the Carlos Street intersection, a driver may not be able to see vehicles on the other side of the crest of the curve. A detailed topographic map would be needed to determine if horizontal clearing, which may be prohibitively expensive and would require an encroachment permit from Caltrans, would provide adequate sight distance given the vertical curve.

Implementation of a TDM plan may reduce the number of vehicle trips generated by the Project and reduce the impact to the transportation infrastructure. Although a TDM plan may reduce the vehicle trip generation and lessen the impact, the effectiveness of a TDM plan cannot be guaranteed. Additionally, County staff have indicated that they will be providing additional analysis and recommendations in the updated *Connect the Coasts* report. However, the County has not presented a recommended mitigation or indicated a clear pathway for implementing potential improvements. As a result, we cannot consider any option feasible at this point in time.

Therefore, the impact remains significant and unavoidable.

Significance After Mitigation: Significant and unavoidable.

TRAF-3 **The proposed project would conflict with an applicable plan, ordinance, or policy establishing measures of effectiveness for the performance of the intersections under Cumulative Conditions. This is considered to be a potentially significant impact.**

The Project's potentially significant impacts to intersection operations were identified using the criteria previously described in this report. Based on these criteria, the following significant impacts were found for Cumulative with Project Conditions.

Impact TRAF-3A: The additional traffic generated by the Project would result in the critical movement of **State Route 1 and Carlos Street (#3)** operating below the LOS D standard under Cumulative Conditions during the AM, PM, and Saturday peak hours.

This intersection serves as the main access point to the Project from State Route 1. The addition of Project traffic to the westbound approach at this intersection increases the average delay for vehicles waiting to turn onto State Route 1 causing the westbound approach to change from LOS C to LOS E during the AM peak hour and LOS C to LOS F during the PM and Saturday peak hours. To reduce this impact, implement the following mitigation measures.

Mitigation Measure: Implement Mitigation Measure **TRAF-1B**.

Three additional potential mitigations were considered but not advanced because they were considered infeasible (see discussion of Impact **TRAF-2B**). Implementation of a TDM plan may reduce the number of vehicle trips generated by the Project and reduce the impact to the transportation infrastructure. Although a TDM plan may reduce the vehicle trip generation and lessen the impact, the effectiveness of a TDM plan cannot be guaranteed. Therefore, the impact remains significant and unavoidable.

Significance After Mitigation: Significant and unavoidable.

Impact TRAF-3B: The additional traffic generated by the Project would result in delay of the critical movement at the intersection of **State Route 1 and Vallemar Street / Etheldore Street (#6)**, which is already operating below the LOS standard, to increase by at least 4 seconds during the Saturday peak

hour (5.7 seconds) under Cumulative with Project conditions. To reduce this impact, implement the following mitigation measures.¹⁰

Mitigation Measure TRAF-3B – Implement Mitigation Measure TRAF-1B.

Implementation of a TDM plan (TRAF-1B) may reduce the number of vehicle trips generated by the Project and reduce the impact to the transportation infrastructure. Although a TDM plan could reduce the vehicle trip generation and lessen the impact, the effectiveness of a TDM plan cannot be guaranteed. Therefore, the impact remains significant and unavoidable.

Additional mitigation measures were considered including signalization, left turn restrictions, and the addition of left turn lanes. However, these options were determined to not be feasible for the following reasons:

- Signalization – The intersection of Etheldore Street and State Route 1 does not meet the peak hour signal warrant (Appendix 13), therefore, signalization is not warranted.
- Left Turn Restrictions – restricting the eastbound and westbound left turns out of Etheldore Street and State Route 1 during the peak periods and reassigning them to the intersection of California Avenue/Wienke Way and State Route 1 would reduce the impact to less than significant. However, Caltrans has indicated that they would not allow this type of restriction making this option infeasible.
- Additional Turn Lanes – Adding exclusive left turn lanes on the eastbound and westbound approaches at the intersection would separate the left and right turning traffic reducing queues and delay. However, separating the left and through/right lanes was not sufficient to mitigate the impact since the left turn lanes still have a delay that is at least 4 seconds higher than in the No Project conditions. Since the intersection delay is still impacted, the additional lanes would not mitigate the impact.

Significant After Mitigation: Significant and unavoidable.

Impact TRAF-3C: The additional traffic generated by the Project would result in delay of the critical movement at the intersection of **State Route 1 and 16th Street (#2)**, which is already operating below the

¹⁰ Note that the draft *Connect the Coastside* study recommends maintaining intersection level of service standards only for signalized intersections or for unsignalized intersections that meet a peak-hour signal warrant. If this change is made by the County upon completing of the study, this intersection would not represent an impact.

LOS standard, to increase by at least 4 seconds during the PM peak hour (8.9 seconds) under Cumulative with Project conditions.¹¹ To reduce this impact, implement the following mitigation measures.

Mitigation Measure: Implement Mitigation Measure **TRAF-1B**.

Implementation of a TDM plan (TRAF-1B) may reduce the number of vehicle trips generated by the Project and reduce the impact to the transportation infrastructure. Although a TDM plan could reduce the vehicle trip generation and lessen the impact, the effectiveness of a TDM plan cannot be guaranteed. Therefore, the impact remains significant and unavoidable.

Additional mitigation measures were considered including signalization, left turn restrictions, and the addition of left turn lanes. However, these options were determined to not be feasible for the following reasons:

- Signalization – The intersection of 16th Street and State Route 1 does not meet the peak hour signal warrant (Appendix 13), therefore, signalization is not warranted.
- Left Turn Restrictions – restricting the westbound left turn out of 16th Street and State Route 1 during the peak periods and reassigning them to the right turn movement would reduce the impact to less than significant. However, Caltrans has indicated that they would not allow this type of restriction making this option infeasible.
- Additional Turn Lanes – Adding exclusive left turn lane on westbound approach at the intersection would separate the left and right turning traffic reducing queues and delay. However, separating the left and through/right lanes was not sufficient to mitigate the impact since the left turn lanes still have a delay that is at least 4 seconds higher than the no project conditions. Since the intersection delay is still impacted, the additional lanes would not mitigate the impact.

Significant After Mitigation: Significant and unavoidable.

¹¹ Note that the draft *Connect the Coastside* study recommends maintaining intersection level of service standards only for signalized intersections or for unsignalized intersections that meet a peak-hour signal warrant. If this change is made by the County upon completing of the study, this intersection would not represent an impact.

TRAF-4 The proposed project would substantially increase hazards due to a design feature (e.g., sharp curves or dangerous intersections) or incompatible uses (e.g., farm equipment).

The conceptual site plan for the Project was reviewed to assess potential hazards due to Project design and potentially incompatible uses. The proposed land uses are generally compatible with existing uses in the Project area and would not result in undue hazards. Therefore, this assessment focuses on potential hazards due to design by examining whether the Project would increase the level of traffic for movements that have restricted sight distance based on existing operating speeds per Caltrans *Highway Design Manual* standards.

Impact TRAF-4A: The Project would add traffic to the westbound approach to the intersection of Carlos Street and State Route 1, which has inadequate sight distance for seeing northbound vehicles on State Route 1. It would also cause potential conflict between Project trips making a southbound left onto Carlos Street and non-Project traffic making a northbound left into the Lighthouse since both movements share a very short left turn lane. This would cause a significant impact under all with Project scenarios.

This intersection provides primary access to the Project site from State Route 1. Project vehicles would have restricted sight distance when exiting onto State Route 1 making it difficult to judge adequate gap acceptance for safe entry onto State Route 1. To reduce this impact, implement the following mitigation measures.

Mitigation Measure: Implement Mitigation Measure TRAF-1B.

Three additional potential mitigations were considered but not advanced because they were considered infeasible (see discussion of Impact **TRAF-2B**). Implementation of a TDM plan may reduce the number of vehicle trips generated by the Project and reduce the impact to the transportation infrastructure. Although a TDM plan may reduce the vehicle trip generation and lessen the impact, the effectiveness of a TDM plan cannot be guaranteed. Therefore, the impact remains significant and unavoidable.

Significance After Mitigation: Significant and unavoidable.

TRAF-5	The additional traffic associated with the proposed project has the potential to decrease the performance or safety of public transit, bicycle, or pedestrian facilities. This would be considered a potentially significant impact.
---------------	---

The Project's potentially significant impacts on transit, bicycle, and pedestrian facility performance and safety were assessed using both qualitative and quantitative measures.

Impact TRAF-5A: The increase in pedestrian activity expected as a result of the Project generate more pedestrian activity on Carlos Street and an increased potential for pedestrian/vehicle interactions because there are currently no sidewalks along the Project's frontage. To reduce this impact, implement the following mitigation measure.

Mitigation Measure TRAF-5A – Construct a sidewalk that connects the Project entrance on Carlos Street to the sidewalk located on the north side of Sierra Street. This includes land both on and adjacent to the Project property.

Implementation of Mitigation Measure TRAF-5A would separate pedestrians from motor vehicles reducing the potential for pedestrian/vehicle interactions. After implementation, this impact will be less than significant.

Significance After Mitigation: Less than significant.

Impact TRAF-5B: The increase in transit ridership expected as a result of the Project may lead to more pedestrians crossing State Route 1 to access the bus stop on southbound State Route 1 at 16th Street. This may increase the potential risk for pedestrian/vehicle interactions on State Route 1 given that there are currently no marked pedestrian crossings across State Route 1 near Carlos Street to access this stop. Additionally, the limited sight distance at this location would not allow sufficient visibility for pedestrians to be seen by vehicles on State Route 1. To reduce this impact, implement the following mitigation measures.

Mitigation Measure TRAF-5B – The project sponsor should distribute informational literature to tenants upon move-in detailing available transit service and bus stop locations. The informational literature should discourage the use of the southbound bus stop at Carlos Street and State Route 1 because of the inadequate corner sight distance provided at the intersection. Residents should be redirected to use the bus stop at Etheldore Street and California Street instead which is approximately a ten-minute walk from the project entrance.

With implementation of Mitigation Measure TRAF-5B, Project residents would be directed away from a crossing at State Route 1 where there is inadequate sight distance to a bus stop with increased accessibility located approximately 10 minutes from the project entrance via Carlos Street, Sierra Street, Stetson Street, and California Avenue. Implementation of TRAF-5B would also promote transit usage among Project residents by providing information on available transit in the area.

However, the effectiveness of this mitigation in deterring residents from crossing State Route 1 cannot be guaranteed. Therefore, this impact would remain significant and unavoidable.

Significance After Mitigation: Significant and unavoidable.

PARKING ASSESSMENT

Kittelson has provided a parking assessment for informational purposes. This parking assessment reviews the estimated demand for parking based on land use as well as parking requirements stipulated in the San Mateo County Zoning Regulations.¹² Based on the proposed site plan, the Project will provide 142 parking spaces. This section evaluates the adequacy of parking for the Project using two methods. It is first evaluated against San Mateo County zoning regulations on parking. It is also evaluated against parking demand, as estimated based on industry standards.

County Parking Requirements

Based on County zoning regulations, a 71-unit apartment complex is required to have 127 parking spaces as shown in Table 18. Therefore, the Project provides 15 more parking spaces than required by San Mateo County.

Table 18: Parking Requirements for the Project

Apartment Type	Number of Units	Parking Rate (Per Unit)	Parking Required
1 Bedroom	16	1.2	20
2 Bedroom	37	1.5	56
3 Bedroom	18	2	36
Guest Parking ¹		0.2	15
Total:			127
Source: Kittelson & Associates, Inc. 2018 San Mateo County Zoning Regulations Chapter 3, Section 6119 ¹ Guest parking at 1 space per 5 units			

Estimated Parking Demand

An estimate of parking demand was performed using the *Parking Generation Manual* (4th edition) published by the Institute of Transportation Engineers (ITE). This manual is a standard transportation industry document that estimates the demand for parking based on studies conducted at similar sites.

¹² San Mateo County Zoning Regulations, Chapter 3, Section 6119 (December 2012)

The land use in the ITE manual that is the most similar with the Project is the Low/Mid-Rise Apartment (LU 221) since the Apartment (LU 220) is not available.

Based on the demand rates from previous studies compiled in the ITE Manual, the average demand for a 71 unit apartment complex would be about 88 parking spaces while the maximum observed demand would be about 138 parking spaces, as shown in Table 19. This demand includes demand from any guests as well as residents. With a parking supply of 142 spaces, the Project is anticipated to have about 4 more parking spaces than anticipated maximum demand.

Using both criteria, the amount of parking contained in the Project is adequate to meet the demand.

Table 19: Average Estimated Parking Demand for the Project

Parking Demand	Number of Units	Demand Rate ¹	Parking Spaces Needed
Average	71	1.23	88
Maximum Observed		1.94	138
Source: Kittelson & Associates, Inc. Demand based on ITE Parking Generation Manual, 4th Edition (LU 221) ¹ Demand rate in vehicles per apartment			

STATE ROUTE 92 TRAFFIC VOLUMES

Using the C/CAG-VTA San Mateo County Travel Demand Model, Kittelson analyzed AM and PM peak hour traffic flows to and from the Project's traffic analysis zone (TAZ) to estimate project contributions to traffic volumes along State Route 92. The model generates traffic based on assumed land uses within Traffic Analysis Zones (TAZs). Each TAZ is relatively large, so the TAZ containing the project site also includes surrounding areas. As shown in Table 23, information from the model regarding the total number of trips generated by the TAZ that contains the project site, and the number that use SR 92 was used to calculate the percentage of TAZ-generated trips that use SR 92. This percentage was then applied to the trips generated by the Project to estimate trips from the project utilizing SR 92.

Table 20: Project Area Trips on State Route 92

Time Period	Direction	TAZ Volume along SR92	TAZ Total Volume	Percent of TAZ Volume	Total Project Trips	Project Trips Projected on SR92
AM Peak Hour	Inbound	75	490	15%	8	1
	Outbound	111	539	21%	29	6
PM Peak Hour	Inbound	111	539	21%	29	6
	Outbound	75	490	15%	16	2

Source: Kittelson & Associates, Inc.

The Project is projected to generate six eastbound (outbound) and one westbound (inbound) trip along SR 92 in the AM peak hour. In the PM peak hour, the Project is projected to generate two northbound (outbound) and six southbound (inbound) trips in the PM peak hour. These numbers represent a very small fraction of overall traffic on State Route 92, roughly 2,400 during the peak hour (based on Caltrans traffic volumes during 2016).

As part of the resident selection process, the Project proposes to include a preference for individuals who live and/or work in the region. This preference structure increases chances for individuals who meet these criteria to live in this development, although it does not restrict individuals who do not live and/work in the area from being accepted. Based on most recent available data from the U.S. Census Bureau, there are 11,258 jobs located in the Midcoast region (Princeton, Miramar, El Granada, Montara, and Moss Beach) and the neighboring coastal cities of Pacifica and Half Moon Bay. Among these jobs, 7,181 (63.8%) are held by individuals commuting from outside this area. A total of 2,621 of these jobs also require commutes between 10 and 24 miles, and 2,501 additional jobs require commutes of 25 miles or more.¹³ Since this preference would increase the possibility that residents of Cypress Point would already work in the region, additional traffic along State Route 92 would likely be lower than what is indicated from prevailing model numbers presented here.

¹³ Supportive data is provided in Appendix 14

95TH PERCENTILE QUEUE ANALYSIS

In addition to operations analysis, Kittelson also reviewed the changes in 95th percentile queue lengths along State Route 1 for the study intersections that include it. Queue lengths are typically evaluated as part of network-level or design-related considerations (i.e., to gauge interaction between nearby intersections). The 95th percentile queue lengths are reported to provide an appropriate storage for all but the worst 5% of traffic scenarios. This report is providing queue lengths at the request of Caltrans. Since there are no impact criteria available to evaluate queue length, this information is presented for informational purposes only.

The queue lengths presented are derived from outputs from Synchro traffic analysis software and are representative of the 95th percentile traffic volumes. Microsimulation of queues using SimTraffic, another analysis software package, was not performed because this model is typically used in the design phase of a project. For a planning level study, industry practice is to use the Synchro outputs.

Table 21 shows the 95th percentile queue lengths for the Existing, Existing with Project, Background, Background with Project, Cumulative, and Cumulative with Project conditions. A summary of how the Project may affect queues for each scenario includes:

- Existing Conditions – Most intersections maintain the same vehicle queue length except State Route 1 and Carlos Street during the AM peak hour and State Route 1 and California Avenue during the PM peak hour. At State Route 1 and California Avenue the Existing with Project scenario does not create any additional queueing on State Route 1, but the mitigated scenario introduces a traffic signal which would create a queue during the signal's red phase.
- Background Conditions – At State Route 1 and California Avenue the Background with Project scenario does not create any additional queueing on State Route 1, but the mitigated scenario introduces a traffic signal which would create a queue during the signal's red phase.
- Cumulative Conditions – The intersection of State Route 1 and California Avenue, assumed signalized under Cumulative Conditions, shows a one vehicle increase on the southbound approach in the AM peak hour and a two-vehicle increase on the northbound approach in the PM peak hour. Note that the projected queues on State Route 1 at California Avenue are in excess of 30 vehicles without the Project.

Table 21: 95th Percentile Queue Lengths (in Equivalent 25-foot Vehicle Lengths) for Intersections along State Route 1

#	Location	Control	Scenario	Existing Conditions				Background Conditions				Cumulative Conditions			
				Northbound Approach		Southbound Approach		Northbound Approach		Southbound Approach		Northbound Approach		Southbound Approach	
				Left Turn Storage Provided (Right Turn Deceleration)	95 th Percentile Left Turn Queue	Left Turn Storage Provided (Right Turn Deceleration)	95 th Percentile Left Turn Queue	Left Turn Storage Provided (Right Turn Deceleration)	95 th Percentile Left Turn Queue	Left Turn Storage Provided (Right Turn Deceleration)	95 th Percentile Left Turn Queue	Left Turn Storage Provided (Right Turn Deceleration)	95 th Percentile Left Turn Queue	Left Turn Storage Provided (Right Turn Deceleration)	95 th Percentile Left Turn Queue
1	SR 1 & 14th Street	TWSC	AM No Project	0 (4)	-	-	-	0 (4)	-	-	-	0 (4)	-	-	-
			AM with Project	0 (4)	-	-	-	0 (4)	-	-	-	0 (4)	-	-	-
			PM No Project	0 (4)	-	-	-	0 (4)	-	-	-	0 (4)	-	-	1
			PM with Project	0 (4)	-	-	-	0 (4)	-	-	-	0 (4)	-	-	1
			Sat. No Project	0 (4)	-	-	-	0 (4)	-	-	-	0 (4)	-	-	1
			Sat. with Project	0 (4)	-	-	-	0 (4)	-	-	-	0 (4)	-	-	1
2	SR 1 & 16th Street	TWSC	AM No Project	4 (0)	-	1 (0)	-	4 (0)	-	1 (0)	-	4 (0)	-	1 (0)	-
			AM with Project	4 (0)	-	1 (0)	-	4 (0)	-	1 (0)	-	4 (0)	-	1 (0)	-
			PM No Project	4 (0)	-	1 (0)	-	4 (0)	-	1 (0)	-	4 (0)	-	1 (0)	-
			PM with Project	4 (0)	-	1 (0)	-	4 (0)	-	1 (0)	-	4 (0)	-	1 (0)	-
			Sat. No Project	4 (0)	-	1(0)	-	4 (0)	-	1(0)	-	4 (0)	-	1(0)	-
			Sat. with Project	4 (0)	-	1 (0)	-	4 (0)	-	1 (0)	-	4 (0)	-	1 (0)	-
3	SR 1 & Carlos Street	TWSC	AM No Project	- (0)	-	4 (0)	-	- (0)	-	4 (0)	-	- (0)	0	4 (0)	1
			AM with Project	- (0)	-	4 (0)	-	- (0)	-	4 (0)	-	- (0)	-	4 (0)	-
			PM No Project	- (0)	-	4 (0)	1	- (0)	-	4 (0)	1	- (0)	-	4 (0)	1
			PM with Project	- (0)	-	4 (0)	-	- (0)	-	4 (0)	-	- (0)	-	4 (0)	-
			Sat. No Project	- (0)	-	4 (0)	1	- (0)	-	4 (0)	1	- (0)	-	4 (0)	-
			Sat. with Project	- (0)	-	4 (0)	-	- (0)	-	4 (0)	-	- (0)	-	4 (0)	-
6	SR 1 & Vallemar Street / Etheldore Street	TWSC	AM No Project	3 (0)	-	4 (0)	1	3 (0)	-	4 (0)	1	3 (0)	1	4 (0)	1
			AM with Project	3 (0)	-	4 (0)	1	3 (0)	-	4 (0)	1	3 (0)	1	4 (0)	1
			PM No Project	3 (0)	1	4 (0)	1	3 (0)	1	4 (0)	1	3 (0)	1	4 (0)	1
			PM with Project	3 (0)	1	4 (0)	1	3 (0)	1	4 (0)	1	3 (0)	1	4 (0)	1
			Sat. No Project	3 (0)	1	4 (0)	1	3 (0)	1	4 (0)	1	3 (0)	1	4 (0)	1
			Sat. with Project	3 (0)	1	4 (0)	1	3 (0)	1	4 (0)	1	3 (0)	1	4 (0)	1
7	SR 1 & California Avenue / Wienke Way	TWSC (Signalized in Mitigated and Cumulative scenarios)	AM No Project	3 (0)	1	4 (0)	1	3 (0)	-	4 (0)	1	3 (0)	35*	4 (0)	51*
			AM with Project	3 (0)	1	4 (0)	1	3 (0)	-	4 (0)	1	3 (0)	35*	4 (0)	53*
			AM with Project, Mit.	3 (0)	29*	4 (0)	24*	3 (0)	30*	4 (0)	26*	-	-	-	-
			PM No Project	3 (0)	-	4 (0)	1	3 (0)	1	4 (0)	1	3 (0)	64*	4 (0)	55*
			PM with Project	3 (0)	-	4 (0)	1	3 (0)	1	4 (0)	1	3 (0)	66*	4 (0)	56*
			PM with Project, Mit.	3 (0)	31*	4 (0)	42*	3 (0)	36*	4 (0)	48*	-	-	-	-
			Sat. No Project	3 (0)	1	4 (0)	1	3 (0)	1	4 (0)	1	3 (0)	32*	4 (0)	51*
			Sat with Project	3 (0)	1	4 (0)	1	3 (0)	1	4 (0)	1	3 (0)	32*	4 (0)	51*
			Sat. with Project, Mit.	3 (0)	31*	4 (0)	49*	3 (0)	36*	4 (0)	51*	-	-	-	

Notes: All "with Project" conditions represent fully mitigated scenarios. Shaded cells indicate queue lengths exceed storage. "Mit" refers to the conversion of State Route 1 & California Avenue / Wienke Way to a signal-controlled intersection (Measure TRAF 1-A)

*These queue lengths represent queued vehicles for the signalized through movement. The closest intersection to the south is approximately 250 feet away (10 car lengths) and to the north is approximately 570 feet (23 car lengths)

Appendix 1
SamTrans Service Memo

MEMORANDUM

Date: December 5, 2018

Project #: 20616

To: Andrew Bielak
MidPen Housing
303 Vintage Park Drive, Suite 250
Foster City, CA 94404

From: Mike Alston and Aaron Elias, PE
Project: Cypress Point Residential Project
Subject: SamTrans Service through Moss Beach

This memorandum presents likely transit ridership among the population at the proposed MidPen Cypress Point housing Project (“Project”), located on the northeast corner of Carlos Street and Sierra Street in Moss Beach, California. The memo also summarizes the SamTrans service through Moss Beach today and requests increased SamTrans service for Moss Beach and Project residents.

Based on historical data and staff experience from similar MidPen projects, improved transit access for Cypress Point residents would improve student access to schools. Conversely, the Project would provide increased ridership to SamTrans lines currently serving or passing through Moss Beach—particularly routes serving area schools. Thus, this memo includes a request to expand SamTrans service to and through Moss Beach; details are included in the Recommendations section.

CYPRESS POINT PROJECT

The Project proposes to provide 71 units of low-income housing (location shown in Figure 1). Based on the experience of MidPen staff, the Project residents with the greatest propensity to use SamTrans service would be children traveling to or from school. Data provided by MidPen shows an estimated 50 school-age children will live in the Project: 14 high school-age children and 36 elementary/middle school-age children.¹

Anticipated Transit Ridership

MidPen has supplied data from two projects of similar size and also serving low-income residents: Delaware Pacific and Peninsula Station, both in San Mateo, California. MidPen provides residents at

¹MidPen staff estimate 0.7 children per unit (0.5 elementary school-age children per unit and 0.2 high school-age children per unit)

both projects with the opportunity for participation in SamTrans’s Way2Go program.² Under this program MidPen purchases unlimited-ride passes for any residents who choose to participate. Residents who choose to participate in the program must register to do so (i.e., opt in) on an annual basis. Table 1 provides the level of Way2Go participation at these other projects.

Table 1: Way2Go Participation at MidPen Projects

Project	Dwelling Units	Residents	Total Residents Participating in Way2Go (including school-age children)	School-age Residents (Ages 5 – 18) Participating in Way2Go
Delaware Pacific	60	178	105 (59%)	44
Peninsula Station	68	216	118 (55%)	46

Source: MidPen Housing

These projects are similar in size to the Cypress Point project and have each accounted for an average of 45 school-age residents participating in the Way2Go program. MidPen will offer the same Way2Go participation for Cypress Point. Therefore, transit demand would be anticipated to be about the same for the Project: at least 100 residents (including at least 45 students) participating in the Way2Go program.

EXISTING SAMTRANS SERVICE

SamTrans runs two routes that pass through Moss Beach: Route 17 and Route 18. The routes and their stops are presented in Figure 1, and more detail on each route is included below.

Route 17

SamTrans route 17 follows two different northbound routes and two southbound routes. All route variations are shown in Figure 1.

Northbound

The weekday morning and weekend all-day northbound route respectively includes stops at California Avenue / Etheldore Street (0.47 miles from the project) and State Route 1 / 14th Street (0.23 miles from the project). The weekday afternoon/evening northbound route includes a stop at Etheldore Street / Sunshine Valley Road (0.62 miles from the project).

²The Way2Go website is http://www.samtrans.com/fares/faretypes/Way2Go_Program.html

Collectively, these routes operate hourly from 5:30 a.m. to 9:00 p.m. on weekdays and every other hour from 5:13 a.m. to 7:58 p.m. on weekends.

Southbound

The weekday morning southbound route includes a stop at Etheldore Street / Sunshine Valley Road (0.62 miles from the project). The weekday afternoon/evening southbound route stops at State Route 1 / 16th Street (0.11 miles from the project) and California Avenue / Etheldore Street (0.47 miles from the project).

Collectively, these routes operate hourly from 6:18 a.m. to 9:50 p.m. on weekdays and every other hour from 6:16 a.m. to 9:28 p.m. on weekends.

Route 18

SamTrans route 18 operates between Main Street / 7th Street in Montara and Moonridge Apartments near Half Moon Bay. The route travels north-south along Sunshine Valley Road and includes stops (in both directions) at Sunshine Valley Road / Etheldore Street (0.47 miles from the project). Route 18 operates two northbound buses in the morning, two northbound buses in the afternoon, three southbound buses in the morning, and two southbound buses in the afternoon.³

TRANSIT ACCESS TO SCHOOLS

School-age children will be one of the main groups of Project residents that will use transit service. The Project is currently served by three schools of the Cabrillo Unified School District including:

- Farallone View Elementary School
 - Kindergarten: 8:30 a.m. – 1:00/2:40 p.m.
 - 1st through 3rd grade: 8:30 a.m. – 2:40 p.m.⁴
 - 4th and 5th grade: 8:30 a.m. – 3:25 p.m.⁵
- Manuel F. Cunha Intermediate School
 - 8:25 a.m.⁶ – 3:05 p.m.⁷
- Half Moon Bay High School
 - 8:00 a.m. – 3:30 p.m.⁸

³ There are some exceptions to this generalization of Route 18 service. More information (including some routes which only operate on specific days) can be found at <http://www.samtrans.com/schedulesandmaps/timetables/18.html> .

⁴ 1:10 p.m. on Tuesdays

⁵ 1:10 p.m. on Tuesdays

⁶ 9:29 a.m. on Thursdays

⁷ 12:33 p.m. on early minimum days, occasionally throughout the school year

⁸ There are some exceptions to this schedule (available at the school's website here: <https://hmbhs.schoolloop.com/bell-schedules>)

Figure 2 shows the location of these schools. Table 2 provides a summary of which routes and times Project residents would need take in order to get to and from school with the existing SamTrans service. As Table 2 illustrates, Route 17 provides access only to Farallone View Elementary School. However, the nearest bus stop is 0.42 miles from school, which may not be close enough for the younger elementary students. Route 17 also provides hourly access to and from Manuel F. Cunha Intermediate School and Half Moon Bay High School, meaning that students have one Route 17 option reasonably close to the beginning or end of their school day.

Route 18 also provides service to Manuel F. Cunha Intermediate School and Half Moon Bay High School with limited service. For intermediate students and high school students, there is one convenient Route 18 bus per school day in the morning and afternoon.

Table 2: SamTrans Bus Stop Proximity to Cabrillo Unified Schools

School	Location	Nearest SamTrans Stop (distance from school)	Morning Arrival Times -- outbound from Moss Beach (to school)		Afternoon Departure Times -- Inbound to Moss Beach (from school)	
			Route 17	Route 18	Route 17	Route 18
Farallone View Elementary School	1100 Le Conte Avenue, Montara	Main Street / 4 th Street (0.42 mi)	7:40 a.m. 8:43 a.m.	n/a	12:24 p.m. 1:24 p.m. 2:27 p.m. 3:19 p.m. 4:22 p.m. 5:24 p.m.	n/a
Manuel F. Cunha Intermediate School	600 Church Street, Half Moon Bay	Kelly Avenue / Church Street (0.13 mi)	7:02 a.m. 8:02 a.m. 8:40 a.m.	8:12 a.m. ¹ 9:20 a.m. ²	3:08 p.m. 3:58 p.m. 5:00 p.m.	3:15 p.m.
Half Moon Bay High School	1 Lewis Foster Drive, Half Moon Bay	Main Street / Lewis Foster Drive (0.37 mi)	6:54 a.m. 7:53 a.m. 8:42 a.m.	7:30 a.m. 8:06 a.m. ¹ 8:25 a.m. 9:14 a.m. ²	3:00 p.m. 3:51 p.m. 4:53 p.m.	3:19 p.m. 3:50 p.m.

¹Operates on weekdays except Thursday.

²Operates on Tuesdays and Thursdays only.

Note: Not all stop times have been included; only those close to school beginning or dismissal times have been included. **Bolded** times are those arriving before school starts in the morning or leaving after school ends in the afternoon.

Source: SamTrans. More information is available at <http://www.samtrans.com/schedulesandmaps/timetables/18.html>.

RECOMMENDATIONS

The Cypress Point Project provides an opportunity for SamTrans to attract more transit riders to and from Moss Beach, particularly school-age residents traveling to and from Cabrillo Unified schools. Presently, Moss Beach residents have access to Route 17 and Route 18, which runs hourly on weekdays. Route 18 operates in tandem with the Cabrillo Unified School District schedule, providing access to Manuel F. Cunha Intermediate School and Half Moon Bay High School. Given that the Project would generate new transit riders, it is requested that SamTrans consider one or both of the following changes to service:

- Dispatch an extra Route 17 and/or Route 18 bus timed for the beginning and end of the school days. Route 18 is timed for the school schedule but only provides one morning and one afternoon bus serving Manuel F. Cunha Intermediate School and Half Moon Bay High School. Route 17 runs hourly; one extra bus running both in the morning and in the afternoon would provide more redundancy of service, especially for families and students using the bus for transportation to and from school.
- Consider locating an additional Route 17 stop closer to Farallone View Elementary School. The nearest stop is located at Main Street / 4th Street in Montara, which is a 0.42-mile walking distance from the school. Locations along Le Conte Avenue or Third Street would provide better access to the school.

These service changes would benefit Moss Beach residents through improved transit access, and SamTrans through an increased redundancy of service to encourage increased ridership.



**SamTrans Service through Moss Beach
Routes 17 and 18**

**Figure
1**

Appendix 2 Traffic Count Data

LOCATION: Cabrillo Hwy (Hwy 1) -- 14th St
CITY/STATE: Montara, CA

QC JOB #: 14384607
DATE: Thu, Apr 20 2017

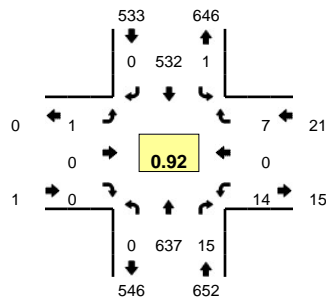

Peak-Hour: 7:45 AM -- 8:45 AM
Peak 15-Min: 8:10 AM -- 8:25 AM

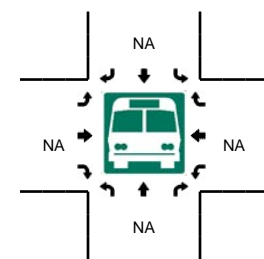
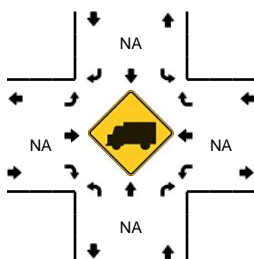
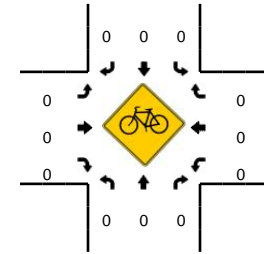
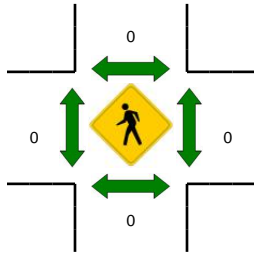
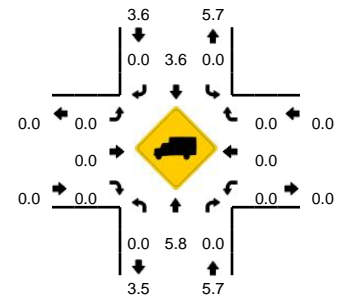

5-Min Count Period Beginning At	Cabrillo Hwy (Hwy 1) (Northbound)				Cabrillo Hwy (Hwy 1) (Southbound)				14th St (Eastbound)				14th St (Westbound)				Total	Hourly Totals	
	Left	Thru	Right	U	Left	Thru	Right	U	Left	Thru	Right	U	Left	Thru	Right	U			
7:00 AM	0	59	0	0	0	23	0	0	0	0	0	0	0	0	0	1	0	83	
7:05 AM	0	50	0	0	0	22	0	0	0	0	0	0	0	1	0	0	0	73	
7:10 AM	0	49	0	0	0	33	0	0	0	0	0	0	0	2	0	4	0	88	
7:15 AM	0	57	0	0	0	24	0	0	0	0	0	0	0	0	0	0	0	81	
7:20 AM	0	62	0	0	0	26	0	0	0	0	0	0	0	2	0	1	0	91	
7:25 AM	0	47	0	0	0	30	0	0	0	0	0	0	0	1	0	0	0	78	
7:30 AM	0	55	0	0	0	21	0	0	0	0	0	0	0	2	0	1	0	79	
7:35 AM	0	51	0	0	0	37	0	0	0	0	0	0	0	4	0	0	0	92	
7:40 AM	0	60	0	0	0	38	0	0	0	0	0	0	0	0	0	2	0	100	
7:45 AM	0	55	0	0	0	46	0	0	0	0	0	0	0	0	0	0	0	101	
7:50 AM	0	59	1	0	0	52	0	0	1	0	0	0	0	3	0	0	0	116	
7:55 AM	0	48	0	0	0	34	0	0	0	0	0	0	0	2	0	2	0	86	1068
8:00 AM	0	50	1	0	0	22	0	0	0	0	0	0	0	1	0	0	0	74	1059
8:05 AM	0	42	0	0	0	39	0	0	0	0	0	0	0	4	0	0	0	85	1071
8:10 AM	0	55	4	0	0	42	0	0	0	0	0	0	0	0	0	1	0	102	1085
8:15 AM	0	66	0	0	0	41	0	0	0	0	0	0	0	0	0	0	0	107	1111
8:20 AM	0	73	1	0	0	44	0	0	0	0	0	0	0	0	0	1	0	119	1139
8:25 AM	0	49	4	0	0	42	0	0	0	0	0	0	0	1	0	1	0	97	1158
8:30 AM	0	38	1	0	0	48	0	1	0	0	0	0	0	0	0	0	0	88	1167
8:35 AM	0	50	1	0	0	65	0	0	0	0	0	0	0	3	0	1	0	120	1195
8:40 AM	0	52	2	0	0	57	0	0	0	0	0	0	0	0	0	1	0	112	1207
8:45 AM	0	37	1	0	0	31	0	0	0	0	0	0	0	1	0	0	0	70	1176
8:50 AM	0	40	1	0	0	38	0	0	0	0	0	0	0	0	0	0	0	79	1139
8:55 AM	0	39	0	0	0	39	0	0	0	0	0	0	0	1	0	0	0	79	1132
Peak 15-Min Flowrates	Northbound				Southbound				Eastbound				Westbound				Total		
	Left	Thru	Right	U	Left	Thru	Right	U	Left	Thru	Right	U	Left	Thru	Right	U			
All Vehicles	0	776	20	0	0	508	0	0	0	0	0	0	0	0	0	8	0	1312	
Heavy Trucks	0	40	0	0	0	4	0	0	0	0	0	0	0	0	0	0	0	44	
Pedestrians	0	0	0	0	0	0	0	0	0	0	0	0	0	0	0	0	0	0	
Bicycles	0	0	0	0	0	0	0	0	0	0	0	0	0	0	0	0	0	0	
Railroad	0	0	0	0	0	0	0	0	0	0	0	0	0	0	0	0	0	0	
Stopped Buses	0	0	0	0	0	0	0	0	0	0	0	0	0	0	0	0	0	0	

Comments:

LOCATION: Cabrillo Hwy (Hwy 1) -- 14th St
CITY/STATE: Montara, CA

QC JOB #: 14384608
DATE: Thu, Apr 20 2017

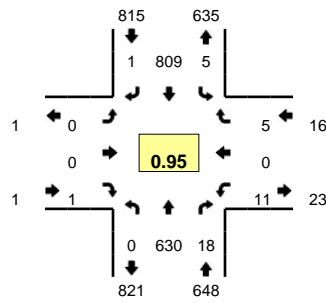

Peak-Hour: 4:45 PM -- 5:45 PM
Peak 15-Min: 4:55 PM -- 5:10 PM

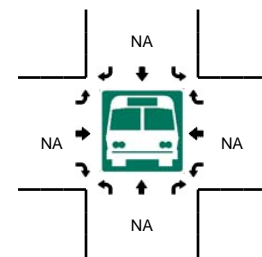
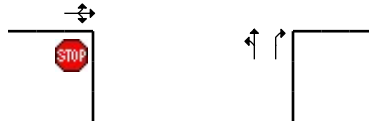
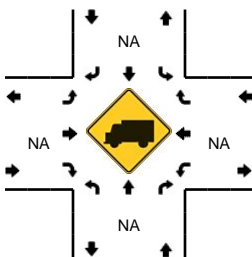
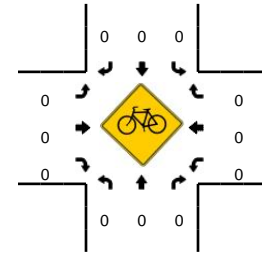
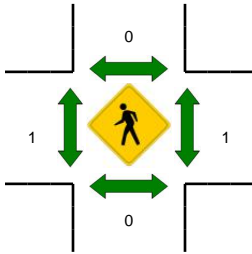
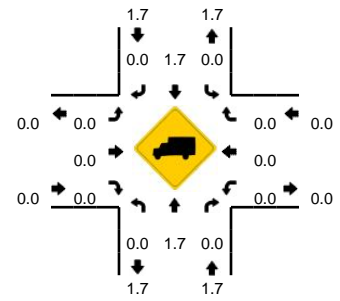

5-Min Count Period Beginning At	Cabrillo Hwy (Hwy 1) (Northbound)				Cabrillo Hwy (Hwy 1) (Southbound)				14th St (Eastbound)				14th St (Westbound)				Total	Hourly Totals
	Left	Thru	Right	U	Left	Thru	Right	U	Left	Thru	Right	U	Left	Thru	Right	U		
4:00 PM	0	69	2	0	0	69	0	0	0	0	0	0	3	0	1	0	144	
4:05 PM	0	53	2	0	0	69	0	0	0	0	0	0	0	0	0	0	124	
4:10 PM	0	47	3	0	1	51	0	0	0	0	0	0	0	0	0	0	102	
4:15 PM	1	56	1	0	1	72	0	0	0	0	0	0	0	0	0	0	131	
4:20 PM	0	55	0	0	1	51	0	0	1	0	0	0	3	0	0	0	111	
4:25 PM	0	55	1	0	0	62	0	0	0	0	0	0	1	0	0	0	119	
4:30 PM	1	51	1	0	1	49	0	0	1	0	0	0	0	0	0	0	104	
4:35 PM	0	55	0	0	0	68	0	0	0	0	0	0	0	0	0	0	123	
4:40 PM	0	43	1	0	0	54	0	0	0	0	0	0	0	0	1	0	99	
4:45 PM	0	49	1	0	0	86	0	0	0	0	0	0	1	0	1	0	138	
4:50 PM	0	51	2	0	1	62	0	0	0	0	0	0	0	0	2	0	118	
4:55 PM	0	45	2	0	2	79	0	0	0	0	0	0	0	0	0	0	128	1441
5:00 PM	0	61	1	0	0	65	0	0	0	0	0	0	2	0	0	0	129	1426
5:05 PM	0	60	2	0	0	70	0	0	0	0	0	0	2	0	0	0	134	1436
5:10 PM	0	42	0	0	0	57	0	0	0	0	0	0	1	0	2	0	102	1436
5:15 PM	0	57	2	0	0	66	0	0	0	0	1	0	1	0	0	0	127	1432
5:20 PM	0	53	0	0	1	65	0	0	0	0	0	0	1	0	0	0	120	1441
5:25 PM	0	53	1	0	0	75	0	0	0	0	0	0	0	0	0	0	129	1451
5:30 PM	0	48	3	0	0	49	0	0	0	0	0	0	0	0	0	0	100	1447
5:35 PM	0	58	2	0	0	77	1	0	0	0	0	0	2	0	0	0	140	1464
5:40 PM	0	53	2	0	1	58	0	0	0	0	0	0	1	0	0	0	115	1480
5:45 PM	0	41	1	0	1	54	0	0	0	0	0	0	0	0	0	0	97	1439
5:50 PM	1	49	2	0	0	67	0	0	0	0	0	0	0	0	0	0	119	1440
5:55 PM	1	55	6	0	0	71	0	0	0	0	0	0	1	0	0	0	134	1446
Peak 15-Min Flowrates	Northbound				Southbound				Eastbound				Westbound				Total	
	Left	Thru	Right	U	Left	Thru	Right	U	Left	Thru	Right	U	Left	Thru	Right	U		
All Vehicles	0	664	20	0	8	856	0	0	0	0	0	0	16	0	0	0	1564	
Heavy Trucks	0	20	0	0	0	8	0	0	0	0	0	0	0	0	0	0	28	
Pedestrians	0	0	0	0	0	0	0	0	0	0	0	0	0	0	0	0	0	
Bicycles	0	0	0	0	0	0	0	0	0	0	0	0	0	0	0	0	0	
Railroad																		
Stopped Buses																		

Comments:

LOCATION: Cabrillo Hwy (Hwy 1) -- 14th St
CITY/STATE: Montara, CA

QC JOB #: 14384609
DATE: Sat, Apr 22 2017

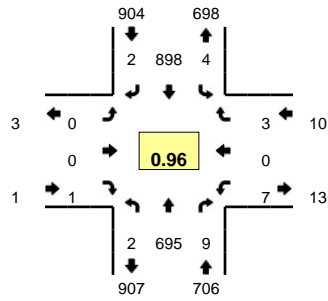

Peak-Hour: 11:55 AM -- 12:55 PM
Peak 15-Min: 11:55 AM -- 12:10 PM

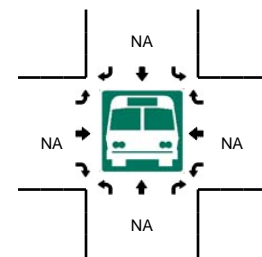
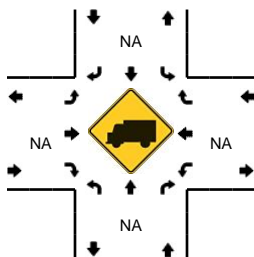
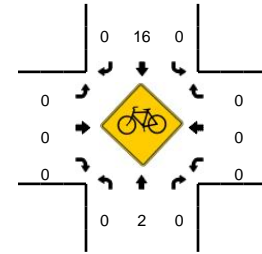
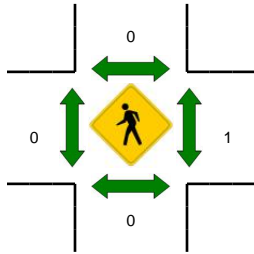
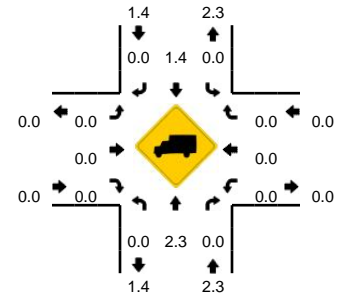

5-Min Count Period Beginning At	Cabrillo Hwy (Hwy 1) (Northbound)				Cabrillo Hwy (Hwy 1) (Southbound)				14th St (Eastbound)				14th St (Westbound)				Total	Hourly Totals
	Left	Thru	Right	U	Left	Thru	Right	U	Left	Thru	Right	U	Left	Thru	Right	U		
11:00 AM	0	53	0	0	0	62	0	0	0	0	0	0	1	0	0	0	116	
11:05 AM	0	50	1	0	0	76	0	0	0	0	0	0	3	0	0	0	130	
11:10 AM	0	59	1	0	0	72	0	0	0	0	0	0	0	0	0	0	132	
11:15 AM	0	60	2	0	0	61	1	0	0	0	0	0	2	0	1	0	127	
11:20 AM	0	50	1	0	0	82	0	0	1	0	0	0	1	0	0	0	135	
11:25 AM	0	70	2	0	0	73	0	0	0	0	0	0	0	0	0	0	145	
11:30 AM	0	37	0	0	0	82	0	0	0	0	0	0	0	0	1	0	120	
11:35 AM	0	58	0	0	0	73	0	0	0	0	0	0	0	0	0	0	131	
11:40 AM	0	37	1	0	0	89	0	0	0	0	0	0	1	0	0	0	128	
11:45 AM	0	45	0	0	0	71	0	0	0	0	0	0	1	0	0	0	117	
11:50 AM	0	41	0	0	0	72	0	0	0	0	0	0	0	0	1	0	114	
11:55 AM	0	50	1	0	0	89	0	0	0	0	0	0	0	0	0	0	140	1535
12:00 PM	0	69	1	0	2	86	0	0	0	0	0	0	1	0	0	0	159	1578
12:05 PM	0	42	1	0	0	81	0	0	0	0	0	0	0	0	0	0	124	1572
12:10 PM	0	59	1	0	1	71	0	0	0	0	0	0	0	0	0	0	132	1572
12:15 PM	0	61	2	0	1	77	0	0	0	0	0	0	0	0	0	0	141	1586
12:20 PM	0	58	0	0	0	79	0	0	0	0	0	0	0	0	0	0	137	1588
12:25 PM	0	55	0	0	0	72	0	0	0	0	0	0	2	0	1	0	130	1573
12:30 PM	0	72	0	0	0	54	0	0	0	0	0	0	1	0	1	0	128	1581
12:35 PM	0	49	1	0	0	75	1	0	0	0	0	0	1	0	0	0	127	1577
12:40 PM	1	53	2	0	0	64	1	0	0	0	1	0	1	0	0	0	123	1572
12:45 PM	0	64	0	1	0	69	0	0	0	0	0	0	0	0	0	0	134	1589
12:50 PM	0	63	0	0	0	81	0	0	0	0	0	0	1	0	1	0	146	1621
12:55 PM	0	53	0	0	0	62	0	0	1	0	0	0	2	0	0	0	118	1599
Peak 15-Min Flowrates	Northbound				Southbound				Eastbound				Westbound				Total	
	Left	Thru	Right	U	Left	Thru	Right	U	Left	Thru	Right	U	Left	Thru	Right	U		
All Vehicles	0	644	12	0	8	1024	0	0	0	0	0	0	4	0	0	0	1692	
Heavy Trucks	0	12	0	0	0	4	0	0	0	0	0	0	0	0	0	0	16	
Pedestrians	0	0	0	0	0	0	0	0	0	0	0	0	0	0	0	0	0	
Bicycles	0	0	0	0	0	5	0	0	0	0	0	0	0	0	0	0	5	
Railroad																		
Stopped Buses																		

Comments:

LOCATION: Cabrillo Hwy (Hwy 1) -- 16th St
CITY/STATE: Montara, CA

QC JOB #: 14384604
DATE: Thu, Apr 20 2017

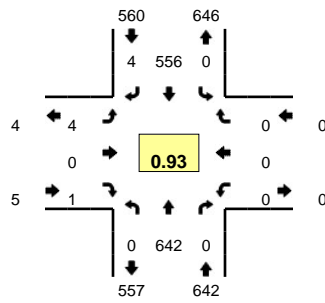

Peak-Hour: 7:45 AM -- 8:45 AM
Peak 15-Min: 8:10 AM -- 8:25 AM

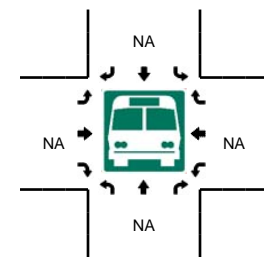
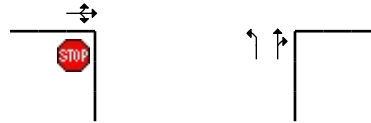
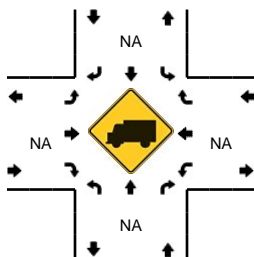
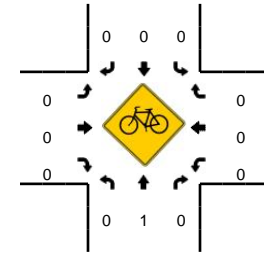
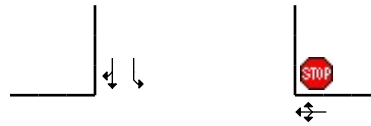
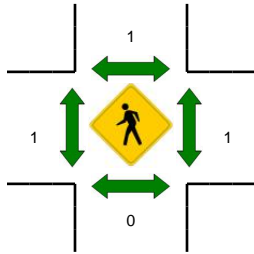
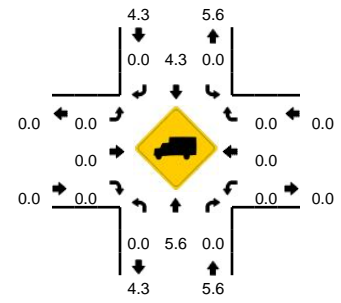

5-Min Count Period Beginning At	Cabrillo Hwy (Hwy 1) (Northbound)				Cabrillo Hwy (Hwy 1) (Southbound)				16th St (Eastbound)				16th St (Westbound)				Total	Hourly Totals	
	Left	Thru	Right	U	Left	Thru	Right	U	Left	Thru	Right	U	Left	Thru	Right	U			
7:00 AM	0	58	0	0	0	21	0	0	0	0	0	0	0	0	0	0	79		
7:05 AM	0	55	0	0	0	24	1	0	0	0	0	0	0	0	0	0	80		
7:10 AM	0	47	0	0	0	35	0	0	0	0	0	0	0	0	0	0	82		
7:15 AM	0	55	0	0	0	25	0	0	0	0	0	0	0	0	0	0	80		
7:20 AM	0	43	0	0	0	25	0	0	0	0	0	0	0	0	0	0	68		
7:25 AM	2	46	0	0	0	31	0	0	0	0	0	0	0	0	0	0	79		
7:30 AM	0	53	0	0	0	22	0	0	1	0	0	0	0	0	0	0	76		
7:35 AM	0	51	0	0	0	45	0	0	1	0	0	0	1	0	0	0	98		
7:40 AM	0	56	0	0	0	35	0	0	0	0	0	0	0	0	0	0	91		
7:45 AM	0	58	0	0	0	49	1	0	0	0	0	0	0	0	0	0	108		
7:50 AM	0	57	0	0	0	57	1	0	3	0	0	0	0	0	0	0	118		
7:55 AM	0	48	0	0	0	35	0	0	0	0	0	0	0	0	0	0	83	1042	
8:00 AM	0	48	0	0	0	23	0	0	0	0	1	0	0	0	0	0	72	1035	
8:05 AM	0	44	0	0	0	44	0	0	0	0	0	0	0	0	0	0	88	1043	
8:10 AM	0	59	0	0	0	45	0	0	0	0	0	0	0	0	0	0	104	1065	
8:15 AM	0	62	0	0	0	42	0	0	0	0	0	0	0	0	0	0	104	1089	
8:20 AM	0	71	0	0	0	43	1	0	0	0	0	0	0	0	0	0	115	1136	
8:25 AM	0	56	0	0	0	45	0	0	0	0	0	0	0	0	0	0	101	1158	
8:30 AM	0	35	0	0	0	46	1	0	0	0	0	0	0	0	0	0	82	1164	
8:35 AM	0	50	0	0	0	71	0	0	1	0	0	0	0	0	0	0	122	1188	
8:40 AM	0	54	0	0	0	56	0	0	0	0	0	0	0	0	0	0	110	1207	
8:45 AM	0	33	0	0	0	33	1	0	0	0	0	0	0	0	0	0	67	1166	
8:50 AM	0	45	0	0	0	41	1	0	0	0	0	0	0	0	0	0	87	1135	
8:55 AM	0	36	0	0	0	40	0	0	1	0	0	0	1	0	1	0	79	1131	
Peak 15-Min Flowrates	Northbound				Southbound				Eastbound				Westbound				Total		
	Left	Thru	Right	U	Left	Thru	Right	U	Left	Thru	Right	U	Left	Thru	Right	U			
All Vehicles	0	768	0	0	0	520	4	0	0	0	0	0	0	0	0	0	1292		
Heavy Trucks	0	44	0	0	0	8	0	0	0	0	0	0	0	0	0	0	52		
Pedestrians		0				0				0				0			0		
Bicycles	0	1	0		0	0	0		0	0	0		0	0	0		1		
Railroad																			
Stopped Buses																			

Comments:

LOCATION: Cabrillo Hwy (Hwy 1) -- 16th St
CITY/STATE: Montara, CA

QC JOB #: 14384605
DATE: Thu, Apr 20 2017

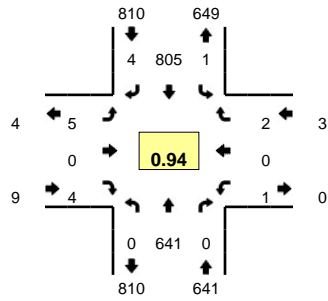

Peak-Hour: 4:45 PM -- 5:45 PM
Peak 15-Min: 4:55 PM -- 5:10 PM

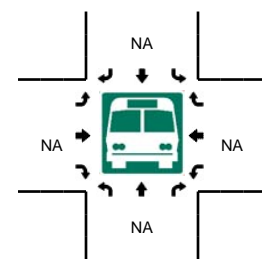
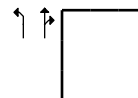
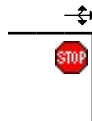
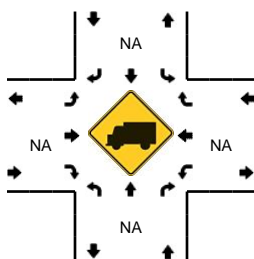
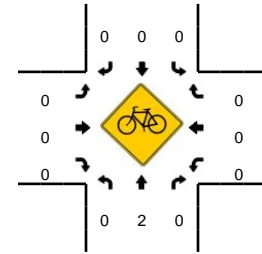
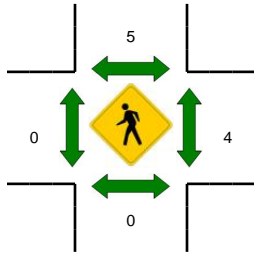
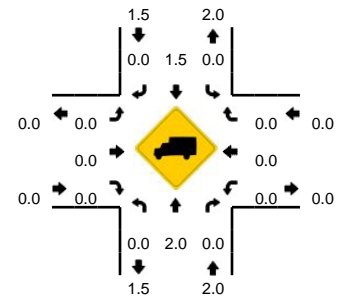

5-Min Count Period Beginning At	Cabrillo Hwy (Hwy 1) (Northbound)				Cabrillo Hwy (Hwy 1) (Southbound)				16th St (Eastbound)				16th St (Westbound)				Total	Hourly Totals	
	Left	Thru	Right	U	Left	Thru	Right	U	Left	Thru	Right	U	Left	Thru	Right	U			
4:00 PM	0	58	0	0	0	70	0	0	2	0	2	0	0	0	0	0	132		
4:05 PM	0	53	0	0	0	71	0	0	0	0	1	0	0	0	0	0	125		
4:10 PM	1	50	0	0	0	48	0	0	0	0	0	0	0	0	0	0	99		
4:15 PM	0	56	0	0	0	72	2	0	1	0	0	0	0	0	0	0	131		
4:20 PM	0	56	0	0	0	55	1	0	0	0	0	0	0	0	0	0	112		
4:25 PM	0	55	0	0	0	58	1	0	0	0	0	0	0	0	0	0	114		
4:30 PM	1	53	0	0	0	53	0	0	4	0	0	0	0	0	0	0	111		
4:35 PM	0	49	1	0	0	64	0	0	0	0	0	0	0	0	0	0	114		
4:40 PM	0	45	0	0	0	61	0	0	0	0	0	0	0	0	0	0	106		
4:45 PM	0	55	0	0	0	79	0	0	0	0	0	0	0	0	1	0	135		
4:50 PM	0	45	0	0	0	62	0	0	0	0	0	0	0	0	0	0	107		
4:55 PM	0	45	0	0	0	82	0	0	0	0	0	0	0	0	0	0	127	1413	
5:00 PM	0	68	0	0	0	64	1	0	1	0	0	0	0	0	0	0	134	1415	
5:05 PM	0	52	0	0	0	70	2	1	2	0	0	0	0	0	0	0	127	1417	
5:10 PM	0	51	0	0	0	59	0	0	0	0	2	0	0	0	0	0	112	1430	
5:15 PM	0	53	0	0	0	64	1	0	0	0	0	0	0	0	0	0	118	1417	
5:20 PM	0	56	0	0	0	67	0	0	0	0	1	0	0	0	0	0	124	1429	
5:25 PM	0	49	0	0	0	76	0	0	1	0	0	0	0	0	0	0	126	1441	
5:30 PM	0	52	0	0	0	49	0	0	1	0	0	0	1	0	1	0	104	1434	
5:35 PM	0	62	0	0	0	74	0	0	0	0	1	0	0	0	0	0	137	1457	
5:40 PM	0	53	0	0	0	59	0	0	0	0	0	0	0	0	0	0	112	1463	
5:45 PM	0	37	0	0	0	57	0	0	0	0	0	0	0	0	0	0	94	1422	
5:50 PM	0	53	0	0	0	65	0	0	0	0	0	0	0	0	0	0	118	1433	
5:55 PM	0	62	0	0	1	73	1	0	0	0	0	0	0	0	0	0	137	1443	
Peak 15-Min Flowrates	Northbound				Southbound				Eastbound				Westbound				Total		
	Left	Thru	Right	U	Left	Thru	Right	U	Left	Thru	Right	U	Left	Thru	Right	U			
All Vehicles	0	660	0	0	0	864	12	4	12	0	0	0	0	0	0	0	1552		
Heavy Trucks	0	28	0	0	0	8	0	0	0	0	0	0	0	0	0	0	36		
Pedestrians		0				12				0				4			16		
Bicycles	0	0	0		0	0	0		0	0	0		0	0	0		0		
Railroad																			
Stopped Buses																			

Comments:

LOCATION: Cabrillo Hwy (Hwy 1) -- 16th St
CITY/STATE: Montara, CA

QC JOB #: 14384606
DATE: Sat, Apr 22 2017

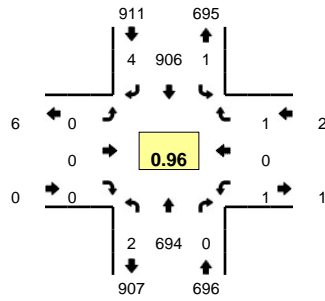

Peak-Hour: 11:55 AM -- 12:55 PM
Peak 15-Min: 12:10 PM -- 12:25 PM

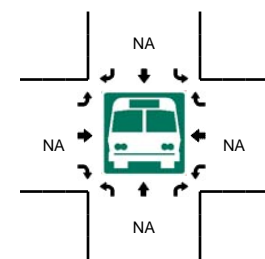
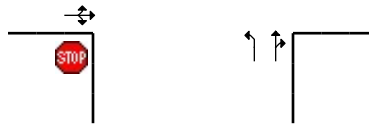
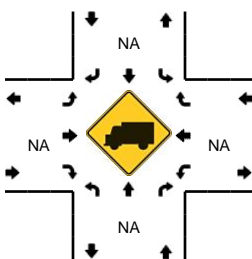
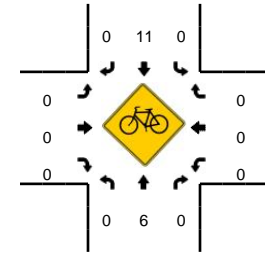
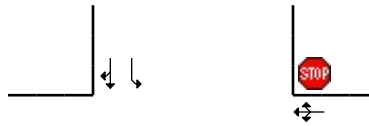
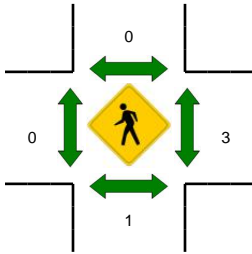
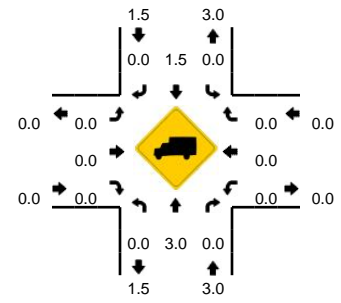

5-Min Count Period Beginning At	Cabrillo Hwy (Hwy 1) (Northbound)				Cabrillo Hwy (Hwy 1) (Southbound)				16th St (Eastbound)				16th St (Westbound)				Total	Hourly Totals	
	Left	Thru	Right	U	Left	Thru	Right	U	Left	Thru	Right	U	Left	Thru	Right	U			
11:00 AM	0	54	0	0	0	67	0	0	0	0	0	0	0	0	0	0	121		
11:05 AM	0	59	0	0	0	77	0	0	0	0	0	0	0	0	0	0	136		
11:10 AM	0	53	0	0	0	75	0	0	0	0	0	0	0	0	0	0	128		
11:15 AM	0	62	0	0	0	62	0	0	0	0	0	0	0	0	0	0	124		
11:20 AM	0	49	0	0	0	84	1	0	0	0	0	0	0	0	0	0	134		
11:25 AM	0	69	0	0	0	71	0	0	0	0	0	1	0	0	0	0	141		
11:30 AM	0	44	0	0	0	82	2	0	0	0	0	1	0	0	0	0	129		
11:35 AM	0	51	0	0	0	75	0	0	0	0	0	0	0	0	0	0	126		
11:40 AM	1	38	0	0	0	88	0	0	1	0	1	0	1	0	0	0	130		
11:45 AM	0	43	0	0	0	73	0	0	0	0	0	0	0	0	0	0	116		
11:50 AM	0	45	0	0	0	70	0	0	1	0	0	0	0	0	0	0	116		
11:55 AM	0	48	0	0	0	93	0	0	0	0	0	0	0	0	0	0	141	1542	
12:00 PM	0	68	0	0	0	81	0	0	0	0	0	0	0	0	0	0	149	1570	
12:05 PM	0	42	0	0	1	82	0	0	0	0	0	0	0	0	0	0	125	1559	
12:10 PM	1	68	0	0	0	72	0	0	0	0	0	0	0	0	0	0	141	1572	
12:15 PM	0	58	0	0	0	80	0	0	0	0	0	0	0	0	0	0	138	1586	
12:20 PM	0	60	0	0	0	78	0	0	0	0	0	0	0	0	0	0	138	1590	
12:25 PM	0	54	0	0	0	74	0	0	0	0	0	0	0	0	0	0	128	1577	
12:30 PM	1	69	0	0	0	55	0	0	0	0	0	0	0	0	0	0	125	1573	
12:35 PM	0	47	0	0	0	76	0	0	0	0	0	0	0	0	0	0	123	1570	
12:40 PM	0	51	0	0	0	63	1	0	0	0	0	0	0	1	0	0	116	1556	
12:45 PM	0	70	0	0	0	71	2	0	0	0	0	0	1	0	0	0	144	1584	
12:50 PM	0	59	0	0	0	81	1	0	0	0	0	0	0	0	0	0	141	1609	
12:55 PM	1	56	0	0	0	67	0	0	0	0	0	2	0	0	0	0	126	1594	
Peak 15-Min Flowrates	Northbound				Southbound				Eastbound				Westbound				Total		
	Left	Thru	Right	U	Left	Thru	Right	U	Left	Thru	Right	U	Left	Thru	Right	U			
All Vehicles	4	744	0	0	0	920	0	0	0	0	0	0	0	0	0	0	1668		
Heavy Trucks	0	12	0	0	0	8	0	0	0	0	0	0	0	0	0	0	20		
Pedestrians		0				0					0						0		
Bicycles	0	3	0		0	1	0		0	0	0		0	0	0		4		
Railroad																			
Stopped Buses																			

Comments:

LOCATION: Cabrillo Hwy (Hwy 1) -- Carlos St
CITY/STATE: Montara, CA

QC JOB #: 14384601
DATE: Thu, Apr 20 2017

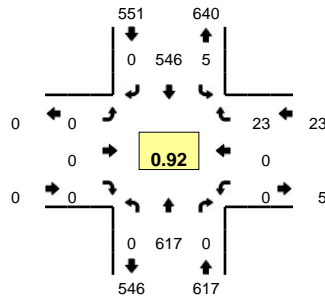

Peak-Hour: 7:45 AM -- 8:45 AM
Peak 15-Min: 8:10 AM -- 8:25 AM

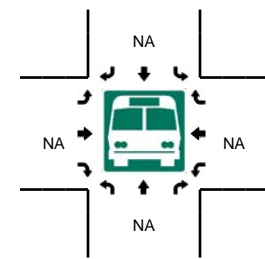
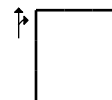
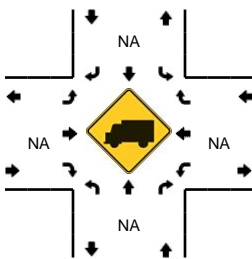
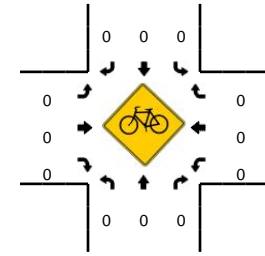
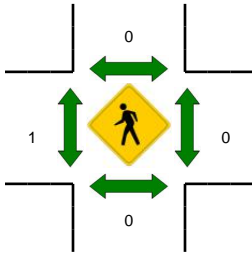
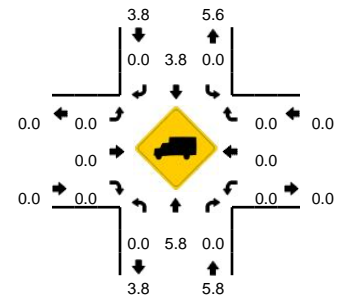

5-Min Count Period Beginning At	Cabrillo Hwy (Hwy 1) (Northbound)				Cabrillo Hwy (Hwy 1) (Southbound)				Carlos St (Eastbound)				Carlos St (Westbound)				Total	Hourly Totals	
	Left	Thru	Right	U	Left	Thru	Right	U	Left	Thru	Right	U	Left	Thru	Right	U			
7:00 AM	0	55	0	0	0	23	0	0	0	0	0	0	0	0	0	4	0	82	
7:05 AM	0	50	0	0	1	23	0	0	0	0	0	0	0	0	0	0	0	74	
7:10 AM	0	49	0	0	0	33	0	0	0	0	0	0	0	0	0	0	0	82	
7:15 AM	0	53	0	0	1	25	0	0	0	0	0	0	0	0	0	3	0	82	
7:20 AM	0	62	0	0	0	28	0	0	0	0	0	0	0	0	0	2	0	92	
7:25 AM	0	44	0	0	0	27	0	0	0	0	0	0	0	0	0	3	0	74	
7:30 AM	0	54	0	0	1	23	0	0	0	0	0	0	0	0	0	0	0	78	
7:35 AM	0	50	0	0	1	40	0	0	0	0	0	0	0	0	0	0	0	91	
7:40 AM	0	59	0	0	0	39	0	0	0	0	0	0	0	0	0	1	0	99	
7:45 AM	0	53	0	0	0	46	0	0	0	0	0	0	0	0	0	1	0	100	
7:50 AM	0	57	0	0	1	57	0	0	0	0	0	0	0	0	0	2	0	117	
7:55 AM	0	44	0	0	0	36	0	0	0	0	0	0	0	0	0	2	0	82	1053
8:00 AM	0	50	0	0	0	24	0	0	0	0	0	0	0	0	0	1	0	75	1046
8:05 AM	0	38	0	0	0	42	0	0	0	0	0	0	0	0	0	3	0	83	1055
8:10 AM	0	56	0	0	0	41	0	0	0	0	0	0	0	0	0	3	0	100	1073
8:15 AM	0	64	0	0	0	45	0	0	0	0	0	0	0	0	0	1	0	110	1101
8:20 AM	0	71	0	0	2	40	0	0	0	0	0	0	0	0	0	1	0	114	1123
8:25 AM	0	49	0	0	0	42	0	0	0	0	0	0	0	0	0	5	0	96	1145
8:30 AM	0	37	0	0	0	50	0	0	0	0	0	0	0	0	0	1	0	88	1155
8:35 AM	0	51	0	0	2	67	0	0	0	0	0	0	0	0	0	0	0	120	1184
8:40 AM	0	47	0	0	0	56	0	0	0	0	0	0	0	0	0	3	0	106	1191
8:45 AM	0	39	0	0	0	37	0	0	0	0	0	0	0	0	0	0	0	76	1167
8:50 AM	0	40	0	0	0	40	0	0	0	0	0	0	0	0	0	0	0	80	1130
8:55 AM	0	37	0	0	0	39	0	0	0	0	0	0	0	0	0	0	0	76	1124
Peak 15-Min Flowrates	Northbound				Southbound				Eastbound				Westbound				Total		
	Left	Thru	Right	U	Left	Thru	Right	U	Left	Thru	Right	U	Left	Thru	Right	U			
All Vehicles	0	764	0	0	8	504	0	0	0	0	0	0	0	0	20	0	1296		
Heavy Trucks	0	44	0	0	0	8	0	0	0	0	0	0	0	0	0	0	52		
Pedestrians	0	0	0	0	0	0	0	0	0	0	0	0	0	0	0	0	0		
Bicycles	0	0	0	0	0	0	0	0	0	0	0	0	0	0	0	0	0		
Railroad																		0	
Stopped Buses																		0	

Comments:

Type of peak hour being reported: Intersection Peak

Method for determining peak hour: Total Entering Volume

LOCATION: Cabrillo Hwy (Hwy 1) -- Carlos St
CITY/STATE: Montara, CA

QC JOB #: 14384602
DATE: Thu, Apr 20 2017

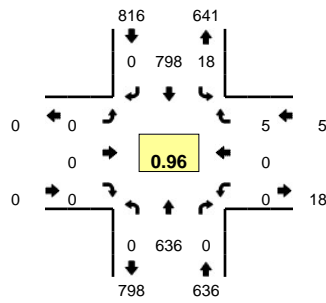

Peak-Hour: 4:45 PM -- 5:45 PM
Peak 15-Min: 4:55 PM -- 5:10 PM

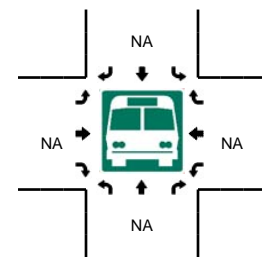
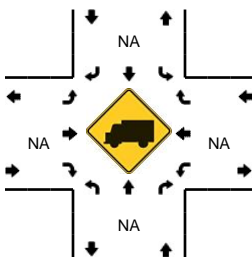
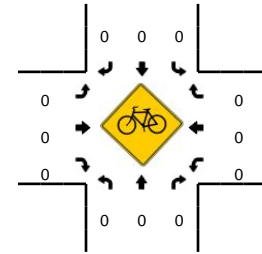
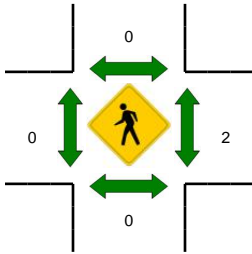
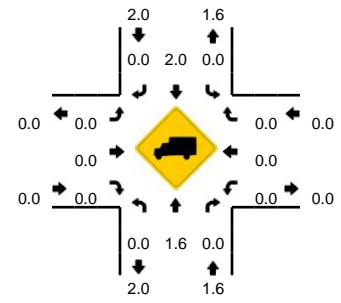

5-Min Count Period Beginning At	Cabrillo Hwy (Hwy 1) (Northbound)				Cabrillo Hwy (Hwy 1) (Southbound)				Carlos St (Eastbound)				Carlos St (Westbound)				Total	Hourly Totals
	Left	Thru	Right	U	Left	Thru	Right	U	Left	Thru	Right	U	Left	Thru	Right	U		
4:00 PM	0	66	0	0	0	76	0	0	0	0	0	0	0	0	1	0	143	
4:05 PM	0	53	0	0	2	69	0	0	0	0	0	0	0	0	1	0	125	
4:10 PM	0	51	0	0	0	47	0	0	0	0	0	0	0	0	0	0	98	
4:15 PM	0	57	0	0	1	70	0	0	0	0	0	0	0	0	0	0	128	
4:20 PM	0	53	0	0	1	44	0	0	0	0	0	0	0	0	1	0	99	
4:25 PM	0	57	0	0	0	73	0	0	0	0	0	0	0	0	0	0	130	
4:30 PM	0	50	0	0	1	44	0	0	0	0	0	0	0	0	1	0	96	
4:35 PM	0	56	0	0	1	70	0	0	0	0	0	0	0	0	0	0	127	
4:40 PM	0	42	0	0	0	58	0	0	0	0	0	0	0	0	0	0	100	
4:45 PM	0	50	0	0	2	76	0	0	0	0	0	0	0	0	0	0	128	
4:50 PM	0	52	0	0	3	61	0	0	0	0	0	0	0	0	0	0	116	
4:55 PM	0	47	0	0	0	79	0	0	0	0	0	0	0	0	0	0	126	1416
5:00 PM	0	62	0	0	1	62	0	0	0	0	0	0	0	0	0	0	125	1398
5:05 PM	0	59	0	0	3	65	0	0	0	0	0	0	0	0	0	0	127	1400
5:10 PM	0	39	0	0	2	57	0	0	0	0	0	0	0	0	2	0	100	1402
5:15 PM	0	59	0	0	1	68	0	0	0	0	0	0	0	0	0	0	128	1402
5:20 PM	0	49	0	0	1	70	0	0	0	0	0	0	0	0	1	0	121	1424
5:25 PM	0	56	0	0	3	68	0	0	0	0	0	0	0	0	0	0	127	1421
5:30 PM	0	49	0	0	1	54	0	0	0	0	0	0	0	0	0	0	104	1429
5:35 PM	0	59	0	0	1	79	0	0	0	0	0	0	0	0	2	0	141	1443
5:40 PM	0	55	0	0	0	59	0	0	0	0	0	0	0	0	0	0	114	1457
5:45 PM	0	42	0	0	3	53	0	0	0	0	0	0	0	0	0	0	98	1427
5:50 PM	0	48	0	0	2	56	0	0	0	0	0	0	0	0	3	0	109	1420
5:55 PM	0	62	0	0	3	75	0	0	0	0	0	0	0	0	1	0	141	1435
Peak 15-Min Flowrates	Northbound				Southbound				Eastbound				Westbound				Total	
	Left	Thru	Right	U	Left	Thru	Right	U	Left	Thru	Right	U	Left	Thru	Right	U		
All Vehicles	0	672	0	0	16	824	0	0	0	0	0	0	0	0	0	0	1512	
Heavy Trucks	0	16	0	0	0	12	0	0	0	0	0	0	0	0	0	0	28	
Pedestrians	0	0	0	0	0	0	0	0	0	0	0	0	0	0	0	0	0	
Bicycles	0	0	0	0	0	0	0	0	0	0	0	0	0	0	0	0	0	
Railroad																		
Stopped Buses																		

Comments:

LOCATION: Cabrillo Hwy (Hwy 1) -- Carlos St
CITY/STATE: Montara, CA

QC JOB #: 14384603
DATE: Sat, Apr 22 2017

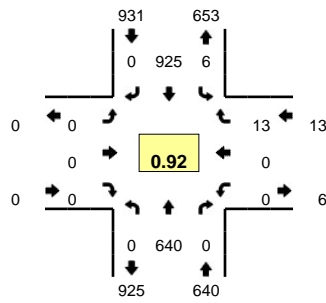

Peak-Hour: 11:35 AM -- 12:35 PM
Peak 15-Min: 12:15 PM -- 12:30 PM

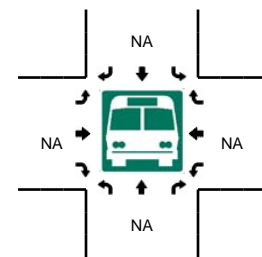
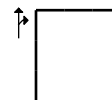
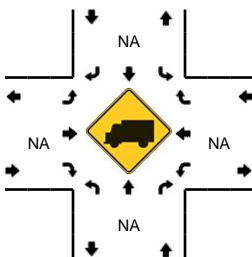
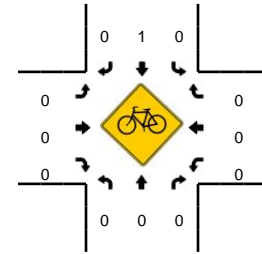
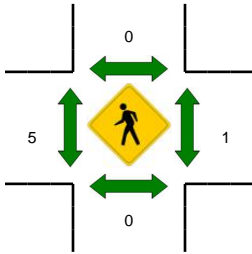
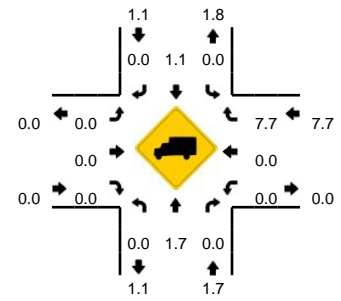

5-Min Count Period Beginning At	Cabrillo Hwy (Hwy 1) (Northbound)				Cabrillo Hwy (Hwy 1) (Southbound)				Carlos St (Eastbound)				Carlos St (Westbound)				Total	Hourly Totals	
	Left	Thru	Right	U	Left	Thru	Right	U	Left	Thru	Right	U	Left	Thru	Right	U			
11:00 AM	0	50	0	0	2	61	0	0	0	0	0	0	0	0	0	1	0	114	
11:05 AM	0	57	0	0	0	82	0	0	0	0	0	0	0	0	0	0	0	139	
11:10 AM	0	60	0	0	0	74	0	0	0	0	0	0	0	0	0	0	0	134	
11:15 AM	0	54	0	0	0	64	0	0	0	0	0	0	0	0	0	0	0	118	
11:20 AM	0	56	0	0	0	84	0	0	0	0	0	0	0	0	1	0	0	141	
11:25 AM	0	69	0	0	1	64	0	0	0	0	0	0	0	0	0	0	0	134	
11:30 AM	0	39	0	0	0	82	0	0	0	0	0	0	0	0	1	0	0	122	
11:35 AM	0	51	0	0	0	80	0	0	0	0	0	0	0	0	1	0	0	132	
11:40 AM	0	42	0	0	1	80	0	0	0	0	0	0	0	0	0	0	0	123	
11:45 AM	0	47	0	0	0	84	0	0	0	0	0	0	0	0	1	0	0	132	
11:50 AM	0	38	0	0	0	68	0	0	0	0	0	0	0	0	2	0	0	108	
11:55 AM	0	47	0	0	2	79	0	0	0	0	0	0	0	0	1	0	0	129	1526
12:00 PM	0	62	0	0	0	88	0	0	0	0	0	0	0	0	2	0	0	152	1564
12:05 PM	0	47	0	0	0	83	0	0	0	0	0	0	0	0	0	0	0	130	1555
12:10 PM	0	49	0	0	0	71	0	0	0	0	0	0	0	0	1	0	0	121	1542
12:15 PM	0	79	0	0	2	75	0	0	0	0	0	0	0	0	1	0	0	157	1581
12:20 PM	0	42	0	0	0	79	0	0	0	0	0	0	0	0	0	0	0	121	1561
12:25 PM	0	61	0	0	1	89	0	0	0	0	0	0	0	0	1	0	0	152	1579
12:30 PM	0	75	0	0	0	49	0	0	0	0	0	0	0	0	3	0	0	127	1584
12:35 PM	0	45	0	0	0	70	0	0	0	0	0	0	0	0	2	0	0	117	1569
12:40 PM	0	57	0	0	1	49	0	0	0	0	0	0	0	0	0	0	0	107	1553
12:45 PM	0	63	0	0	1	62	0	0	0	0	0	0	0	0	0	0	0	126	1547
12:50 PM	0	62	0	0	1	75	0	0	0	0	0	0	0	0	0	0	0	138	1577
12:55 PM	0	59	0	0	1	60	0	0	0	0	0	0	0	0	0	0	0	120	1568
Peak 15-Min Flowrates	Northbound				Southbound				Eastbound				Westbound				Total		
	Left	Thru	Right	U	Left	Thru	Right	U	Left	Thru	Right	U	Left	Thru	Right	U			
All Vehicles	0	728	0	0	12	972	0	0	0	0	0	0	0	0	8	0	0	1720	
Heavy Trucks	0	4	0	0	0	8	0	0	0	0	0	0	0	0	0	0	0	12	
Pedestrians	0	0	0	0	0	0	0	0	0	0	0	0	0	4	0	0	0	4	
Bicycles	0	0	0	0	0	0	0	0	0	0	0	0	0	0	0	0	0	0	
Railroad																			
Stopped Buses																			

Comments:

LOCATION: Carlos St -- Sierra St
CITY/STATE: San Mateo, CA

QC JOB #: 14384619
DATE: Thu, Apr 20 2017

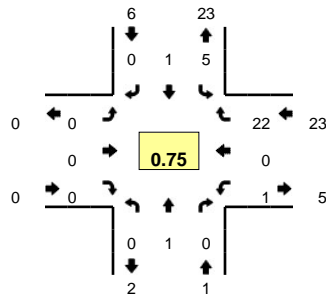

Peak-Hour: 7:45 AM -- 8:45 AM
Peak 15-Min: 8:15 AM -- 8:30 AM

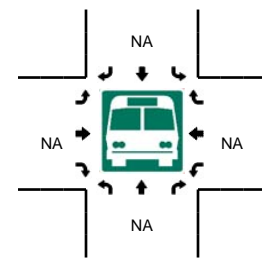
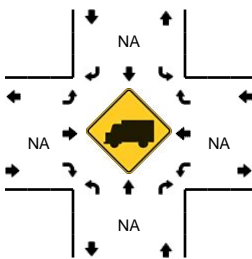
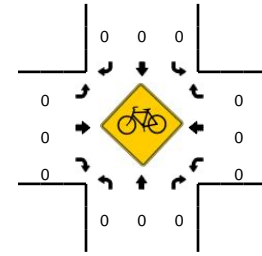
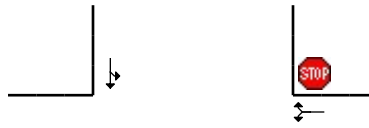
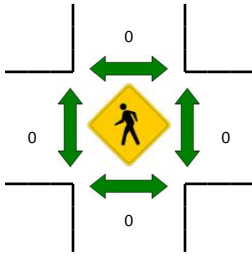
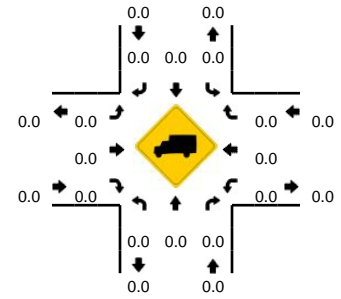

5-Min Count Period Beginning At	Carlos St (Northbound)				Carlos St (Southbound)				Sierra St (Eastbound)				Sierra St (Westbound)				Total	Hourly Totals	
	Left	Thru	Right	U	Left	Thru	Right	U	Left	Thru	Right	U	Left	Thru	Right	U			
7:00 AM	0	0	0	0	0	0	0	0	0	0	0	0	0	0	0	4	0	4	
7:05 AM	0	0	0	0	1	0	0	0	0	0	0	0	0	1	0	0	0	2	
7:10 AM	0	0	0	0	0	0	0	0	0	0	0	0	0	0	0	0	0	0	
7:15 AM	0	0	0	0	1	0	0	0	0	0	0	0	0	0	0	3	0	4	
7:20 AM	0	0	0	0	0	0	0	0	0	0	0	0	0	0	0	2	0	2	
7:25 AM	0	0	0	0	0	0	0	0	0	0	0	0	0	0	0	3	0	3	
7:30 AM	0	0	0	0	0	0	0	0	0	0	0	0	0	1	0	0	0	1	
7:35 AM	0	0	1	0	0	0	0	0	0	0	0	0	0	0	0	0	0	1	
7:40 AM	0	0	0	0	1	0	0	0	0	0	0	0	0	0	0	1	0	2	
7:45 AM	0	0	0	0	0	0	0	0	0	0	0	0	0	0	0	1	0	1	
7:50 AM	0	0	0	0	1	1	0	0	0	0	0	0	0	0	0	2	0	4	
7:55 AM	0	1	0	0	0	0	0	0	0	0	0	0	0	0	0	1	0	2	26
8:00 AM	0	0	0	0	0	0	0	0	0	0	0	0	0	0	0	1	0	1	23
8:05 AM	0	0	0	0	0	0	0	0	0	0	0	0	0	0	0	3	0	3	24
8:10 AM	0	0	0	0	0	0	0	0	0	0	0	0	0	0	0	3	0	3	27
8:15 AM	0	0	0	0	0	0	0	0	0	0	0	0	0	0	0	1	0	1	24
8:20 AM	0	0	0	0	1	0	0	0	0	0	0	0	0	1	0	2	0	4	26
8:25 AM	0	0	0	0	1	0	0	0	0	0	0	0	0	0	4	0	0	5	28
8:30 AM	0	0	0	0	0	0	0	0	0	0	0	0	0	0	0	1	0	1	28
8:35 AM	0	0	0	0	1	0	0	0	0	0	0	0	0	0	0	0	0	1	28
8:40 AM	0	0	0	0	1	0	0	0	0	0	0	0	0	0	0	3	0	4	30
8:45 AM	0	0	0	0	0	0	0	0	0	0	0	0	0	0	0	0	0	0	29
8:50 AM	0	0	0	0	0	0	0	0	0	0	0	0	0	0	0	0	0	0	25
8:55 AM	0	0	0	0	0	0	0	0	0	0	0	0	0	0	0	0	0	0	23
Peak 15-Min Flowrates	Northbound				Southbound				Eastbound				Westbound				Total		
	Left	Thru	Right	U	Left	Thru	Right	U	Left	Thru	Right	U	Left	Thru	Right	U			
All Vehicles	0	0	0	0	8	0	0	0	0	0	0	0	4	0	28	0	40		
Heavy Trucks	0	0	0	0	0	0	0	0	0	0	0	0	0	0	0	0	0		
Pedestrians	0	0	0	0	0	0	0	0	0	0	0	0	0	0	0	0	0		
Bicycles	0	0	0	0	0	0	0	0	0	0	0	0	0	0	0	0	0		
Railroad																			
Stopped Buses																			

Comments:

LOCATION: Carlos St -- Sierra St
CITY/STATE: San Mateo, CA

QC JOB #: 14384621
DATE: Sat, Apr 22 2017

Peak-Hour: 11:50 AM -- 12:50 PM
Peak 15-Min: 12:25 PM -- 12:40 PM

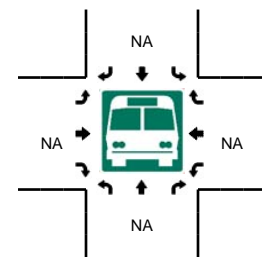
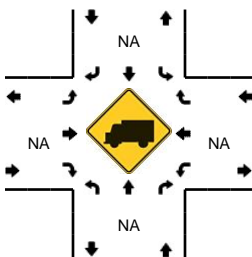
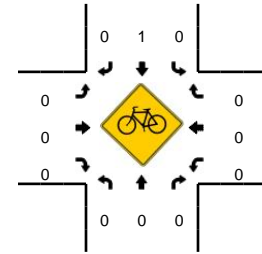
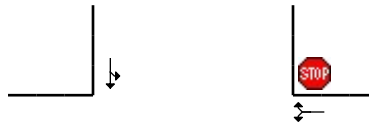
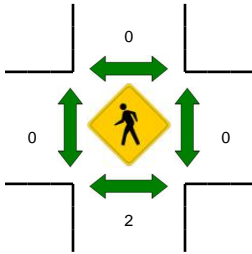
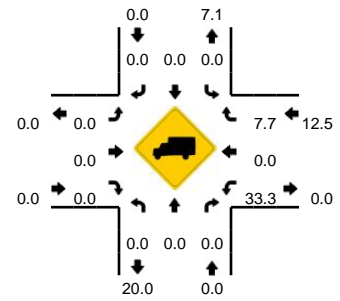
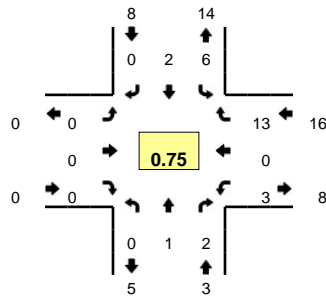

5-Min Count Period Beginning At	Carlos St (Northbound)				Carlos St (Southbound)				Sierra St (Eastbound)				Sierra St (Westbound)				Total	Hourly Totals		
	Left	Thru	Right	U	Left	Thru	Right	U	Left	Thru	Right	U	Left	Thru	Right	U				
11:00 AM	0	0	0	0	2	0	0	0	0	0	0	0	0	3	0	1	0	6		
11:05 AM	0	1	0	0	0	0	0	0	0	0	0	0	0	1	0	0	0	2		
11:10 AM	0	0	0	0	0	0	0	0	0	0	0	0	0	0	0	0	0	0		
11:15 AM	0	0	0	0	0	0	0	0	0	0	0	0	0	0	0	0	0	0		
11:20 AM	0	1	0	0	0	0	0	0	0	0	0	0	0	0	0	1	0	2		
11:25 AM	0	0	0	0	1	1	0	0	0	0	0	0	0	0	0	0	0	2		
11:30 AM	0	0	0	0	0	0	0	0	0	0	0	0	0	0	0	1	0	1		
11:35 AM	0	0	0	0	0	0	0	0	0	0	0	0	0	0	0	1	0	1		
11:40 AM	0	0	0	0	1	0	0	0	0	0	0	0	0	0	0	0	0	1		
11:45 AM	0	1	0	0	0	0	0	0	0	0	0	0	0	0	0	1	0	2		
11:50 AM	0	0	0	0	0	0	0	0	0	0	0	0	0	0	0	1	0	1		
11:55 AM	0	0	0	0	2	0	0	0	0	0	0	0	0	1	0	1	0	4	22	
12:00 PM	0	0	0	0	0	0	0	0	0	0	0	0	0	0	0	3	0	3	19	
12:05 PM	0	0	0	0	0	0	0	0	0	0	0	0	0	0	0	0	0	0	17	
12:10 PM	0	0	0	0	0	0	0	0	0	0	0	0	0	0	0	1	0	1	18	
12:15 PM	0	0	0	0	2	0	0	0	0	0	0	0	0	1	0	1	0	4	22	
12:20 PM	0	0	0	0	0	1	0	0	0	0	0	0	0	0	0	0	0	1	21	
12:25 PM	0	0	0	0	0	1	0	0	0	0	0	0	0	0	0	1	0	2	21	
12:30 PM	0	0	0	0	0	0	0	0	0	0	0	0	0	0	0	4	0	4	24	
12:35 PM	0	1	2	0	0	0	0	0	0	0	0	0	0	0	0	0	0	3	26	
12:40 PM	0	0	0	0	0	0	0	0	0	0	0	0	0	0	0	0	0	0	25	
12:45 PM	0	0	0	0	2	0	0	0	0	0	0	0	0	1	0	1	0	4	27	
12:50 PM	0	0	0	0	1	0	0	0	0	0	0	0	0	0	0	0	0	1	27	
12:55 PM	0	0	0	0	1	0	0	0	0	0	0	0	0	0	0	0	0	1	24	
Peak 15-Min Flowrates	Northbound				Southbound				Eastbound				Westbound				Total			
	Left	Thru	Right	U	Left	Thru	Right	U	Left	Thru	Right	U	Left	Thru	Right	U				
All Vehicles	0	4	8	0	0	4	0	0	0	0	0	0	0	0	0	20	0	36		
Heavy Trucks	0	0	0	0	0	0	0	0	0	0	0	0	0	0	0	0	0	0		
Pedestrians		4				0					0				0			4		
Bicycles	0	0	0		0	0	0			0	0	0		0	0	0		0		
Railroad																				
Stopped Buses																				

Comments:

LOCATION: Stetson St -- Sierra St
CITY/STATE: Moss Beach, CA

QC JOB #: 14384616
DATE: Thu, Apr 20 2017

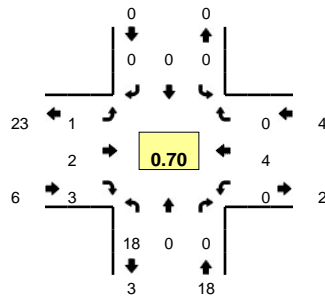

Peak-Hour: 7:45 AM -- 8:45 AM
Peak 15-Min: 8:15 AM -- 8:30 AM

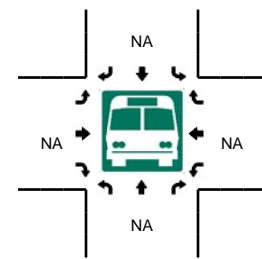
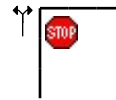
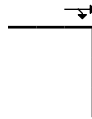
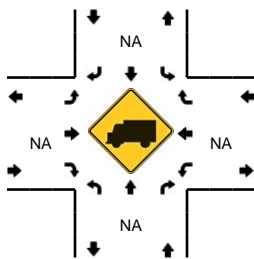
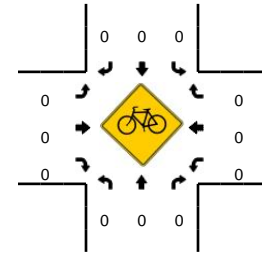
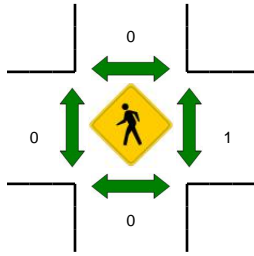
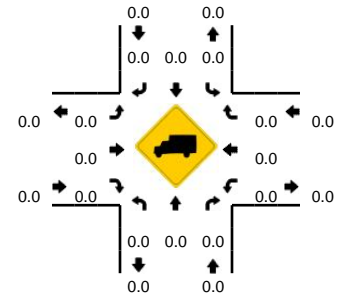

5-Min Count Period Beginning At	Stetson St (Northbound)				Stetson St (Southbound)				Sierra St (Eastbound)				Sierra St (Westbound)				Total	Hourly Totals	
	Left	Thru	Right	U	Left	Thru	Right	U	Left	Thru	Right	U	Left	Thru	Right	U			
7:00 AM	2	0	0	0	0	0	0	0	0	0	0	0	0	2	0	0	0	4	
7:05 AM	0	0	0	0	0	0	0	0	0	0	1	0	0	1	0	0	0	2	
7:10 AM	0	0	0	0	0	0	0	0	0	0	0	0	0	1	0	0	0	1	
7:15 AM	1	0	0	0	0	0	0	0	0	0	1	0	0	1	0	0	0	3	
7:20 AM	2	0	0	0	0	0	0	0	0	0	0	0	0	0	0	0	0	2	
7:25 AM	3	0	0	0	0	0	0	0	0	0	0	0	0	0	0	0	0	3	
7:30 AM	0	0	0	0	0	0	0	0	0	0	0	0	0	1	0	0	0	1	
7:35 AM	0	0	0	0	0	0	0	0	0	0	1	0	0	0	0	0	0	1	
7:40 AM	1	0	0	0	0	0	0	0	0	0	1	0	0	0	0	0	0	2	
7:45 AM	1	0	0	0	0	0	0	0	0	0	0	0	0	0	0	0	0	1	
7:50 AM	1	0	0	0	0	0	0	0	0	0	1	0	0	0	1	0	0	3	
7:55 AM	1	0	0	0	0	0	0	0	0	0	0	0	0	0	0	0	0	1	24
8:00 AM	1	0	0	0	0	0	0	0	0	0	0	0	0	0	0	0	0	1	21
8:05 AM	3	0	0	0	0	0	0	0	0	0	0	0	0	0	0	0	0	3	22
8:10 AM	1	0	0	0	0	0	0	0	0	0	0	0	0	2	0	0	0	3	24
8:15 AM	0	0	0	0	0	0	0	0	0	0	0	0	0	1	0	0	0	1	22
8:20 AM	2	0	0	0	0	0	0	0	0	0	1	0	1	0	0	0	0	4	24
8:25 AM	4	0	0	0	0	0	0	0	0	0	1	0	0	0	0	0	0	5	26
8:30 AM	1	0	0	0	0	0	0	0	0	0	0	0	0	0	0	0	0	1	26
8:35 AM	0	0	0	0	0	0	0	0	0	0	1	0	0	0	0	0	0	1	26
8:40 AM	3	0	0	0	0	0	0	0	0	0	1	0	0	0	0	0	0	4	28
8:45 AM	0	0	0	0	0	0	0	0	0	0	0	0	0	0	0	0	0	0	27
8:50 AM	0	0	0	0	0	0	0	0	0	0	0	0	0	0	0	0	0	0	24
8:55 AM	0	0	0	0	0	0	0	0	0	0	0	0	0	0	0	0	0	0	23
Peak 15-Min Flowrates	Northbound				Southbound				Eastbound				Westbound				Total		
	Left	Thru	Right	U	Left	Thru	Right	U	Left	Thru	Right	U	Left	Thru	Right	U			
All Vehicles	24	0	0	0	0	0	0	0	0	0	4	4	4	0	4	0	0	40	
Heavy Trucks	0	0	0	0	0	0	0	0	0	0	0	0	0	0	0	0	0	0	
Pedestrians	0	0	0	0	0	0	0	0	0	0	0	0	0	4	0	0	0	4	
Bicycles	0	0	0	0	0	0	0	0	0	0	0	0	0	0	0	0	0	0	
Railroad																			
Stopped Buses																			

Comments:

LOCATION: Stetson St -- Sierra St
CITY/STATE: Moss Beach, CA

QC JOB #: 14384617
DATE: Thu, Apr 20 2017

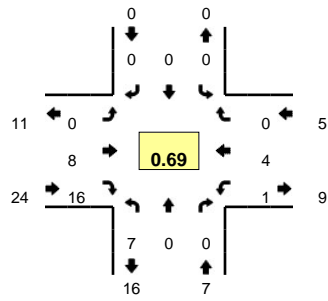

Peak-Hour: 5:00 PM -- 6:00 PM
Peak 15-Min: 5:45 PM -- 6:00 PM

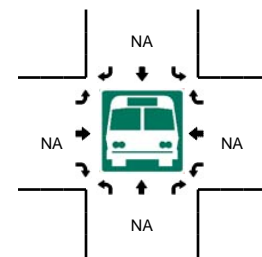
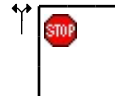
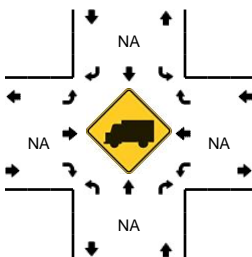
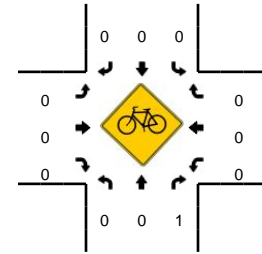
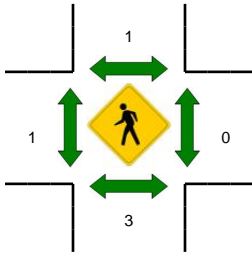
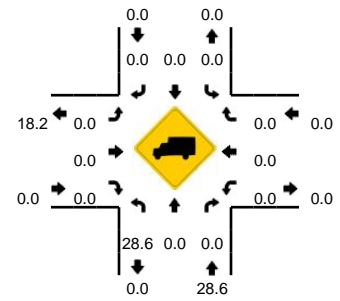

5-Min Count Period Beginning At	Stetson St (Northbound)				Stetson St (Southbound)				Sierra St (Eastbound)				Sierra St (Westbound)				Total	Hourly Totals
	Left	Thru	Right	U	Left	Thru	Right	U	Left	Thru	Right	U	Left	Thru	Right	U		
4:00 PM	0	0	0	0	0	0	0	0	0	0	0	0	0	1	0	0	1	
4:05 PM	0	0	0	0	0	0	0	0	0	1	1	0	0	1	0	0	3	
4:10 PM	0	0	0	0	0	0	0	0	0	0	0	0	0	0	0	0	0	
4:15 PM	0	0	0	0	0	0	0	0	0	0	1	0	0	0	0	0	1	
4:20 PM	2	0	0	0	0	0	0	0	0	0	0	0	0	0	0	0	2	
4:25 PM	0	0	0	0	0	0	0	0	0	0	0	0	0	0	0	0	0	
4:30 PM	1	0	0	0	0	0	0	0	0	1	1	0	0	0	0	0	3	
4:35 PM	0	0	0	0	0	0	0	0	0	0	1	0	0	0	0	0	1	
4:40 PM	0	0	0	0	0	0	0	0	0	1	1	0	0	0	0	0	2	
4:45 PM	0	0	0	0	0	0	0	0	0	0	2	0	0	0	0	0	2	
4:50 PM	0	0	0	0	0	0	0	0	0	1	2	0	0	0	0	0	3	
4:55 PM	0	0	0	0	0	0	0	0	0	0	0	0	0	1	0	0	1	19
5:00 PM	0	0	0	0	0	0	0	0	0	2	1	0	0	1	0	0	4	22
5:05 PM	0	0	0	0	0	0	0	0	0	0	3	0	0	0	0	0	3	22
5:10 PM	1	0	0	0	0	0	0	0	0	0	0	0	0	1	0	0	2	24
5:15 PM	0	0	0	0	0	0	0	0	0	1	2	0	0	1	0	0	4	27
5:20 PM	1	0	0	0	0	0	0	0	0	1	0	0	0	1	0	0	3	28
5:25 PM	0	0	0	0	0	0	0	0	0	0	3	0	0	0	0	0	3	31
5:30 PM	0	0	0	0	0	0	0	0	0	0	1	0	0	0	0	0	1	29
5:35 PM	1	0	0	0	0	0	0	0	0	1	0	0	0	0	0	0	2	30
5:40 PM	0	0	0	0	0	0	0	0	0	0	0	0	0	0	0	1	1	29
5:45 PM	2	0	0	0	0	0	0	0	0	2	2	0	0	0	0	0	6	33
5:50 PM	2	0	0	0	0	0	0	0	0	1	2	0	0	0	0	0	5	35
5:55 PM	0	0	0	0	0	0	0	0	0	0	2	0	0	0	0	0	2	36
Peak 15-Min Flowrates	Northbound				Southbound				Eastbound				Westbound				Total	
All Vehicles	16	0	0	0	0	0	0	0	0	12	24	0	0	0	0	0	52	
Heavy Trucks	8	0	0	0	0	0	0	0	0	0	0	0	0	0	0	0	8	
Pedestrians	0	0	0	0	0	0	0	0	0	0	0	0	0	0	0	0	0	
Bicycles	0	0	0	0	0	0	0	0	0	0	0	0	0	0	0	0	0	
Railroad																		
Stopped Buses																		

Comments:

LOCATION: Stetson St -- Sierra St
CITY/STATE: Moss Beach, CA

QC JOB #: 14384618
DATE: Sat, Apr 22 2017

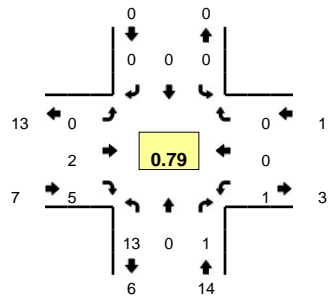

Peak-Hour: 11:40 AM -- 12:40 PM
Peak 15-Min: 11:50 AM -- 12:05 PM

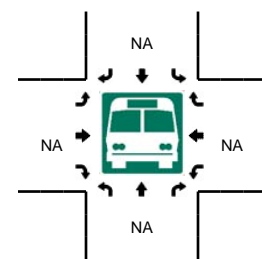
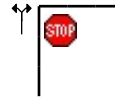
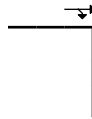
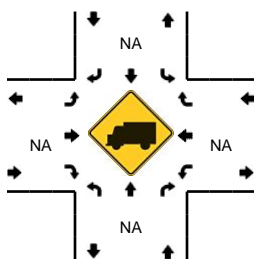
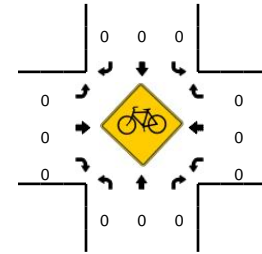
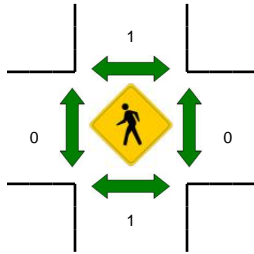
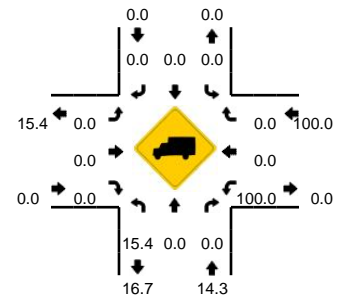

5-Min Count Period Beginning At	Stetson St (Northbound)				Stetson St (Southbound)				Sierra St (Eastbound)				Sierra St (Westbound)				Total	Hourly Totals	
	Left	Thru	Right	U	Left	Thru	Right	U	Left	Thru	Right	U	Left	Thru	Right	U			
11:00 AM	1	0	0	0	0	0	0	0	0	0	2	0	0	0	0	0	0	3	
11:05 AM	0	0	0	0	0	0	0	0	0	0	0	0	0	0	0	1	0	1	
11:10 AM	0	0	0	0	0	0	0	0	0	0	0	0	0	0	0	0	0	0	
11:15 AM	0	0	0	0	0	0	0	0	0	0	0	0	0	0	0	0	0	0	
11:20 AM	1	0	0	0	0	0	0	0	0	0	0	0	0	0	0	0	0	1	
11:25 AM	1	0	0	0	0	0	0	0	0	0	0	1	0	0	0	0	0	2	
11:30 AM	0	0	0	0	0	0	0	0	0	0	0	0	0	0	0	0	0	0	
11:35 AM	1	0	0	0	0	0	0	0	0	0	0	0	0	0	0	0	0	1	
11:40 AM	0	0	0	0	0	0	0	0	0	0	0	1	0	0	0	0	0	1	
11:45 AM	1	0	0	0	0	0	0	0	0	0	0	0	0	0	0	0	0	1	
11:50 AM	1	0	0	0	0	0	0	0	0	0	0	0	0	0	0	0	0	1	
11:55 AM	1	0	1	0	0	0	0	0	0	0	0	2	0	0	0	0	0	4	15
12:00 PM	2	0	0	0	0	0	0	0	0	0	0	0	0	0	0	0	0	2	14
12:05 PM	0	0	0	0	0	0	0	0	0	0	0	0	0	1	0	0	0	1	14
12:10 PM	1	0	0	0	0	0	0	0	0	0	0	0	0	0	0	0	0	1	15
12:15 PM	2	0	0	0	0	0	0	0	0	0	0	2	0	0	0	0	0	4	19
12:20 PM	0	0	0	0	0	0	0	0	0	0	0	0	0	0	0	0	0	0	18
12:25 PM	2	0	0	0	0	0	0	0	0	0	0	0	0	0	0	0	0	2	18
12:30 PM	3	0	0	0	0	0	0	0	0	0	0	0	0	0	0	0	0	3	21
12:35 PM	0	0	0	0	0	0	0	0	0	0	2	0	0	0	0	0	0	2	22
12:40 PM	0	0	0	0	0	0	0	0	0	0	0	0	0	0	0	0	0	0	21
12:45 PM	0	0	0	0	0	0	0	0	0	0	0	2	0	0	0	0	0	2	22
12:50 PM	0	0	0	0	0	0	0	0	0	0	0	1	0	0	0	0	0	1	22
12:55 PM	0	0	0	0	0	0	0	0	0	0	0	1	0	0	0	0	0	1	19
Peak 15-Min Flowrates	Northbound				Southbound				Eastbound				Westbound				Total		
	Left	Thru	Right	U	Left	Thru	Right	U	Left	Thru	Right	U	Left	Thru	Right	U			
All Vehicles	16	0	4	0	0	0	0	0	0	0	0	8	0	0	0	0	0	28	
Heavy Trucks	4	0	0	0	0	0	0	0	0	0	0	0	0	0	0	0	0	4	
Pedestrians	0	0	0	0	0	0	0	0	0	0	0	0	0	0	0	0	0	0	
Bicycles	0	0	0	0	0	0	0	0	0	0	0	0	0	0	0	0	0	0	
Railroad																			
Stopped Buses																			

Comments:

LOCATION: Cabrillo Hwy (Hwy 1) -- Vallemar St/Etheldore St
CITY/STATE: San Mateo, CA

QC JOB #: 14384628
DATE: Thu, Apr 20 2017

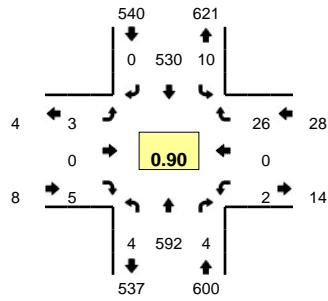

Peak-Hour: 7:45 AM -- 8:45 AM
Peak 15-Min: 8:10 AM -- 8:25 AM

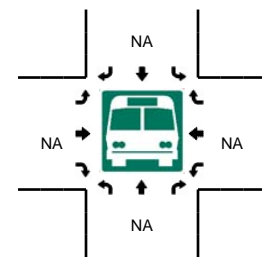
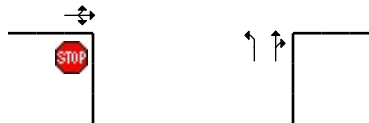
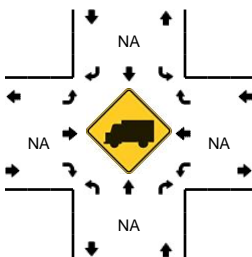
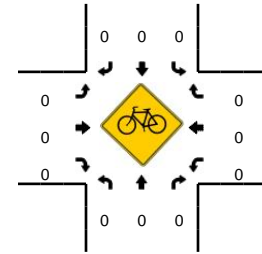
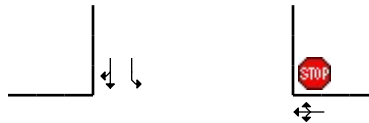
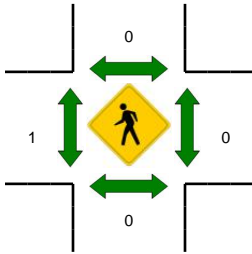
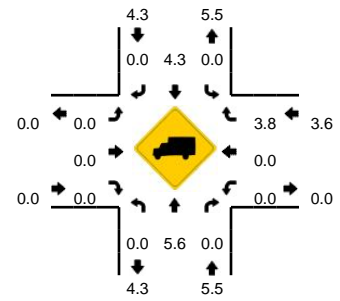

5-Min Count Period Beginning At	Cabrillo Hwy (Hwy 1) (Northbound)				Cabrillo Hwy (Hwy 1) (Southbound)				Vallemar St/Etheldore St (Eastbound)				Vallemar St/Etheldore St (Westbound)				Total	Hourly Totals
	Left	Thru	Right	U	Left	Thru	Right	U	Left	Thru	Right	U	Left	Thru	Right	U		
7:00 AM	1	49	0	0	1	21	1	0	0	0	1	0	0	0	4	0	78	
7:05 AM	0	53	0	0	0	25	0	0	0	0	1	0	0	0	2	0	81	
7:10 AM	0	44	0	0	0	30	0	0	0	0	0	0	2	0	0	0	76	
7:15 AM	0	49	1	0	1	25	0	0	0	0	0	0	0	0	5	0	81	
7:20 AM	0	55	0	0	0	29	0	0	3	0	0	0	1	0	4	0	92	
7:25 AM	0	42	0	0	0	24	0	0	0	0	1	0	0	0	2	0	69	
7:30 AM	0	50	0	0	2	27	1	0	1	0	2	0	1	0	2	0	86	
7:35 AM	0	48	0	0	0	29	0	0	0	0	1	0	0	0	3	0	81	
7:40 AM	1	52	0	0	0	43	0	0	1	0	0	0	0	0	4	0	101	
7:45 AM	0	53	2	0	0	50	0	0	2	0	0	0	0	0	2	0	109	
7:50 AM	0	51	0	0	1	47	0	0	0	0	0	0	0	0	2	0	101	
7:55 AM	0	43	1	0	1	41	0	0	0	0	1	0	0	0	2	0	89	1044
8:00 AM	0	49	0	0	0	26	0	0	0	0	0	0	0	0	1	0	76	1042
8:05 AM	0	40	0	0	1	34	0	0	0	0	1	0	0	0	0	0	76	1037
8:10 AM	1	51	0	0	2	43	0	0	0	0	0	0	1	0	4	0	102	1063
8:15 AM	1	58	0	0	2	46	0	0	0	0	0	0	0	0	5	0	112	1094
8:20 AM	1	68	0	0	2	38	0	0	1	0	0	0	0	0	3	0	113	1115
8:25 AM	0	49	1	0	0	41	0	0	0	0	1	0	1	0	1	0	94	1140
8:30 AM	0	34	0	0	1	46	0	0	0	0	0	0	0	0	1	0	82	1136
8:35 AM	0	48	0	0	0	65	0	0	0	0	2	0	0	0	1	0	116	1171
8:40 AM	1	48	0	0	0	53	0	0	0	0	0	0	0	0	4	0	106	1176
8:45 AM	0	31	0	0	1	43	0	0	1	0	1	0	0	0	1	0	78	1145
8:50 AM	0	43	0	0	1	34	1	0	0	0	0	0	0	0	1	0	80	1124
8:55 AM	0	32	0	0	0	44	0	0	0	0	1	0	0	0	3	0	80	1115
Peak 15-Min Flowrates	Northbound				Southbound				Eastbound				Westbound				Total	
	Left	Thru	Right	U	Left	Thru	Right	U	Left	Thru	Right	U	Left	Thru	Right	U		
All Vehicles	12	708	0	0	24	508	0	0	4	0	0	0	4	0	48	0	1308	
Heavy Trucks	0	40	0	0	0	12	0	0	0	0	0	0	0	0	0	0	52	
Pedestrians	0	0	0	0	0	0	0	0	0	0	0	0	0	0	0	0	0	
Bicycles	0	0	0	0	0	0	0	0	0	0	0	0	0	0	0	0	0	
Railroad																		
Stopped Buses																		

Comments:

LOCATION: Cabrillo Hwy (Hwy 1) -- Vallemar St/Etheldore St
CITY/STATE: San Mateo, CA

QC JOB #: 14384629
DATE: Thu, Apr 20 2017

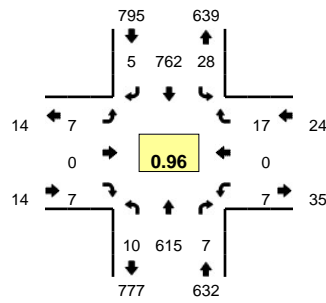

Peak-Hour: 4:45 PM -- 5:45 PM
Peak 15-Min: 4:50 PM -- 5:05 PM

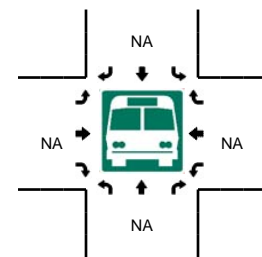
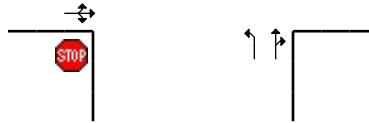
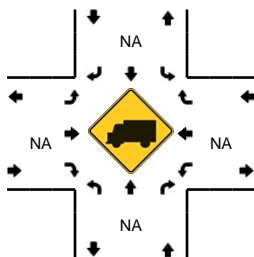
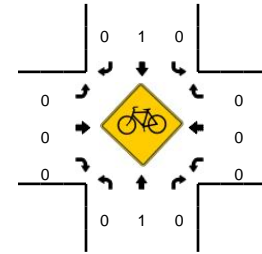
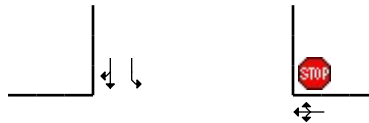
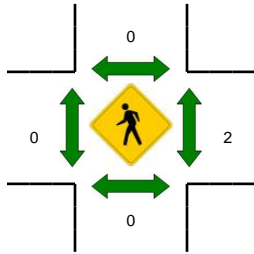
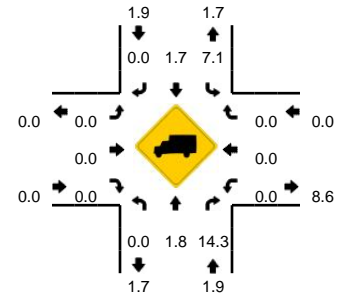

5-Min Count Period Beginning At	Cabrillo Hwy (Hwy 1) (Northbound)				Cabrillo Hwy (Hwy 1) (Southbound)				Vallemar St/Etheldore St (Eastbound)				Vallemar St/Etheldore St (Westbound)				Total	Hourly Totals
	Left	Thru	Right	U	Left	Thru	Right	U	Left	Thru	Right	U	Left	Thru	Right	U		
4:00 PM	0	20	0	0	0	30	0	0	0	0	0	0	0	0	0	0	50	
4:05 PM	1	53	0	0	3	67	0	0	0	0	0	0	0	0	1	0	125	
4:10 PM	1	50	1	0	2	53	0	0	0	0	0	0	0	2	0	0	109	
4:15 PM	0	53	1	0	2	62	0	0	0	0	0	0	0	2	0	0	120	
4:20 PM	0	56	1	0	0	54	0	0	0	0	1	0	1	0	0	0	113	
4:25 PM	0	54	2	0	4	65	1	0	0	0	0	0	0	1	0	0	127	
4:30 PM	0	50	2	0	1	45	1	0	0	0	0	0	0	1	1	0	101	
4:35 PM	0	52	0	0	1	57	1	0	0	0	2	0	0	0	1	0	114	
4:40 PM	0	44	1	0	2	66	0	0	0	0	0	0	0	0	0	0	113	
4:45 PM	2	51	0	0	4	62	0	0	0	0	1	0	1	0	2	0	123	
4:50 PM	1	47	1	0	3	56	1	0	0	0	1	0	1	0	2	0	113	
4:55 PM	2	44	1	1	4	75	0	0	1	0	0	0	1	0	2	0	131	1339
5:00 PM	1	62	0	0	0	69	0	0	0	0	1	0	0	0	6	0	139	1428
5:05 PM	0	53	2	0	1	51	1	0	0	0	0	0	0	0	0	0	108	1411
5:10 PM	0	47	1	0	2	68	0	0	0	0	1	0	0	0	0	0	119	1421
5:15 PM	1	52	0	0	5	61	0	0	2	0	1	0	1	0	1	0	124	1425
5:20 PM	1	51	0	0	1	52	1	0	2	0	0	0	1	0	1	0	110	1422
5:25 PM	0	49	0	0	4	78	1	0	0	0	1	0	1	0	1	0	135	1430
5:30 PM	1	49	0	0	2	55	0	0	0	0	0	0	0	0	0	0	107	1436
5:35 PM	0	58	2	0	1	73	0	0	1	0	1	0	1	0	1	0	138	1460
5:40 PM	0	52	0	0	1	62	1	0	1	0	0	0	0	0	1	0	118	1465
5:45 PM	0	37	1	0	3	45	0	0	0	0	0	0	0	0	2	0	88	1430
5:50 PM	0	49	0	0	4	53	0	0	1	0	0	0	0	0	2	0	109	1426
5:55 PM	0	62	0	0	2	71	0	0	0	0	0	0	0	0	0	0	135	1430
Peak 15-Min Flowrates	Northbound				Southbound				Eastbound				Westbound				Total	
	Left	Thru	Right	U	Left	Thru	Right	U	Left	Thru	Right	U	Left	Thru	Right	U		
All Vehicles	16	612	8	4	28	800	4	0	4	0	8	0	8	0	40	0	1532	
Heavy Trucks	0	24	0	0	0	12	0	0	0	0	0	0	0	0	0	0	36	
Pedestrians	0	0	0	0	0	0	0	0	0	0	0	0	0	0	0	0	0	
Bicycles	0	0	0	0	0	0	0	0	0	0	0	0	0	0	0	0	0	
Railroad																		
Stopped Buses																		

Comments:

LOCATION: Cabrillo Hwy(Hwy 1) -- Vallemar St/Etheldore St
CITY/STATE: San Mateo, CA

QC JOB #: 14384630
DATE: Sat, Apr 22 2017

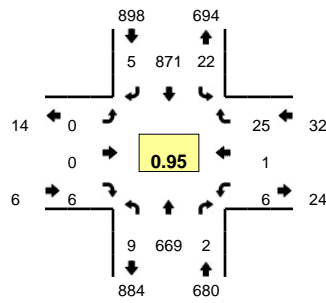

Peak-Hour: 11:55 AM -- 12:55 PM
Peak 15-Min: 12:15 PM -- 12:30 PM

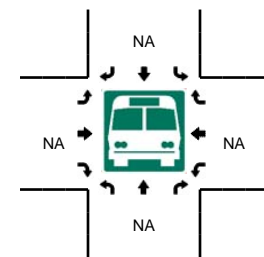
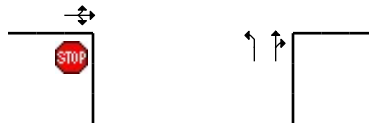
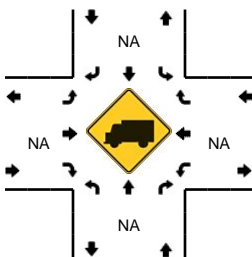
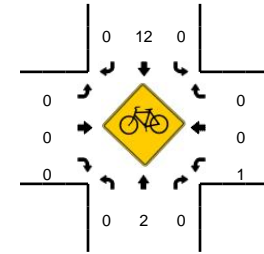
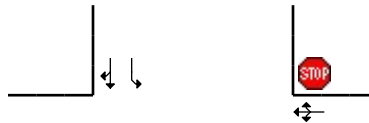
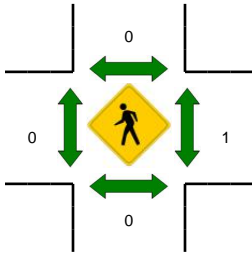
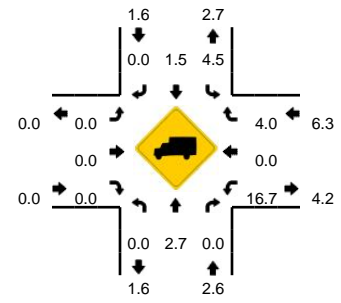

5-Min Count Period Beginning At	Cabrillo Hwy(Hwy 1) (Northbound)				Cabrillo Hwy(Hwy 1) (Southbound)				Vallemar St/Etheldore St (Eastbound)				Vallemar St/Etheldore St (Westbound)				Total	Hourly Totals
	Left	Thru	Right	U	Left	Thru	Right	U	Left	Thru	Right	U	Left	Thru	Right	U		
11:00 AM	1	50	0	0	2	58	2	0	0	0	2	0	1	1	1	0	118	
11:05 AM	0	59	0	0	0	80	0	0	0	0	0	0	2	0	3	0	144	
11:10 AM	0	51	0	0	2	73	0	0	0	0	0	0	2	0	2	0	130	
11:15 AM	0	56	1	0	0	63	0	0	0	0	1	0	1	0	3	0	125	
11:20 AM	1	47	0	0	2	83	0	0	0	0	0	0	0	0	2	0	135	
11:25 AM	1	65	0	0	2	61	0	0	2	0	0	0	1	0	3	0	135	
11:30 AM	1	38	0	0	3	77	1	0	0	0	1	0	1	0	2	0	124	
11:35 AM	0	52	0	0	1	78	0	0	0	0	0	0	0	0	0	0	131	
11:40 AM	0	39	3	0	1	74	0	0	0	0	1	0	0	0	1	0	119	
11:45 AM	0	39	0	0	2	81	0	0	0	0	0	0	0	0	5	0	127	
11:50 AM	0	39	1	0	3	69	0	0	0	1	0	0	0	0	2	0	115	
11:55 AM	0	46	0	0	3	74	0	0	0	0	0	0	1	0	2	0	126	1529
12:00 PM	1	64	0	0	2	88	0	0	0	0	0	0	1	0	2	0	158	1569
12:05 PM	1	41	0	0	2	81	0	0	0	0	0	0	1	0	2	0	128	1553
12:10 PM	1	64	0	0	3	64	0	0	0	0	1	0	0	0	2	0	135	1558
12:15 PM	0	56	1	0	1	76	1	0	0	0	0	0	0	0	2	0	137	1570
12:20 PM	2	59	0	0	1	77	0	0	0	0	1	0	1	0	3	0	144	1579
12:25 PM	1	50	0	1	2	89	0	0	0	0	1	0	0	0	0	0	144	1588
12:30 PM	0	68	0	0	0	47	0	0	0	0	0	0	0	0	2	0	117	1581
12:35 PM	0	48	0	0	1	68	0	0	0	0	0	0	0	0	2	0	119	1569
12:40 PM	0	49	0	0	2	76	3	0	0	0	0	0	1	0	2	0	133	1583
12:45 PM	2	67	0	0	0	61	0	0	0	0	2	0	1	0	2	0	135	1591
12:50 PM	0	57	1	0	5	70	1	0	0	0	1	0	0	1	4	0	140	1616
12:55 PM	0	55	0	0	0	57	0	0	0	0	1	0	0	1	0	0	114	1604
Peak 15-Min Flowrates	Northbound				Southbound				Eastbound				Westbound				Total	
	Left	Thru	Right	U	Left	Thru	Right	U	Left	Thru	Right	U	Left	Thru	Right	U		
All Vehicles	12	660	4	4	16	968	4	0	0	0	8	0	4	0	20	0	1700	
Heavy Trucks	0	24	0	0	0	16	0	0	0	0	0	0	4	0	0	0	44	
Pedestrians		0				0					0				0		0	
Bicycles	0	1	0		0	0	0		0	0	0		0	0	0		1	
Railroad																		
Stopped Buses																		

Comments:



Location: California Ave & Cabrillo Hwy

Date: 4/20/2017

Site Code: 14384625

Location:	Cabrillo Hwy (Hwy 1) Southbound					California Ave Westbound					Cabrillo Hwy (Hwy 1) Northbound					California Ave Eastbound					Wienke Way Southeastbound				
	Right to Wienke Way	Right	Thru	Left	U-Turn	Right	Thru to Wienke Way	Thru	Left	U-Turn	Right	Thru	Left to Wienke Way	Left	U-Turn	Right	Thru	Left	Left to Wienke Way	U-Turn	Right to California Ave	Right to Cabrillo Hwy (Hwy 1)	Thru to California Ave	Left to Cabrillo Hwy (Hwy 1)	U-Turn
7:00 AM	0	0	23	0	0	3	0	0	2	0	0	49	0	0	0	0	0	0	0	0	0	0	0	0	0
7:05 AM	0	0	26	0	0	4	0	0	2	0	0	47	0	0	0	0	0	1	0	0	0	1	0	0	0
7:10 AM	0	0	32	0	0	1	0	0	5	0	1	42	1	0	0	2	0	0	0	0	0	0	0	1	0
7:15 AM	0	0	26	0	0	0	0	0	3	0	0	49	0	0	0	0	0	0	0	0	0	3	0	0	0
7:20 AM	0	0	26	0	0	1	0	0	3	0	0	55	0	1	0	0	0	0	0	0	0	0	0	0	0
7:25 AM	0	0	28	0	0	1	0	0	5	0	0	43	0	0	0	1	0	0	0	0	0	1	0	0	0
7:30 AM	0	0	29	0	0	1	0	0	8	0	3	46	0	0	0	1	0	2	0	0	0	2	0	0	0
7:35 AM	0	0	31	1	0	1	0	0	3	0	1	47	1	0	0	0	0	0	0	0	0	0	0	0	0
7:40 AM	0	0	43	0	0	4	0	0	6	0	0	50	1	1	0	0	0	0	0	0	0	0	1	0	0
7:45 AM	0	0	45	2	0	0	0	0	6	0	2	52	1	0	0	0	0	0	0	0	0	1	0	0	0
7:50 AM	0	0	45	1	0	1	0	0	4	0	1	54	0	0	0	1	0	0	0	0	0	1	0	0	0
7:55 AM	0	1	42	0	0	2	0	0	3	0	2	41	1	0	0	0	1	0	0	0	0	2	0	0	0
8:00 AM	0	0	28	0	0	1	0	0	4	0	1	48	1	0	0	1	0	0	0	0	0	0	0	0	0
8:05 AM	0	0	34	0	0	0	0	0	3	0	1	35	1	0	0	1	0	2	0	0	0	0	0	1	0
8:10 AM	0	0	43	0	0	1	0	0	6	0	4	50	0	1	0	2	0	1	0	0	0	0	0	0	0
8:15 AM	0	0	45	1	0	2	0	0	4	0	1	59	0	0	0	1	0	0	0	0	1	0	0	0	0
8:20 AM	0	0	34	0	0	1	0	0	1	0	0	67	2	1	0	1	0	2	0	0	0	1	0	0	0
8:25 AM	0	1	45	1	0	2	0	0	5	0	1	45	1	0	0	1	0	1	0	0	0	0	0	1	0
8:30 AM	0	0	46	0	0	2	0	0	3	0	1	32	0	0	0	0	0	0	0	0	0	0	0	1	0
8:35 AM	0	0	60	1	0	2	0	0	4	0	3	46	0	2	0	2	0	2	0	0	0	0	0	0	0
8:40 AM	0	3	54	0	0	1	0	0	5	0	4	45	0	0	0	1	0	1	0	0	0	0	0	0	0
8:45 AM	0	0	44	0	0	0	0	0	4	0	1	33	1	1	0	2	0	0	0	0	0	2	0	0	0
8:50 AM	0	1	35	1	0	1	0	0	4	0	0	40	2	1	0	2	0	0	0	0	0	0	0	2	0
8:55 AM	0	0	42	2	0	1	0	0	5	0	2	31	0	0	0	1	0	0	0	0	0	0	0	0	0
Total	0	6	906	10	0	33	0	0	98	0	29	1106	13	8	0	20	0	13	0	0	1	14	1	6	0

Peak Hour: 7:45 AM - 8:45 AM

Peak 15: 8:30 AM - 8:45 AM

PHF: 0.929348



Location: California Ave & Cabrillo Hwy

Date: 4/20/2017

Site Code: 14384625

Location:	Cabrillo Hwy (Hwy 1) Southbound					California Ave Westbound					Cabrillo Hwy (Hwy 1) Northbound					California Ave Eastbound					Wienke Way Southeastbound				
	Right to Wienke Way	Right	Thru	Left	U-Turn	Right	Thru to Wienke Way	Thru	Left	U-Turn	Right	Thru	Left to Wienke Way	Left	U-Turn	Right	Thru	Left	Left to Wienke Way	U-Turn	Right to California Ave	Right to Cabrillo Hwy (Hwy 1)	Thru to California Ave	Left to Cabrillo Hwy (Hwy 1)	U-Turn
7:00 AM	0	0	20	0	0	3	0	0	2	0	0	47	0	0	0	0	0	0	0	0	0	0	0	0	0
7:05 AM	0	0	24	0	0	4	0	0	2	0	0	45	0	0	0	0	0	1	0	0	0	0	1	0	0
7:10 AM	0	0	32	0	0	1	0	0	5	0	1	39	1	0	0	2	0	0	0	0	0	0	0	1	0
7:15 AM	0	0	24	0	0	0	0	0	3	0	0	49	0	0	0	0	0	0	0	0	0	0	3	0	0
7:20 AM	0	0	25	0	0	1	0	0	3	0	0	51	0	1	0	0	0	0	0	0	0	0	0	0	0
7:25 AM	0	0	27	0	0	1	0	0	5	0	0	42	0	0	0	1	0	0	0	0	0	0	1	0	0
7:30 AM	0	0	28	0	0	1	0	0	8	0	3	45	0	0	0	1	0	2	0	0	0	0	2	0	0
7:35 AM	0	0	30	1	0	1	0	0	3	0	1	42	1	0	0	0	0	0	0	0	0	0	0	0	0
7:40 AM	0	0	43	0	0	3	0	0	6	0	0	49	1	1	0	0	0	0	0	0	0	0	1	0	0
7:45 AM	0	0	43	2	0	0	0	0	6	0	2	46	1	0	0	0	0	0	0	0	0	0	1	0	0
7:50 AM	0	0	45	1	0	1	0	0	4	0	1	47	0	0	0	1	0	0	0	0	0	0	1	0	0
7:55 AM	0	1	41	0	0	2	0	0	3	0	2	37	1	0	0	0	0	1	0	0	0	0	2	0	0
8:00 AM	0	0	28	0	0	1	0	0	4	0	1	45	1	0	0	1	0	0	0	0	0	0	0	0	0
8:05 AM	0	0	34	0	0	0	0	0	3	0	1	30	1	0	0	1	0	2	0	0	0	0	0	1	0
8:10 AM	0	0	43	0	0	1	0	0	6	0	4	45	0	1	0	2	0	1	0	0	0	0	0	0	0
8:15 AM	0	0	43	1	0	2	0	0	4	0	1	56	0	0	0	1	0	0	0	0	0	1	0	0	0
8:20 AM	0	0	34	0	0	1	0	0	1	0	0	61	2	1	0	1	0	2	0	0	0	0	1	0	0
8:25 AM	0	1	40	1	0	2	0	0	5	0	1	42	1	0	0	1	0	1	0	0	0	0	0	1	0
8:30 AM	0	0	40	0	0	2	0	0	3	0	1	31	0	0	0	0	0	0	0	0	0	0	0	1	0
8:35 AM	0	0	57	1	0	2	0	0	4	0	3	45	0	2	0	2	0	2	0	0	0	0	0	0	0
8:40 AM	0	3	52	0	0	1	0	0	5	0	4	43	0	0	0	1	0	1	0	0	0	0	0	0	0
8:45 AM	0	0	42	0	0	0	0	0	4	0	1	31	1	1	0	2	0	0	0	0	0	2	0	0	0
8:50 AM	0	1	32	1	0	1	0	0	4	0	0	40	2	1	0	2	0	0	0	0	0	0	0	2	0
8:55 AM	0	0	41	2	0	1	0	0	5	0	2	29	0	0	0	1	0	0	0	0	0	0	0	0	0
Total	0	6	868	10	0	32	0	0	98	0	29	1037	13	8	0	20	0	13	0	0	1	14	1	6	0



Location: California Ave & Cabrillo Hwy

Date: 4/20/2017

Site Code: 14384625

Location:	Cabrillo Hwy (Hwy 1) Southbound					California Ave Westbound					Cabrillo Hwy (Hwy 1) Northbound					California Ave Eastbound					Wienke Way Southeastbound				
	Right to Wienke Way	Right	Thru	Left	Peds	Right	Thru to Wienke Way	Thru	Left	Peds	Right	Thru	Left to Wienke Way	Left	Peds	Right	Thru	Left	Left to Wienke Way	Peds	Right to California Ave	Right to Cabrillo Hwy (Hwy 1)	Thru to California Ave	Left to Cabrillo Hwy (Hwy 1)	Peds
7:00 AM	0	0	0	0	0	0	0	0	0	0	0	0	0	0	0	0	0	0	0	0	0	0	0	0	0
7:05 AM	0	0	0	0	0	0	0	0	0	0	0	0	0	0	0	0	0	0	1	0	0	0	0	0	0
7:10 AM	0	0	0	0	0	0	0	0	0	0	0	0	0	0	0	2	0	0	0	0	0	0	0	0	0
7:15 AM	0	0	0	0	0	0	0	0	0	0	0	0	0	0	1	0	0	0	0	0	0	0	0	0	0
7:20 AM	0	0	0	0	0	0	0	0	0	0	0	0	0	0	0	0	0	0	0	0	0	0	0	0	0
7:25 AM	0	0	0	0	0	0	0	0	0	0	0	0	0	0	0	1	0	0	0	0	0	0	0	0	0
7:30 AM	0	0	0	0	0	0	0	0	0	0	0	0	0	0	0	1	0	2	0	0	0	0	0	0	0
7:35 AM	0	0	0	0	0	0	0	0	0	0	0	0	0	0	0	0	0	0	0	0	0	0	0	0	0
7:40 AM	0	0	0	0	0	0	0	0	0	0	0	0	0	0	0	0	0	0	0	0	0	0	0	0	0
7:45 AM	0	0	0	0	0	0	0	0	0	0	0	0	0	0	0	0	0	0	0	0	0	0	0	0	0
7:50 AM	0	0	0	0	0	0	0	0	0	0	0	0	0	0	0	1	0	0	0	0	0	0	0	0	0
7:55 AM	0	0	0	0	0	0	0	0	0	0	0	0	0	0	0	0	0	1	0	1	0	1	0	0	1
8:00 AM	0	0	0	0	0	0	0	0	0	0	0	0	0	0	0	1	0	0	0	0	0	0	0	0	0
8:05 AM	0	0	0	0	0	0	0	0	0	0	0	0	0	0	0	1	0	2	0	0	0	0	0	0	0
8:10 AM	0	0	0	0	0	0	0	0	0	0	0	0	0	0	0	2	0	1	0	0	0	0	0	0	0
8:15 AM	0	0	0	0	0	0	0	0	0	0	0	0	0	0	0	1	0	0	0	0	0	0	0	0	0
8:20 AM	0	0	0	0	0	0	0	0	0	0	0	0	0	0	0	1	0	2	0	0	0	0	0	0	0
8:25 AM	0	0	0	0	0	0	0	0	0	0	0	0	0	0	0	1	0	1	0	0	0	0	0	0	0
8:30 AM	0	0	0	0	0	0	0	0	0	0	0	0	0	0	0	0	0	0	0	0	0	0	0	0	0
8:35 AM	0	0	0	0	0	0	0	0	0	0	0	0	0	0	0	2	0	2	0	0	0	0	0	0	0
8:40 AM	0	0	0	0	0	0	0	0	0	0	0	0	0	0	0	1	0	1	0	0	0	0	0	0	0
8:45 AM	0	0	0	0	0	0	0	0	0	0	0	0	0	0	0	2	0	0	0	0	0	0	0	0	0
8:50 AM	0	0	1	0	0	0	0	0	0	0	0	0	0	0	0	2	0	0	0	0	0	0	0	0	0
8:55 AM	0	0	0	0	1	0	0	0	0	0	0	0	0	0	0	1	0	0	0	0	0	0	0	0	0
Total	0	0	1	0	1	0	0	0	0	0	0	0	0	0	1	20	0	13	0	1	0	0	0	0	1



Location: California Ave & Cabrillo Hwy

Date: 4/20/2017

Site Code: 14384626

Location:	Cabrillo Hwy (Hwy 1) Southbound					California Ave Westbound					Cabrillo Hwy (Hwy 1) Northbound					California Ave Eastbound					Wienke Way Southeastbound				
	Right to Wienke Way	Right	Thru	Left	U-Turn	Right	Thru to Wienke Way	Thru	Left	U-Turn	Right	Thru	Left to Wienke Way	Left	U-Turn	Right	Thru	Left	Left to Wienke Way	U-Turn	Right to California Ave	Right to Cabrillo Hwy (Hwy 1)	Thru to California Ave	Left to Cabrillo Hwy (Hwy 1)	U-Turn
4:00 PM	0	0	68	4	0	1	0	0	4	0	5	51	1	1	0	0	0	3	0	0	0	0	0	0	0
4:05 PM	0	0	64	0	0	0	0	0	1	0	3	53	3	0	0	0	0	0	0	0	0	0	0	0	0
4:10 PM	0	0	52	1	0	3	0	0	2	0	5	51	0	1	0	0	0	0	0	0	0	0	0	0	0
4:15 PM	1	0	57	2	0	0	0	0	1	0	3	54	0	1	0	4	1	0	0	0	0	0	0	0	0
4:20 PM	0	1	56	1	0	1	0	0	2	0	4	55	1	3	0	1	0	1	0	0	1	1	0	0	0
4:25 PM	1	0	61	0	0	3	0	0	4	0	1	53	0	3	0	0	0	1	0	0	0	0	0	0	0
4:30 PM	0	1	47	1	0	1	0	0	3	0	5	49	1	1	0	1	0	1	0	0	0	2	0	2	0
4:35 PM	0	0	57	1	0	0	0	0	3	0	3	53	0	1	0	0	0	0	0	0	0	1	0	0	0
4:40 PM	0	0	63	0	0	1	0	0	1	0	3	44	1	0	0	0	0	0	0	0	0	1	0	0	0
4:45 PM	0	1	63	1	0	2	0	0	3	0	4	48	1	1	0	0	0	0	0	0	0	0	0	0	0
4:50 PM	0	2	60	3	0	1	0	0	6	0	4	47	0	0	0	0	0	0	0	0	0	0	0	1	0
4:55 PM	1	0	62	3	0	1	0	0	0	0	8	45	0	0	0	0	0	1	0	0	1	0	0	0	0
5:00 PM	0	0	68	2	0	1	0	0	1	0	1	60	1	0	0	0	0	0	0	0	0	0	0	0	0
5:05 PM	0	0	55	1	0	2	0	0	2	0	2	54	0	0	0	1	0	0	0	0	0	0	0	0	0
5:10 PM	0	0	71	0	0	0	0	0	2	0	1	46	2	0	0	0	0	0	0	0	0	0	0	0	0
5:15 PM	0	1	58	2	0	2	0	0	4	0	4	53	0	2	0	1	0	0	0	0	0	0	0	0	0
5:20 PM	0	3	52	1	0	3	0	0	5	0	4	48	0	0	0	0	0	0	0	0	0	0	0	0	0
5:25 PM	0	0	72	2	0	0	0	0	3	0	1	50	0	1	0	1	0	0	0	0	0	0	0	0	0
5:30 PM	0	0	59	0	0	0	1	0	1	0	3	48	1	1	0	0	0	1	0	0	0	0	0	0	0
5:35 PM	0	2	77	2	0	0	0	0	0	0	1	62	1	0	0	0	0	0	0	0	0	1	0	0	0
5:40 PM	0	1	59	0	0	0	0	0	5	0	9	51	1	0	0	0	0	1	0	0	0	0	0	0	0
5:45 PM	0	0	45	0	0	0	0	1	2	0	9	37	1	0	0	0	0	2	0	0	1	1	0	0	0
5:50 PM	0	0	50	0	0	0	0	0	4	0	3	48	0	0	0	0	0	0	0	0	0	0	0	0	0
5:55 PM	0	0	69	0	0	1	0	0	2	0	3	59	1	0	0	0	0	0	0	0	1	1	0	0	0
Total	3	12	1445	27	0	23	1	1	61	0	89	1219	16	16	0	9	1	11	0	0	4	8	0	3	0

Peak Hour: 4:45 PM - 5:45 PM

Peak 15: 5:30 PM - 5:45 PM

PHF: 0.907609



Location: California Ave & Cabrillo Hwy

Date: 4/20/2017

Site Code: 14384626

Location:	Cabrillo Hwy (Hwy 1) Southbound					California Ave Westbound					Cabrillo Hwy (Hwy 1) Northbound					California Ave Eastbound					Wienke Way Southeastbound				
	Right to Wienke Way	Right	Thru	Left	U-Turn	Right	Thru to Wienke Way	Thru	Left	U-Turn	Right	Thru	Left to Wienke Way	Left	U-Turn	Right	Thru	Left	Left to Wienke Way	U-Turn	Right to California Ave	Right to Cabrillo Hwy (Hwy 1)	Thru to California Ave	Left to Cabrillo Hwy (Hwy 1)	U-Turn
4:00 PM	0	0	67	4	0	1	0	0	4	0	5	50	1	1	0	0	0	3	0	0	0	0	0	0	0
4:05 PM	0	0	61	0	0	0	0	0	1	0	3	51	3	0	0	0	0	0	0	0	0	0	0	0	0
4:10 PM	0	0	49	1	0	3	0	0	2	0	5	50	0	1	0	0	0	0	0	0	0	0	0	0	0
4:15 PM	1	0	57	2	0	0	0	0	1	0	3	53	0	1	0	4	1	0	0	0	0	0	0	0	0
4:20 PM	0	1	53	1	0	1	0	0	2	0	4	52	1	3	0	1	0	1	0	0	0	1	0	0	0
4:25 PM	1	0	61	0	0	3	0	0	4	0	1	52	0	3	0	0	0	1	0	0	0	0	0	0	0
4:30 PM	0	1	45	1	0	1	0	0	3	0	5	49	1	1	0	1	0	1	0	0	0	2	0	2	0
4:35 PM	0	0	53	1	0	0	0	0	3	0	3	52	0	1	0	0	0	0	0	0	0	1	0	0	0
4:40 PM	0	0	62	0	0	1	0	0	1	0	3	41	1	0	0	0	0	0	0	0	0	1	0	0	0
4:45 PM	0	1	61	1	0	2	0	0	3	0	4	47	1	1	0	0	0	0	0	0	0	0	0	0	0
4:50 PM	0	2	58	3	0	1	0	0	6	0	4	44	0	0	0	0	0	0	0	0	0	0	0	1	0
4:55 PM	1	0	62	3	0	1	0	0	0	0	7	45	0	0	0	0	1	0	0	0	1	0	0	0	0
5:00 PM	0	0	65	2	0	1	0	0	1	0	1	57	1	0	0	0	0	0	0	0	0	0	0	0	0
5:05 PM	0	0	55	1	0	2	0	0	2	0	2	52	0	0	0	1	0	0	0	0	0	0	0	0	0
5:10 PM	0	0	70	0	0	0	0	0	2	0	1	45	2	0	0	0	0	0	0	0	0	0	0	0	0
5:15 PM	0	1	58	2	0	2	0	0	4	0	4	53	0	2	0	1	0	0	0	0	0	0	0	0	0
5:20 PM	0	3	51	1	0	3	0	0	5	0	4	47	0	0	0	0	0	0	0	0	0	0	0	0	0
5:25 PM	0	0	70	2	0	0	0	0	2	0	1	49	0	1	0	1	0	0	0	0	0	0	0	0	0
5:30 PM	0	0	58	0	0	0	1	0	0	0	3	48	1	1	0	0	0	1	0	0	0	0	0	0	0
5:35 PM	0	2	76	2	0	0	0	0	0	0	1	62	1	0	0	0	0	0	0	0	0	1	0	0	0
5:40 PM	0	1	57	0	0	0	0	0	5	0	9	51	1	0	0	0	0	0	0	0	0	0	0	0	0
5:45 PM	0	0	45	0	0	0	0	1	2	0	9	36	1	0	0	0	0	2	0	0	1	1	0	0	0
5:50 PM	0	0	50	0	0	0	0	0	4	0	3	47	0	0	0	0	0	0	0	0	0	0	0	0	0
5:55 PM	0	0	69	0	0	1	0	0	2	0	3	59	1	0	0	0	0	0	0	0	1	1	0	0	0
Total	3	12	1413	27	0	23	1	1	59	0	88	1192	16	16	0	9	1	10	0	0	3	8	0	3	0



Location: California Ave & Cabrillo Hwy

Date: 4/20/2017

Site Code: 14384626

Location:	Cabrillo Hwy (Hwy 1) Southbound				California Ave Westbound				Cabrillo Hwy (Hwy 1) Northbound				California Ave Eastbound				Wienke Way Southeastbound			
	Right to Wienke Way	Right	Thru	Left	Right	Thru to Wienke Way	Thru	Left	Right	Thru	Left to Wienke Way	Left	Right	Thru	Left	Left to Wienke Way	Right to California Ave	Right to Cabrillo Hwy (Hwy 1)	Thru to California Ave	Left to Cabrillo Hwy (Hwy 1)
4:00 PM	0	0	1	0	0	0	0	0	0	1	0	0	0	0	0	0	0	0	0	0
4:05 PM	0	0	3	0	0	0	0	0	0	2	0	0	0	0	0	0	0	0	0	0
4:10 PM	0	0	3	0	0	0	0	0	0	1	0	0	0	0	0	0	0	0	0	0
4:15 PM	0	0	0	0	0	0	0	0	0	1	0	0	0	0	0	0	0	0	0	0
4:20 PM	0	0	3	0	0	0	0	0	0	3	0	0	0	0	0	0	1	0	0	0
4:25 PM	0	0	0	0	0	0	0	0	0	1	0	0	0	0	0	0	0	0	0	0
4:30 PM	0	0	2	0	0	0	0	0	0	0	0	0	0	0	0	0	0	0	0	0
4:35 PM	0	0	4	0	0	0	0	0	0	1	0	0	0	0	0	0	0	0	0	0
4:40 PM	0	0	1	0	0	0	0	0	0	3	0	0	0	0	0	0	0	0	0	0
4:45 PM	0	0	2	0	0	0	0	0	0	1	0	0	0	0	0	0	0	0	0	0
4:50 PM	0	0	2	0	0	0	0	0	0	3	0	0	0	0	0	0	0	0	0	0
4:55 PM	0	0	0	0	0	0	0	0	1	0	0	0	0	0	0	0	0	0	0	0
5:00 PM	0	0	3	0	0	0	0	0	0	3	0	0	0	0	0	0	0	0	0	0
5:05 PM	0	0	0	0	0	0	0	0	0	2	0	0	0	0	0	0	0	0	0	0
5:10 PM	0	0	1	0	0	0	0	0	0	1	0	0	0	0	0	0	0	0	0	0
5:15 PM	0	0	0	0	0	0	0	0	0	0	0	0	0	0	0	0	0	0	0	0
5:20 PM	0	0	1	0	0	0	0	1	0	1	0	0	0	0	0	0	0	0	0	0
5:25 PM	0	0	2	0	0	0	0	1	0	1	0	0	0	0	0	0	0	0	0	0
5:30 PM	0	0	1	0	0	0	0	1	0	0	0	0	0	0	0	0	0	0	0	0
5:35 PM	0	0	1	0	0	0	0	0	0	0	0	0	0	0	0	0	0	0	0	0
5:40 PM	0	0	2	0	0	0	0	0	0	0	0	0	0	0	1	0	0	0	0	0
5:45 PM	0	0	0	0	0	0	0	0	0	1	0	0	0	0	0	0	0	0	0	0
5:50 PM	0	0	0	0	0	0	0	0	0	1	0	0	0	0	0	0	0	0	0	0
5:55 PM	0	0	0	0	0	0	0	0	0	0	0	0	0	0	0	0	0	0	0	0
Total	0	0	32	0	0	0	0	2	1	27	0	0	0	0	0	1	0	0	0	0



Location: California Ave & Cabrillo Hwy

Date: 4/20/2017

Site Code: 14384626

Location:	Cabrillo Hwy (Hwy 1) Southbound					California Ave Westbound					Cabrillo Hwy (Hwy 1) Northbound					California Ave Eastbound					Wienke Way Southeastbound				
	Right to Wienke Way	Right	Thru	Left	Peds	Right	Thru to Wienke Way	Thru	Left	Peds	Right	Thru	Left to Wienke Way	Left	Peds	Right	Thru	Left	Left to Wienke Way	Peds	Right to California Ave	Right to Cabrillo Hwy (Hwy 1)	Thru to California Ave	Left to Cabrillo Hwy (Hwy 1)	Peds
4:00 PM	0	0	0	0	1	0	0	0	0	0	0	0	0	0	0	0	0	0	0	0	0	0	0	0	0
4:05 PM	0	0	0	0	0	0	0	0	0	0	0	0	0	0	0	0	0	0	0	0	0	0	0	0	0
4:10 PM	0	0	0	0	1	0	0	0	0	0	0	0	0	0	1	0	0	0	0	0	0	0	0	0	0
4:15 PM	0	0	0	0	0	0	0	0	0	0	0	0	0	0	0	0	0	0	0	0	1	0	0	0	0
4:20 PM	0	0	0	0	0	0	0	0	0	0	0	0	0	0	0	0	0	0	0	0	0	0	0	0	0
4:25 PM	0	0	0	0	0	0	0	0	0	0	0	0	0	0	0	0	0	0	0	0	0	0	0	0	0
4:30 PM	0	0	0	0	0	0	0	0	0	0	0	0	0	0	1	0	0	0	0	0	0	0	0	0	0
4:35 PM	0	0	0	0	0	0	0	0	0	0	0	0	0	0	0	0	0	0	0	0	0	0	0	0	0
4:40 PM	0	0	0	0	0	0	0	0	0	0	0	0	0	0	0	0	0	0	0	0	0	0	0	0	0
4:45 PM	0	0	0	0	1	0	0	0	0	0	0	0	0	0	0	0	0	0	0	0	0	0	0	0	0
4:50 PM	0	0	0	0	0	0	0	0	0	0	0	0	0	0	0	0	0	0	0	0	0	0	0	0	0
4:55 PM	0	0	0	0	0	0	0	0	0	0	0	0	0	0	0	0	0	0	0	0	0	0	0	0	0
5:00 PM	0	0	0	0	0	0	0	0	0	0	0	0	0	0	0	0	0	0	0	0	0	0	0	0	0
5:05 PM	0	0	0	0	0	0	0	0	0	0	0	0	0	0	0	0	0	0	0	0	0	0	0	0	0
5:10 PM	0	0	0	0	0	0	0	0	0	0	0	0	0	0	0	0	0	0	0	0	1	0	0	0	0
5:15 PM	0	0	0	0	0	0	0	0	0	0	0	0	0	0	0	0	0	0	0	0	0	0	0	0	0
5:20 PM	0	0	0	0	0	0	0	0	0	0	0	0	0	0	0	0	0	0	0	0	0	0	0	0	0
5:25 PM	0	0	0	0	0	0	0	0	0	0	0	0	0	0	0	0	0	0	0	0	0	0	0	0	0
5:30 PM	0	0	0	0	0	0	0	0	0	0	0	0	0	0	0	0	0	0	0	0	0	0	0	0	0
5:35 PM	0	0	0	0	0	0	0	0	0	0	0	0	0	0	0	0	0	0	0	0	0	0	0	0	0
5:40 PM	0	0	0	0	0	0	0	0	0	0	0	0	0	0	0	0	0	0	0	0	0	0	0	0	0
5:45 PM	0	0	0	0	0	0	0	0	0	0	0	1	0	0	0	0	0	0	0	0	3	0	0	0	0
5:50 PM	0	0	0	0	0	0	0	0	0	0	0	1	0	0	0	0	0	0	0	0	0	0	0	0	0
5:55 PM	0	0	0	0	0	0	0	0	0	0	0	0	0	0	0	0	0	0	0	0	0	0	0	0	0
Total	0	0	0	0	3	0	0	0	0	0	0	2	0	0	2	0	0	0	0	5	0	0	0	0	0



Location: California Ave & Cabrillo Hwy

Date: 4/22/2017

Site Code: 14384627

Location:	Cabrillo Hwy (Hwy 1) Southbound					California Ave Westbound					Cabrillo Hwy (Hwy 1) Northbound					California Ave Eastbound					Wienke Way Southeastbound				
	Right to Wienke Way	Right	Thru	Left	U-Turn	Right	Thru to Wienke Way	Thru	Left	U-Turn	Right	Thru	Left to Wienke Way	Left	U-Turn	Right	Thru	Left	Left to Wienke Way	U-Turn	Right to California Ave	Right to Cabrillo Hwy (Hwy 1)	Thru to California Ave	Left to Cabrillo Hwy (Hwy 1)	U-Turn
11:00 AM	1	0	66	0	0	1	0	1	1	0	2	49	1	1	0	1	0	1	0	0	1	0	0	0	0
11:05 AM	1	2	76	1	0	1	0	1	3	0	3	53	0	2	0	0	1	0	0	0	1	2	0	0	0
11:10 AM	0	0	74	1	0	4	0	0	3	0	3	47	0	0	0	1	0	1	0	0	0	0	0	0	0
11:15 AM	0	0	64	1	0	1	0	0	0	0	6	58	0	4	0	2	1	1	0	0	0	0	1	0	0
11:20 AM	0	0	83	1	0	1	0	0	1	0	3	46	1	1	0	1	0	1	0	0	0	1	0	0	0
11:25 AM	1	0	59	0	0	1	0	0	2	0	4	64	0	2	0	0	0	2	0	0	0	1	0	0	0
11:30 AM	0	1	79	1	0	3	0	0	1	0	4	31	1	1	0	2	0	0	0	0	0	1	0	0	0
11:35 AM	1	0	75	0	0	1	0	0	6	0	5	52	0	0	0	2	0	1	0	0	1	2	0	0	0
11:40 AM	0	0	75	1	0	0	0	0	4	0	9	40	1	2	0	2	0	1	1	0	0	1	0	0	0
11:45 AM	0	0	79	0	0	1	0	0	3	0	4	38	0	0	0	2	0	0	0	0	0	1	0	0	0
11:50 AM	0	0	70	1	0	0	0	0	0	0	4	40	0	1	0	0	0	0	0	0	0	1	0	0	0
11:55 AM	0	1	73	1	0	2	1	1	2	0	2	48	1	1	0	0	0	0	0	0	0	0	0	0	0
12:00 PM	0	0	87	0	0	5	0	0	1	0	3	54	0	0	0	4	0	1	0	0	0	2	0	1	0
12:05 PM	1	0	82	1	0	2	0	0	3	0	4	40	0	0	0	0	0	0	0	0	0	0	0	0	0
12:10 PM	1	1	67	0	0	1	0	1	1	0	1	63	0	4	0	2	0	1	0	0	0	2	0	0	0
12:15 PM	0	1	70	1	0	2	0	0	2	0	0	57	0	4	1	2	0	0	0	0	0	0	0	0	0
12:20 PM	0	0	76	0	0	0	0	0	1	0	3	61	0	3	0	3	0	0	1	0	0	0	0	0	0
12:25 PM	1	1	91	1	0	1	0	0	4	0	4	51	0	3	0	1	0	0	0	0	0	0	0	0	0
12:30 PM	0	0	51	0	0	1	0	0	1	0	2	65	1	3	0	1	0	1	0	0	0	1	0	0	0
12:35 PM	0	0	69	0	0	1	0	0	1	0	5	46	0	3	0	1	2	1	0	0	0	0	1	0	0
12:40 PM	0	1	69	0	0	2	0	1	5	0	4	47	0	3	0	3	0	0	0	0	0	2	0	2	0
12:45 PM	0	1	65	1	0	5	0	0	1	0	5	62	0	4	1	1	1	0	0	0	0	0	0	0	0
12:50 PM	2	1	64	1	0	0	0	0	1	0	3	58	0	0	0	3	0	1	0	0	0	0	0	0	0
12:55 PM	0	0	61	1	0	1	0	0	0	0	2	53	1	0	0	0	0	0	0	0	0	1	0	0	0
Total	9	10	1725	14	0	37	1	5	47	0	85	1223	7	42	2	34	5	13	2	0	3	18	2	3	0

Peak Hour: 11:55 AM - 12:55 PM

Peak 15: 12:40 PM - 12:55 PM

PHF: 0.952381



Location: California Ave & Cabrillo Hwy

Date: 4/22/2017

Site Code: 14384627

Location:	Cabrillo Hwy (Hwy 1) Southbound					California Ave Westbound					Cabrillo Hwy (Hwy 1) Northbound					California Ave Eastbound					Wienke Way Southeastbound				
	Right to Wienke Way	Right	Thru	Left	U-Turn	Right	Thru to Wienke Way	Thru	Left	U-Turn	Right	Thru	Left to Wienke Way	Left	U-Turn	Right	Thru	Left	Left to Wienke Way	U-Turn	Right to California Ave	Right to Cabrillo Hwy (Hwy 1)	Thru to California Ave	Left to Cabrillo Hwy (Hwy 1)	U-Turn
11:00 AM	1	0	64	0	0	1	0	1	1	0	2	49	1	1	0	1	0	1	0	0	1	0	0	0	0
11:05 AM	0	2	76	1	0	1	0	1	3	0	3	53	0	2	0	0	0	1	0	0	0	0	2	0	0
11:10 AM	0	0	72	1	0	4	0	0	3	0	3	45	0	0	0	1	0	1	0	0	0	0	0	0	0
11:15 AM	0	0	63	1	0	1	0	0	0	0	6	57	0	4	0	2	1	1	0	0	0	0	1	0	0
11:20 AM	0	0	82	1	0	1	0	0	1	0	3	45	1	1	0	1	0	1	0	0	0	1	0	0	0
11:25 AM	1	0	59	0	0	1	0	0	2	0	4	63	0	2	0	0	0	2	0	0	0	1	0	0	0
11:30 AM	0	1	77	1	0	3	0	0	1	0	4	31	1	1	0	2	0	0	0	0	0	1	0	0	0
11:35 AM	1	0	72	0	0	1	0	0	6	0	5	51	0	0	0	2	0	1	0	0	1	2	0	0	0
11:40 AM	0	0	75	1	0	0	0	0	4	0	9	40	1	2	0	2	0	1	1	0	0	1	0	0	0
11:45 AM	0	0	79	0	0	1	0	0	3	0	4	37	0	0	0	2	0	0	0	0	0	1	0	0	0
11:50 AM	0	0	66	1	0	0	0	0	0	0	4	39	0	1	0	0	0	0	0	0	0	1	0	0	0
11:55 AM	0	1	73	1	0	2	1	1	2	0	2	47	1	1	0	0	0	0	0	0	0	0	0	0	0
12:00 PM	0	0	87	0	0	5	0	0	1	0	3	54	0	0	0	4	0	1	0	0	0	2	0	1	0
12:05 PM	1	0	82	1	0	2	0	0	3	0	4	40	0	0	0	0	0	0	0	0	0	0	0	0	0
12:10 PM	1	1	66	0	0	1	0	1	1	0	1	63	0	4	0	2	0	1	0	0	0	2	0	0	0
12:15 PM	0	1	69	1	0	2	0	0	2	0	0	57	0	4	1	2	0	0	0	0	0	0	0	0	0
12:20 PM	0	0	74	0	0	0	0	0	1	0	3	60	0	3	0	3	0	0	1	0	0	0	0	0	0
12:25 PM	1	1	89	1	0	1	0	0	4	0	4	48	0	3	0	1	0	0	0	0	0	0	0	0	0
12:30 PM	0	0	48	0	0	1	0	0	1	0	2	63	1	3	0	1	0	1	0	0	0	1	0	0	0
12:35 PM	0	0	65	0	0	1	0	0	1	0	5	45	0	3	0	1	2	1	0	0	0	0	1	0	0
12:40 PM	0	1	68	0	0	2	0	1	5	0	4	45	0	3	0	3	0	0	0	0	0	2	0	2	0
12:45 PM	0	1	64	1	0	5	0	0	1	0	5	59	0	4	1	1	1	0	0	0	0	0	0	0	0
12:50 PM	2	1	64	1	0	0	0	0	1	0	3	57	0	0	0	3	0	1	0	0	0	0	0	0	0
12:55 PM	0	0	57	1	0	1	0	0	0	0	2	53	1	0	0	0	0	0	0	0	0	1	0	0	0
Total	8	10	1691	14	0	37	1	5	47	0	85	1201	7	42	2	34	5	13	2	0	2	18	2	3	0



Location: California Ave & Cabrillo Hwy

Date: 4/22/2017

Site Code: 14384627

Location:	Cabrillo Hwy (Hwy 1) Southbound				California Ave Westbound				Cabrillo Hwy (Hwy 1) Northbound				California Ave Eastbound				Wienke Way Southeastbound			
	Right to Wienke Way	Right	Thru	Left	Right	Thru to Wienke Way	Thru	Left	Right	Thru	Left to Wienke Way	Left	Right	Thru	Left	Left to Wienke Way	Right to California Ave	Right to Cabrillo Hwy (Hwy 1)	Thru to California Ave	Left to Cabrillo Hwy (Hwy 1)
11:00 AM	0	0	2	0	0	0	0	0	0	0	0	0	0	0	0	0	0	0	0	0
11:05 AM	1	0	0	0	0	0	0	0	0	0	0	0	0	0	0	0	0	1	0	0
11:10 AM	0	0	2	0	0	0	0	0	0	0	2	0	0	0	0	0	0	0	0	0
11:15 AM	0	0	1	0	0	0	0	0	0	0	1	0	0	0	0	0	0	0	0	0
11:20 AM	0	0	1	0	0	0	0	0	0	0	1	0	0	0	0	0	0	0	0	0
11:25 AM	0	0	0	0	0	0	0	0	0	0	1	0	0	0	0	0	0	0	0	0
11:30 AM	0	0	2	0	0	0	0	0	0	0	0	0	0	0	0	0	0	0	0	0
11:35 AM	0	0	3	0	0	0	0	0	0	0	1	0	0	0	0	0	0	0	0	0
11:40 AM	0	0	0	0	0	0	0	0	0	0	0	0	0	0	0	0	0	0	0	0
11:45 AM	0	0	0	0	0	0	0	0	0	0	1	0	0	0	0	0	0	0	0	0
11:50 AM	0	0	4	0	0	0	0	0	0	0	1	0	0	0	0	0	0	0	0	0
11:55 AM	0	0	0	0	0	0	0	0	0	0	1	0	0	0	0	0	0	0	0	0
12:00 PM	0	0	0	0	0	0	0	0	0	0	0	0	0	0	0	0	0	0	0	0
12:05 PM	0	0	0	0	0	0	0	0	0	0	0	0	0	0	0	0	0	0	0	0
12:10 PM	0	0	1	0	0	0	0	0	0	0	0	0	0	0	0	0	0	0	0	0
12:15 PM	0	0	1	0	0	0	0	0	0	0	0	0	0	0	0	0	0	0	0	0
12:20 PM	0	0	2	0	0	0	0	2	0	0	1	0	0	0	0	0	0	0	0	0
12:25 PM	0	0	2	0	0	0	0	0	0	0	3	0	0	0	0	0	0	0	0	0
12:30 PM	0	0	3	0	0	0	0	0	0	0	2	0	0	0	0	0	0	0	0	0
12:35 PM	0	0	4	0	0	0	0	0	0	0	1	0	0	0	0	0	0	0	0	0
12:40 PM	0	0	1	0	0	0	0	1	0	0	2	0	0	0	0	0	0	0	0	0
12:45 PM	0	0	1	0	0	0	0	0	0	0	3	0	0	0	0	0	0	0	0	0
12:50 PM	0	0	0	0	0	0	0	0	0	0	1	0	0	0	0	0	0	0	0	0
12:55 PM	0	0	4	0	0	0	0	0	0	0	0	0	0	0	0	0	0	0	0	0
Total	1	0	34	0	0	0	0	0	0	0	22	0	0	0	0	0	0	1	0	0

LOCATION: Carlos St -- California Ave
CITY/STATE: San Mateo, CA

QC JOB #: 14384622
DATE: Thu, Apr 20 2017

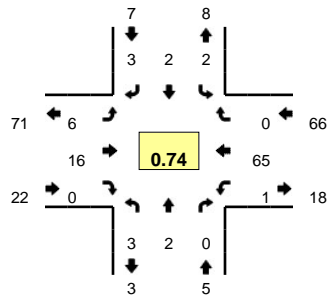

Peak-Hour: 7:25 AM -- 8:25 AM
Peak 15-Min: 7:30 AM -- 7:45 AM

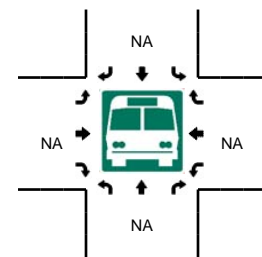
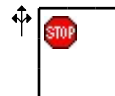
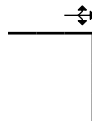
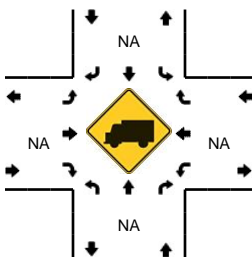
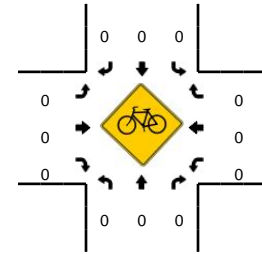
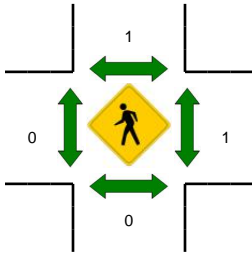
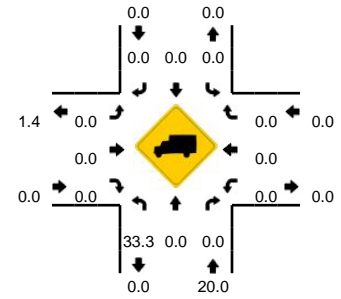

5-Min Count Period Beginning At	Carlos St (Northbound)				Carlos St (Southbound)				California Ave (Eastbound)				California Ave (Westbound)				Total	Hourly Totals
	Left	Thru	Right	U	Left	Thru	Right	U	Left	Thru	Right	U	Left	Thru	Right	U		
7:00 AM	0	0	0	0	0	0	0	0	0	0	0	0	0	2	0	0	2	
7:05 AM	0	0	0	0	0	0	0	0	0	0	0	0	0	7	0	0	7	
7:10 AM	0	0	0	0	0	0	0	0	0	1	0	0	0	1	5	0	7	
7:15 AM	0	1	0	0	0	0	0	0	0	0	0	0	0	3	0	0	4	
7:20 AM	0	0	0	0	0	0	0	0	0	0	0	0	0	4	0	0	4	
7:25 AM	0	0	0	0	0	0	0	0	0	1	0	0	0	6	0	0	7	
7:30 AM	0	0	0	0	1	0	0	0	0	1	2	0	0	0	9	0	13	
7:35 AM	0	1	0	0	0	0	0	0	0	0	1	0	0	0	5	0	7	
7:40 AM	2	0	0	0	0	0	0	0	0	0	2	0	0	0	10	0	14	
7:45 AM	0	0	0	0	1	0	0	0	0	0	2	0	0	0	5	0	8	
7:50 AM	0	0	0	0	0	0	1	0	0	1	1	0	0	0	3	0	6	
7:55 AM	0	1	0	0	0	0	0	0	0	1	1	0	0	0	4	0	7	86
8:00 AM	0	0	0	0	0	0	1	0	0	0	1	0	0	0	5	0	7	91
8:05 AM	0	0	0	0	0	0	1	0	0	1	1	0	0	0	5	0	8	92
8:10 AM	0	0	0	0	0	0	0	0	0	0	3	0	0	1	6	0	10	95
8:15 AM	1	0	0	0	0	1	0	0	0	1	1	0	0	0	2	0	6	97
8:20 AM	0	0	0	0	0	1	0	0	0	0	1	0	0	0	5	0	7	100
8:25 AM	0	0	0	0	0	0	0	0	0	0	1	0	0	0	5	0	6	99
8:30 AM	0	0	0	0	0	0	0	0	0	1	1	0	0	0	5	0	7	93
8:35 AM	0	1	0	0	0	0	2	0	0	2	4	0	0	0	5	0	14	100
8:40 AM	0	0	0	0	0	0	1	0	0	1	0	0	0	0	5	0	7	93
8:45 AM	0	0	0	0	0	0	0	0	0	0	1	0	0	0	2	1	4	89
8:50 AM	0	0	0	0	0	0	2	0	0	0	1	0	0	0	5	0	8	91
8:55 AM	0	1	0	0	0	0	1	0	0	2	4	0	0	0	5	1	14	98
Peak 15-Min Flowrates	Northbound				Southbound				Eastbound				Westbound				Total	
	Left	Thru	Right	U	Left	Thru	Right	U	Left	Thru	Right	U	Left	Thru	Right	U		
All Vehicles	8	4	0	0	4	0	0	0	4	20	0	0	0	96	0	0	136	
Heavy Trucks	4	0	0	0	0	0	0	0	0	0	0	0	0	0	0	0	4	
Pedestrians	0	0	0	0	0	0	0	0	0	0	0	0	0	0	0	0	0	
Bicycles	0	0	0	0	0	0	0	0	0	0	0	0	0	0	0	0	0	
Railroad																		
Stopped Buses																		

Comments:

LOCATION: Carlos St -- California Ave
CITY/STATE: San Mateo, CA

QC JOB #: 14384623
DATE: Thu, Apr 20 2017

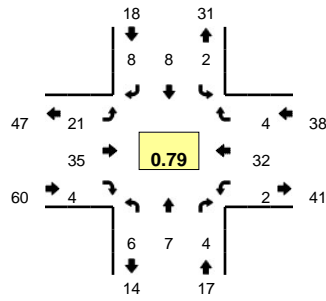

Peak-Hour: 4:00 PM -- 5:00 PM
Peak 15-Min: 4:45 PM -- 5:00 PM

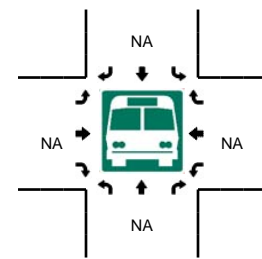
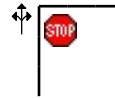
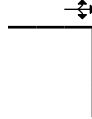
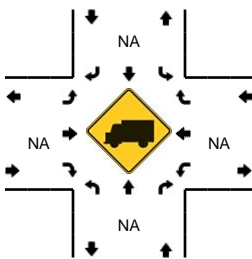
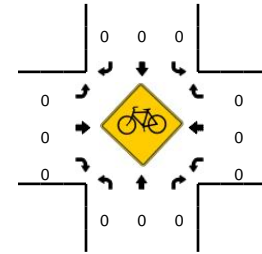
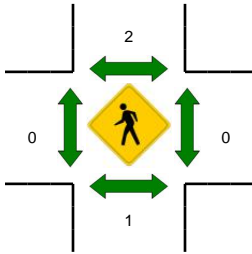
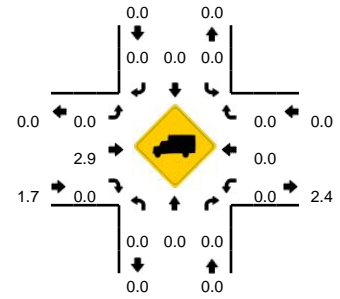

5-Min Count Period Beginning At	Carlos St (Northbound)				Carlos St (Southbound)				California Ave (Eastbound)				California Ave (Westbound)				Total	Hourly Totals	
	Left	Thru	Right	U	Left	Thru	Right	U	Left	Thru	Right	U	Left	Thru	Right	U			
4:00 PM	1	0	0	0	0	1	0	0	0	0	5	1	0	1	4	0	0	13	
4:05 PM	0	0	0	0	1	0	1	0	4	1	0	0	1	0	0	0	8		
4:10 PM	1	0	1	0	0	0	0	0	3	1	0	0	0	4	0	0	10		
4:15 PM	0	1	1	0	0	2	0	0	3	3	1	0	0	1	0	0	12		
4:20 PM	0	0	0	0	0	0	0	0	1	3	0	0	0	2	0	0	6		
4:25 PM	0	1	0	0	1	0	3	0	0	1	0	0	0	0	4	0	10		
4:30 PM	0	2	1	0	0	2	1	0	2	3	1	0	0	4	1	0	17		
4:35 PM	0	0	0	0	0	0	0	0	1	2	0	0	0	2	0	0	5		
4:40 PM	2	0	0	0	0	1	0	0	1	2	0	0	0	2	2	0	10		
4:45 PM	2	1	0	0	0	0	0	0	0	6	1	1	0	4	0	0	15		
4:50 PM	0	2	1	0	0	0	2	0	1	2	0	0	0	3	0	0	11		
4:55 PM	0	0	0	0	0	2	1	0	4	6	0	0	0	2	1	0	16	133	
5:00 PM	2	0	0	0	1	2	0	0	0	1	0	0	0	0	1	0	7	127	
5:05 PM	0	0	2	0	0	0	1	0	0	4	0	0	0	2	0	0	9	128	
5:10 PM	0	1	0	0	0	0	0	0	1	0	0	0	0	3	0	0	5	123	
5:15 PM	0	0	1	0	1	1	2	0	1	5	0	0	0	4	0	0	15	126	
5:20 PM	3	0	1	0	0	0	2	0	1	3	0	0	0	3	0	0	13	133	
5:25 PM	1	0	0	0	1	0	0	0	0	3	0	0	1	1	0	0	7	130	
5:30 PM	0	0	1	0	0	1	1	0	2	1	0	0	0	0	0	0	6	119	
5:35 PM	0	0	0	0	0	0	1	0	2	3	0	0	0	0	0	0	6	120	
5:40 PM	0	1	0	0	0	0	0	0	4	6	0	0	0	4	0	0	15	125	
5:45 PM	0	0	0	0	1	1	1	0	0	7	0	0	0	2	1	0	13	123	
5:50 PM	0	0	0	0	0	1	1	0	0	1	0	0	0	4	0	0	7	119	
5:55 PM	1	0	1	0	0	1	1	0	2	3	0	0	0	0	0	0	9	112	
Peak 15-Min Flowrates	Northbound				Southbound				Eastbound				Westbound				Total		
	Left	Thru	Right	U	Left	Thru	Right	U	Left	Thru	Right	U	Left	Thru	Right	U			
All Vehicles	8	12	4	0	0	8	12	0	20	56	4	4	0	36	4	0	168		
Heavy Trucks	0	0	0	0	0	0	0	0	0	4	0	0	0	0	0	0	4		
Pedestrians		4				0				0				0			4		
Bicycles	0	0	0		0	0	0		0	0	0		0	0	0		0		
Railroad																			
Stopped Buses																			

Comments:

LOCATION: Carlos St -- California Ave
CITY/STATE: San Mateo, CA

QC JOB #: 14384624
DATE: Sat, Apr 22 2017

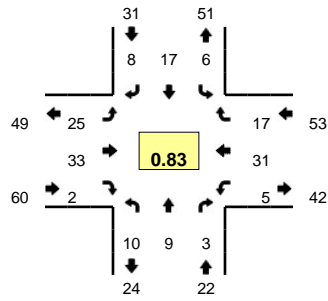

Peak-Hour: 11:10 AM -- 12:10 PM
Peak 15-Min: 11:35 AM -- 11:50 AM

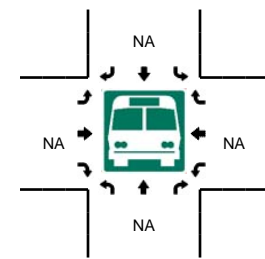
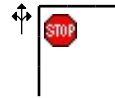
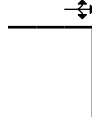
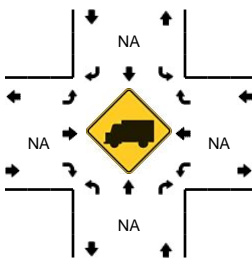
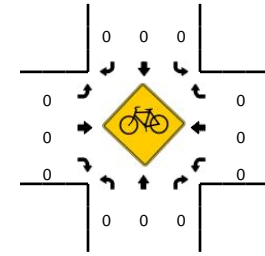
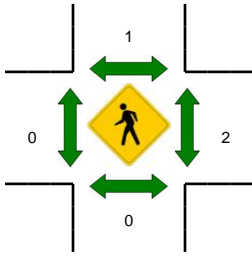
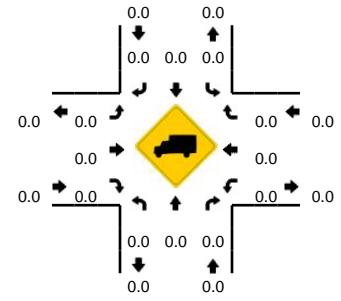

5-Min Count Period Beginning At	Carlos St (Northbound)				Carlos St (Southbound)				California Ave (Eastbound)				California Ave (Westbound)				Total	Hourly Totals
	Left	Thru	Right	U	Left	Thru	Right	U	Left	Thru	Right	U	Left	Thru	Right	U		
11:00 AM	0	0	0	0	1	0	3	0	1	2	0	0	0	2	0	0	9	
11:05 AM	2	1	0	0	0	1	1	0	0	3	0	0	0	1	1	0	10	
11:10 AM	1	0	0	0	0	0	0	0	3	4	0	0	0	5	4	0	17	
11:15 AM	1	0	0	0	0	3	0	0	3	2	0	0	0	0	0	0	9	
11:20 AM	0	3	0	0	0	1	0	0	0	4	0	0	0	3	1	0	12	
11:25 AM	0	0	0	0	1	1	1	0	2	2	0	0	0	1	1	0	9	
11:30 AM	3	1	0	0	0	1	2	0	3	4	0	0	0	1	1	0	16	
11:35 AM	1	0	0	0	0	1	1	0	4	4	0	0	0	4	1	0	16	
11:40 AM	0	2	0	0	1	1	2	0	2	3	0	0	1	3	1	0	16	
11:45 AM	0	1	2	0	0	3	0	0	3	3	0	0	1	1	4	0	18	
11:50 AM	0	1	0	0	2	3	0	0	0	2	1	0	0	1	2	0	12	
11:55 AM	1	0	0	0	1	0	1	0	2	0	1	0	0	3	1	0	10	154
12:00 PM	3	1	1	0	1	2	1	0	1	2	0	0	2	4	1	0	19	164
12:05 PM	0	0	0	0	0	1	0	0	2	3	0	0	1	5	0	0	12	166
12:10 PM	0	0	1	0	0	0	1	0	0	1	0	0	0	1	0	1	5	154
12:15 PM	0	2	1	0	0	0	1	0	1	1	0	0	0	3	0	0	9	154
12:20 PM	1	0	0	0	0	0	0	0	2	4	0	0	0	2	0	0	9	151
12:25 PM	0	1	0	0	0	1	0	0	0	2	0	0	0	2	0	0	6	148
12:30 PM	1	0	0	0	0	0	0	0	0	2	0	0	1	2	0	0	6	138
12:35 PM	1	1	1	0	1	0	0	0	5	3	1	0	0	2	0	0	15	137
12:40 PM	0	1	1	0	1	0	1	0	1	2	0	0	0	8	0	0	15	136
12:45 PM	2	0	0	0	1	0	1	0	1	5	1	0	0	0	0	0	11	129
12:50 PM	0	0	0	0	0	0	0	0	3	0	1	0	0	1	0	0	5	122
12:55 PM	0	0	0	0	0	0	1	0	1	1	0	0	0	0	1	0	4	116
Peak 15-Min Flowrates	Northbound				Southbound				Eastbound				Westbound				Total	
	Left	Thru	Right	U	Left	Thru	Right	U	Left	Thru	Right	U	Left	Thru	Right	U		
All Vehicles	4	12	8	0	4	20	12	0	36	40	0	0	8	32	24	0	200	
Heavy Trucks	0	0	0	0	0	0	0	0	0	0	0	0	0	0	0	0	0	
Pedestrians	0	0	0	0	0	4	0	0	0	0	0	0	0	4	0	0	8	
Bicycles	0	0	0	0	0	0	0	0	0	0	0	0	0	0	0	0	0	
Railroad																		
Stopped Buses																		

Comments:

LOCATION: Etheldore St -- California Ave
CITY/STATE: Moss Beach, CA

QC JOB #: 14384610
DATE: Thu, Apr 20 2017

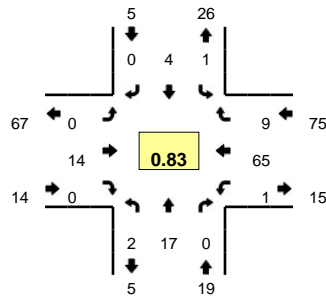

Peak-Hour: 7:15 AM -- 8:15 AM
Peak 15-Min: 7:30 AM -- 7:45 AM

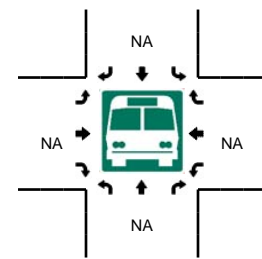
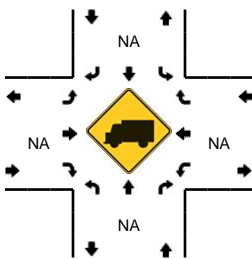
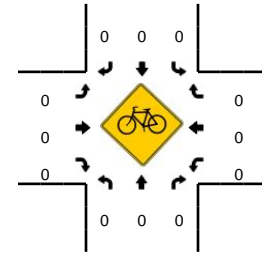
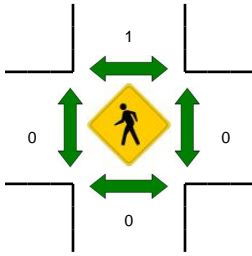
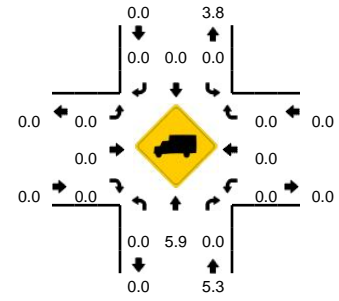

5-Min Count Period Beginning At	Etheldore St (Northbound)				Etheldore St (Southbound)				California Ave (Eastbound)				California Ave (Westbound)				Total	Hourly Totals
	Left	Thru	Right	U	Left	Thru	Right	U	Left	Thru	Right	U	Left	Thru	Right	U		
7:00 AM	0	1	0	0	0	1	1	0	0	0	0	0	0	2	2	0	7	
7:05 AM	1	1	0	0	0	0	0	0	0	0	0	0	0	5	0	0	7	
7:10 AM	0	0	0	0	0	0	0	0	0	0	0	0	0	6	0	0	6	
7:15 AM	0	4	0	0	0	1	0	0	0	0	0	0	0	3	2	0	10	
7:20 AM	0	1	0	0	0	0	0	0	0	0	0	0	0	4	1	0	6	
7:25 AM	1	2	0	0	0	0	0	0	0	0	0	0	0	8	1	0	12	
7:30 AM	0	1	0	0	0	0	0	0	0	0	3	0	0	6	1	0	11	
7:35 AM	0	2	0	0	0	0	0	0	0	0	1	0	0	5	0	0	8	
7:40 AM	0	2	0	0	0	0	0	0	0	0	2	0	0	10	1	0	15	
7:45 AM	0	1	0	0	0	1	0	0	0	0	2	0	0	5	1	0	10	
7:50 AM	0	0	0	0	1	1	0	0	0	0	0	0	0	3	1	0	6	
7:55 AM	0	0	0	0	0	0	0	0	0	0	1	0	0	4	1	0	6	104
8:00 AM	0	0	0	0	0	0	0	0	0	0	1	0	0	5	0	0	6	103
8:05 AM	0	1	0	0	0	0	0	0	0	0	1	0	0	5	0	0	7	103
8:10 AM	1	3	0	0	0	1	0	0	0	0	3	0	0	7	0	0	16	113
8:15 AM	0	1	0	0	0	1	0	0	0	0	0	1	0	1	2	0	6	109
8:20 AM	1	1	0	0	1	0	0	0	0	0	1	0	0	6	0	0	10	113
8:25 AM	0	0	0	0	0	0	0	0	0	0	0	0	0	4	0	0	4	105
8:30 AM	0	1	0	0	1	0	0	0	0	0	1	0	0	6	0	0	10	104
8:35 AM	0	3	0	0	0	0	1	0	0	0	4	0	0	3	1	0	12	108
8:40 AM	2	1	0	0	0	0	1	0	0	0	0	0	0	2	0	0	6	99
8:45 AM	0	1	0	0	0	0	0	0	0	0	0	0	0	3	0	0	4	93
8:50 AM	0	2	1	0	0	0	0	0	0	0	1	0	0	7	0	0	11	98
8:55 AM	0	1	0	0	0	0	0	0	0	0	2	0	0	4	0	0	7	99
Peak 15-Min Flowrates	Northbound				Southbound				Eastbound				Westbound				Total	
	Left	Thru	Right	U	Left	Thru	Right	U	Left	Thru	Right	U	Left	Thru	Right	U		
All Vehicles	0	20	0	0	0	0	0	0	0	24	0	0	0	84	8	0	136	
Heavy Trucks	0	4	0	0	0	0	0	0	0	0	0	0	0	0	0	0	4	
Pedestrians	0	0	0	0	0	0	0	0	0	0	0	0	0	0	0	0	0	
Bicycles	0	0	0	0	0	0	0	0	0	0	0	0	0	0	0	0	0	
Railroad																		
Stopped Buses																		

Comments:

LOCATION: Etheldore St -- California Ave
CITY/STATE: Moss Beach, CA

QC JOB #: 14384611
DATE: Thu, Apr 20 2017

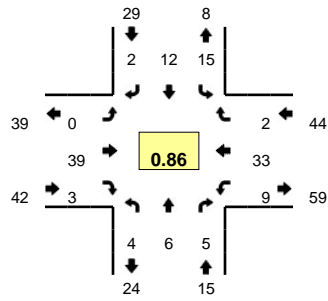

Peak-Hour: 4:25 PM -- 5:25 PM
Peak 15-Min: 5:10 PM -- 5:25 PM

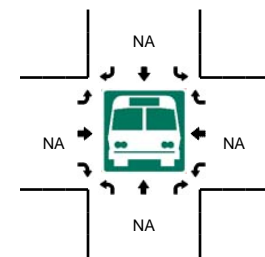
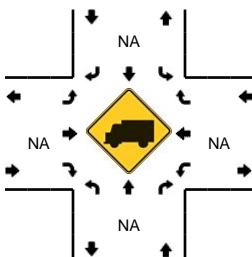
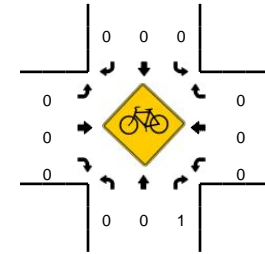
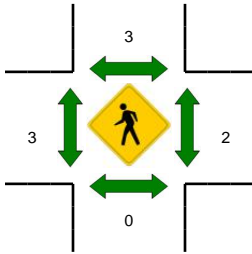
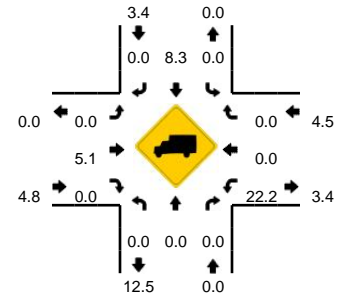

5-Min Count Period Beginning At	Etheldore St (Northbound)				Etheldore St (Southbound)				California Ave (Eastbound)				California Ave (Westbound)				Total	Hourly Totals	
	Left	Thru	Right	U	Left	Thru	Right	U	Left	Thru	Right	U	Left	Thru	Right	U			
4:00 PM	0	0	1	0	1	0	0	0	0	5	0	0	0	0	4	0	0	11	
4:05 PM	0	1	1	0	0	1	0	0	0	2	0	0	0	0	1	0	0	6	
4:10 PM	1	0	1	0	1	1	0	0	1	2	0	0	1	3	0	0	11		
4:15 PM	0	1	0	0	1	3	0	0	0	4	0	0	0	1	0	0	10		
4:20 PM	1	1	0	0	0	0	0	0	0	2	1	0	0	1	0	0	6		
4:25 PM	0	1	0	0	0	3	0	0	0	2	0	0	1	4	0	0	11		
4:30 PM	0	0	0	0	0	1	0	0	0	2	1	0	1	7	0	0	12		
4:35 PM	0	0	1	0	1	2	0	0	0	2	0	0	1	0	0	0	7		
4:40 PM	2	0	0	0	1	0	0	0	0	2	0	0	0	3	0	0	8		
4:45 PM	1	0	1	0	3	1	1	0	0	5	0	0	0	2	0	0	14		
4:50 PM	0	1	0	0	0	2	0	0	0	3	0	0	0	3	0	0	9		
4:55 PM	1	0	0	0	1	0	0	0	0	6	0	0	0	2	0	0	10	115	
5:00 PM	0	2	1	0	1	1	0	0	0	2	0	0	0	1	2	0	10	114	
5:05 PM	0	0	1	0	1	1	0	0	0	6	1	0	0	1	0	0	11	119	
5:10 PM	0	0	0	0	3	0	1	0	0	0	0	0	0	4	0	0	8	116	
5:15 PM	0	0	0	0	2	0	0	0	0	5	1	0	3	2	0	0	13	119	
5:20 PM	0	2	1	0	2	1	0	0	0	4	0	0	3	4	0	0	17	130	
5:25 PM	0	0	2	0	0	1	0	0	0	4	0	0	1	1	0	0	9	128	
5:30 PM	0	0	1	0	1	0	0	0	0	1	0	0	0	0	0	0	3	119	
5:35 PM	0	1	0	0	1	2	0	0	0	1	0	0	0	0	0	0	5	117	
5:40 PM	0	0	0	0	1	0	0	0	0	6	0	0	0	3	0	0	10	119	
5:45 PM	1	2	0	0	1	1	0	0	0	5	1	0	1	2	0	0	14	119	
5:50 PM	0	0	0	0	0	1	0	0	0	2	0	0	1	4	0	0	8	118	
5:55 PM	0	0	0	0	1	1	0	0	0	3	1	0	0	0	0	0	6	114	
Peak 15-Min Flowrates	Northbound				Southbound				Eastbound				Westbound				Total		
	Left	Thru	Right	U	Left	Thru	Right	U	Left	Thru	Right	U	Left	Thru	Right	U			
All Vehicles	0	8	4	0	28	4	4	0	0	36	4	0	24	40	0	0	152		
Heavy Trucks	0	0	0		0	0	0		0	4	0		8	0	0		12		
Pedestrians	0				0				12				0				12		
Bicycles	0	0	1		0	0	0		0	0	0		0	0	0		1		
Railroad																			
Stopped Buses																			

Comments:

LOCATION: Etheldore St -- California Ave
CITY/STATE: Moss Beach, CA

QC JOB #: 14384612
DATE: Sat, Apr 22 2017

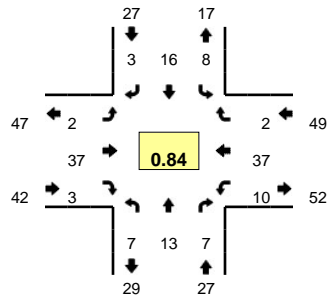

Peak-Hour: 11:45 AM -- 12:45 PM
Peak 15-Min: 12:00 PM -- 12:15 PM

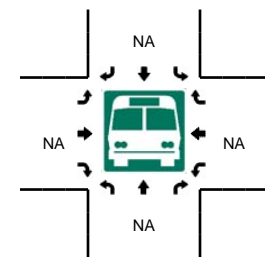
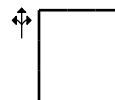
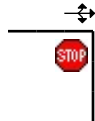
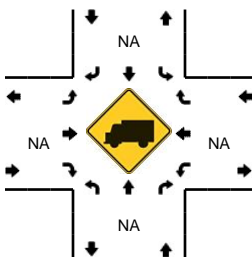
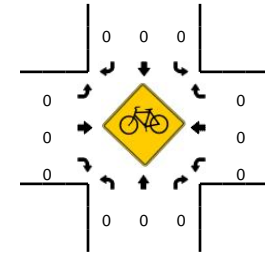
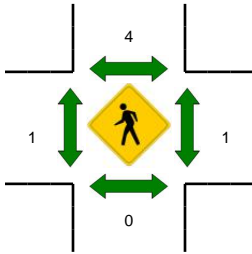
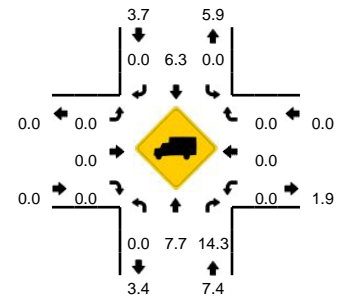

5-Min Count Period Beginning At	Etheldore St (Northbound)				Etheldore St (Southbound)				California Ave (Eastbound)				California Ave (Westbound)				Total	Hourly Totals
	Left	Thru	Right	U	Left	Thru	Right	U	Left	Thru	Right	U	Left	Thru	Right	U		
11:00 AM	0	2	0	0	0	0	0	0	0	3	0	0	0	2	0	0	7	
11:05 AM	1	3	0	0	0	0	0	0	0	2	0	0	0	3	0	0	9	
11:10 AM	2	0	0	0	2	1	0	0	0	4	0	0	0	5	1	0	15	
11:15 AM	0	1	0	0	2	1	0	0	0	2	0	0	0	1	0	0	7	
11:20 AM	0	0	0	0	0	1	0	0	0	4	0	0	1	4	0	0	10	
11:25 AM	0	1	1	0	0	1	0	0	0	2	1	0	1	2	0	0	9	
11:30 AM	0	1	1	0	1	0	0	0	0	4	0	0	0	2	1	0	10	
11:35 AM	0	0	0	0	1	0	0	0	0	4	0	0	0	5	0	0	10	
11:40 AM	0	1	0	0	0	1	1	0	0	4	0	0	2	4	0	0	13	
11:45 AM	3	1	0	0	0	3	0	0	1	4	0	0	0	4	0	0	16	
11:50 AM	1	0	2	0	0	3	0	0	0	4	0	0	1	1	0	0	12	
11:55 AM	0	1	0	0	0	1	0	0	0	0	1	0	0	5	0	0	8	126
12:00 PM	2	2	1	0	2	2	2	0	0	4	0	0	1	2	1	0	19	138
12:05 PM	0	1	0	0	0	1	0	0	0	4	0	0	1	6	0	0	13	142
12:10 PM	0	2	1	0	3	1	0	0	0	2	1	0	0	1	0	0	11	138
12:15 PM	0	1	0	0	0	3	0	0	0	2	0	0	3	3	0	0	12	143
12:20 PM	0	2	2	0	0	0	0	0	0	3	0	0	1	2	0	0	10	143
12:25 PM	0	0	0	0	1	2	0	0	1	3	0	0	1	2	0	0	10	144
12:30 PM	0	2	0	0	0	0	0	0	0	2	0	0	1	3	0	0	8	142
12:35 PM	0	1	1	0	1	0	1	0	0	5	0	0	0	2	0	0	11	143
12:40 PM	1	0	0	0	1	0	0	0	0	4	1	0	1	6	1	0	15	145
12:45 PM	0	3	1	0	0	1	0	0	0	5	0	0	1	0	1	0	12	141
12:50 PM	0	1	0	0	0	4	1	0	0	0	0	0	0	0	0	0	6	135
12:55 PM	0	1	2	0	0	0	0	0	0	0	0	0	0	1	0	0	4	131
Peak 15-Min Flowrates	Northbound				Southbound				Eastbound				Westbound				Total	
	Left	Thru	Right	U	Left	Thru	Right	U	Left	Thru	Right	U	Left	Thru	Right	U		
All Vehicles	8	20	8	0	20	16	8	0	0	40	4	0	8	36	4	0	172	
Heavy Trucks	0	0	4		0	0	0		0	0	0		0	0	0		4	
Pedestrians		0				8				0				4			12	
Bicycles	0	0	0		0	0	0		0	0	0		0	0	0		0	
Railroad																		
Stopped Buses																		

Comments:

LOCATION: Stetson St -- California Ave
CITY/STATE: Moss Beach, CA

QC JOB #: 14384613
DATE: Thu, Apr 20 2017

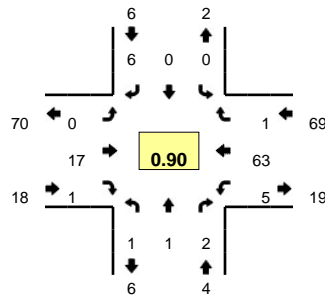

Peak-Hour: 7:30 AM -- 8:30 AM
Peak 15-Min: 7:35 AM -- 7:50 AM

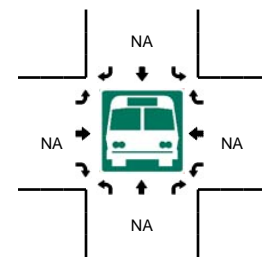
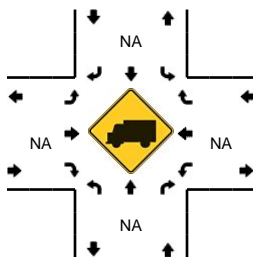
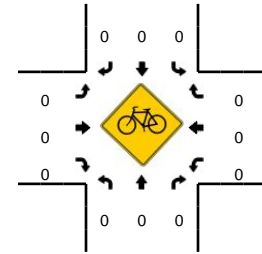
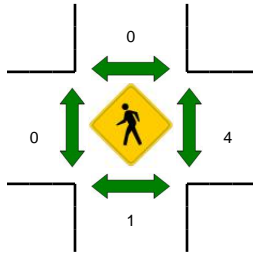
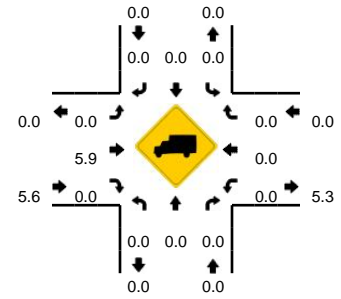

5-Min Count Period Beginning At	Stetson St (Northbound)				Stetson St (Southbound)				California Ave (Eastbound)				California Ave (Westbound)				Total	Hourly Totals
	Left	Thru	Right	U	Left	Thru	Right	U	Left	Thru	Right	U	Left	Thru	Right	U		
7:00 AM	0	0	0	0	0	0	1	0	0	0	0	0	0	5	0	0	6	
7:05 AM	0	0	0	0	0	0	0	0	0	0	0	0	0	5	0	0	5	
7:10 AM	1	0	0	0	0	0	0	0	0	0	0	0	0	2	0	0	3	
7:15 AM	0	0	0	0	0	0	0	0	0	0	0	0	0	10	0	0	10	
7:20 AM	0	0	0	0	0	0	0	0	0	0	0	0	0	4	0	0	4	
7:25 AM	1	0	1	0	0	0	0	0	0	0	0	0	0	7	0	0	9	
7:30 AM	0	0	0	0	0	0	2	0	0	1	0	0	0	5	0	0	8	
7:35 AM	0	0	0	0	0	0	0	0	0	2	1	0	0	5	0	0	8	
7:40 AM	1	0	0	0	0	0	0	0	0	0	0	0	0	8	0	0	9	
7:45 AM	0	0	0	0	0	0	1	0	0	3	0	0	0	5	1	0	10	
7:50 AM	0	0	0	0	0	0	0	0	0	2	0	0	0	6	0	0	8	
7:55 AM	0	0	0	0	0	0	0	0	0	2	0	0	0	6	0	0	8	88
8:00 AM	0	0	0	0	0	0	0	0	0	0	0	0	0	4	0	0	4	86
8:05 AM	0	0	0	0	0	0	1	0	0	2	0	0	0	3	0	0	6	87
8:10 AM	0	0	1	0	0	0	1	0	0	2	0	0	1	6	0	0	11	95
8:15 AM	0	0	0	0	0	0	1	0	0	1	0	0	2	5	0	0	9	94
8:20 AM	0	0	0	0	0	0	0	0	0	0	0	0	2	3	0	0	5	95
8:25 AM	0	1	1	0	0	0	0	0	0	2	0	0	0	7	0	0	11	97
8:30 AM	0	0	1	0	0	0	0	0	0	0	0	0	0	5	0	0	6	95
8:35 AM	0	0	2	0	0	0	0	0	1	2	0	0	0	4	0	0	9	96
8:40 AM	2	0	0	0	0	0	1	0	0	3	0	0	0	1	0	0	7	94
8:45 AM	0	0	0	0	0	0	0	0	0	0	0	0	0	3	0	0	3	87
8:50 AM	0	0	0	0	0	0	1	0	1	0	0	0	0	4	0	0	6	85
8:55 AM	0	0	0	0	0	0	0	0	0	2	0	0	0	4	0	0	6	83
Peak 15-Min Flowrates	Northbound				Southbound				Eastbound				Westbound				Total	
	Left	Thru	Right	U	Left	Thru	Right	U	Left	Thru	Right	U	Left	Thru	Right	U		
All Vehicles	4	0	0	0	0	0	4	0	0	20	4	0	0	72	4	0	108	
Heavy Trucks	0	0	0	0	0	0	0	0	0	0	0	0	0	0	0	0	0	
Pedestrians	0	0	0	0	0	0	0	0	0	0	0	0	0	0	0	0	0	
Bicycles	0	0	0	0	0	0	0	0	0	0	0	0	0	0	0	0	0	
Railroad																		
Stopped Buses																		

Comments:

LOCATION: Stetson St -- California Ave
CITY/STATE: Moss Beach, CA

QC JOB #: 14384614
DATE: Thu, Apr 20 2017

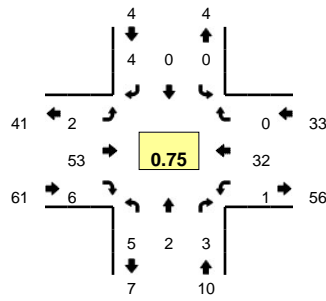

Peak-Hour: 4:30 PM -- 5:30 PM
Peak 15-Min: 5:15 PM -- 5:30 PM

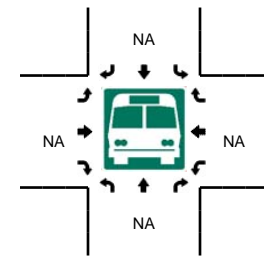
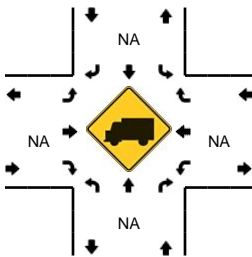
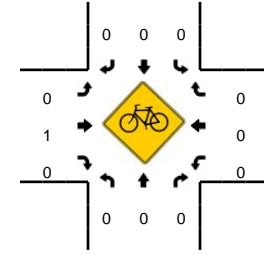
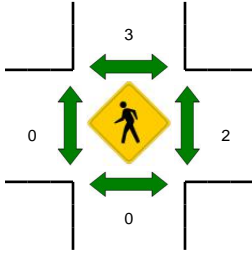
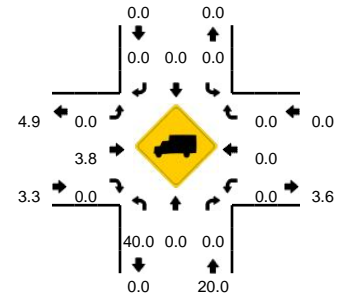

5-Min Count Period Beginning At	Stetson St (Northbound)				Stetson St (Southbound)				California Ave (Eastbound)				California Ave (Westbound)				Total	Hourly Totals
	Left	Thru	Right	U	Left	Thru	Right	U	Left	Thru	Right	U	Left	Thru	Right	U		
4:00 PM	0	0	0	0	0	0	1	0	3	6	0	0	0	1	0	0	11	
4:05 PM	0	0	0	0	0	1	1	0	0	5	0	0	0	3	0	0	10	
4:10 PM	0	0	0	0	0	0	0	0	0	1	0	0	0	2	0	0	3	
4:15 PM	1	1	0	0	0	0	0	0	0	6	0	0	0	1	0	0	9	
4:20 PM	0	0	0	0	0	0	0	0	1	2	0	0	0	2	0	0	5	
4:25 PM	0	0	0	0	0	0	0	0	0	1	0	0	0	1	5	0	7	
4:30 PM	1	1	0	0	0	0	1	0	1	2	0	0	0	0	3	0	9	
4:35 PM	0	0	0	0	0	0	1	0	0	3	0	0	0	2	0	0	6	
4:40 PM	1	0	0	0	0	0	0	0	0	2	0	0	0	2	0	0	5	
4:45 PM	0	0	0	0	0	0	0	0	0	5	1	0	0	2	0	0	8	
4:50 PM	1	0	1	0	0	0	1	0	0	7	1	0	1	2	0	0	14	
4:55 PM	0	0	1	0	0	0	0	0	0	3	0	0	0	1	0	0	5	92
5:00 PM	0	1	0	0	0	0	0	0	1	5	1	0	0	3	0	0	11	92
5:05 PM	0	0	0	0	0	0	0	0	0	6	0	0	0	2	0	0	8	90
5:10 PM	0	0	0	0	0	0	0	0	0	4	1	0	0	1	0	0	6	93
5:15 PM	1	0	0	0	0	0	0	0	0	5	2	0	0	4	0	0	12	96
5:20 PM	1	0	1	0	0	0	1	0	0	2	0	0	0	6	0	0	11	102
5:25 PM	0	0	0	0	0	0	0	0	0	9	0	0	0	4	0	0	13	108
5:30 PM	0	0	0	0	0	0	0	0	1	3	0	0	1	0	0	0	5	104
5:35 PM	0	0	0	0	0	0	0	0	0	3	0	0	0	0	0	0	3	101
5:40 PM	1	0	0	0	0	0	0	0	0	2	0	0	0	2	0	0	5	101
5:45 PM	0	0	0	0	0	0	0	0	0	8	0	0	0	3	0	0	11	104
5:50 PM	0	0	1	0	0	0	2	0	1	4	0	0	0	1	0	0	9	99
5:55 PM	0	0	0	0	0	0	0	0	0	2	0	0	0	2	0	0	4	98
Peak 15-Min Flowrates	Northbound				Southbound				Eastbound				Westbound				Total	
	Left	Thru	Right	U	Left	Thru	Right	U	Left	Thru	Right	U	Left	Thru	Right	U		
All Vehicles	8	0	4	0	0	0	4	0	0	64	8	0	0	56	0	0	144	
Heavy Trucks	8	0	0	0	0	0	0	0	0	4	0	0	0	0	0	0	12	
Pedestrians	0	0	0	0	0	0	0	0	0	0	0	0	0	8	0	0	8	
Bicycles	0	0	0	0	0	0	0	0	0	1	0	0	0	0	0	0	1	
Railroad																		
Stopped Buses																		

Comments:

LOCATION: Stetson St -- California Ave
CITY/STATE: Moss Beach, CA

QC JOB #: 14384615
DATE: Sat, Apr 22 2017

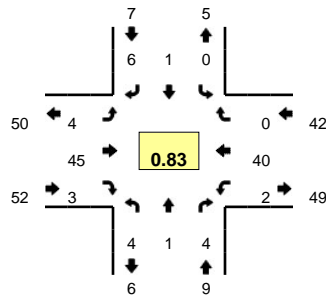

Peak-Hour: 11:10 AM -- 12:10 PM
Peak 15-Min: 11:35 AM -- 11:50 AM

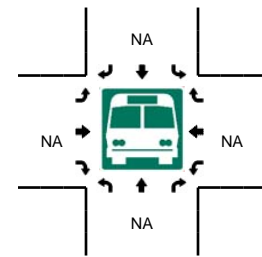
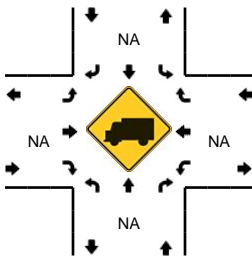
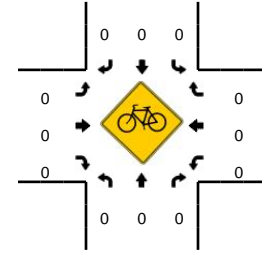
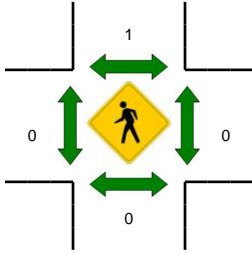
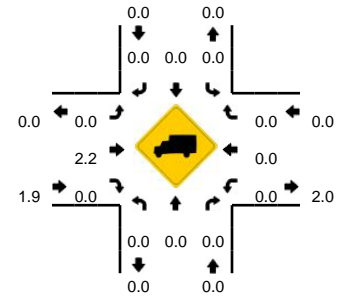

5-Min Count Period Beginning At	Stetson St (Northbound)				Stetson St (Southbound)				California Ave (Eastbound)				California Ave (Westbound)				Total	Hourly Totals	
	Left	Thru	Right	U	Left	Thru	Right	U	Left	Thru	Right	U	Left	Thru	Right	U			
11:00 AM	0	0	0	0	0	0	1	0	1	1	0	0	0	0	0	0	3		
11:05 AM	0	0	1	0	0	0	0	0	0	3	0	0	0	0	1	0	0	5	
11:10 AM	0	0	1	0	0	0	1	0	0	3	0	0	0	0	6	0	0	11	
11:15 AM	1	0	0	0	0	0	0	0	1	4	0	0	0	0	1	0	0	7	
11:20 AM	0	0	1	0	0	0	0	0	0	6	0	0	0	0	4	0	0	11	
11:25 AM	1	0	0	0	0	0	1	0	0	3	0	0	0	0	2	0	0	7	
11:30 AM	0	0	0	0	0	0	1	0	0	1	0	0	0	1	1	0	0	4	
11:35 AM	0	0	0	0	0	0	3	0	2	5	0	0	0	0	4	0	0	14	
11:40 AM	1	0	1	0	0	0	0	0	1	5	0	0	0	0	3	0	0	11	
11:45 AM	1	0	0	0	0	1	0	0	0	2	1	0	0	0	3	0	0	8	
11:50 AM	0	1	1	0	0	0	0	0	0	5	0	0	0	0	3	0	0	10	
11:55 AM	0	0	0	0	0	0	0	0	0	5	0	0	0	0	4	0	0	9	100
12:00 PM	0	0	0	0	0	0	0	0	0	3	1	0	0	1	4	0	0	9	106
12:05 PM	0	0	0	0	0	0	0	0	0	3	1	0	0	0	5	0	0	9	110
12:10 PM	1	0	0	0	0	0	0	0	0	3	0	0	0	0	3	0	0	7	106
12:15 PM	0	0	0	0	0	0	1	0	0	4	0	0	0	0	2	0	0	7	106
12:20 PM	0	0	0	0	0	0	0	0	0	3	0	0	0	0	3	0	0	6	101
12:25 PM	1	0	1	0	0	0	0	0	1	5	0	0	0	0	5	0	0	13	107
12:30 PM	0	0	0	0	0	0	0	0	0	2	1	0	0	0	2	0	0	5	108
12:35 PM	0	0	0	0	0	0	0	0	0	3	1	0	0	0	3	0	0	7	101
12:40 PM	0	0	0	0	0	0	0	0	0	7	0	0	0	0	6	0	0	13	103
12:45 PM	0	0	0	0	0	0	0	0	1	4	0	0	0	0	3	0	0	8	103
12:50 PM	0	0	0	0	0	0	0	0	1	2	0	0	0	0	3	0	0	6	99
12:55 PM	0	0	0	0	0	0	0	0	0	1	0	0	0	0	0	0	0	1	91
Peak 15-Min Flowrates	Northbound				Southbound				Eastbound				Westbound				Total		
	Left	Thru	Right	U	Left	Thru	Right	U	Left	Thru	Right	U	Left	Thru	Right	U			
All Vehicles	8	0	4	0	0	4	12	0	12	48	4	0	0	40	0	0	132		
Heavy Trucks	0	0	0	0	0	0	0	0	0	0	0	0	0	0	0	0	0		
Pedestrians	0	0	0	0	0	4	0	0	0	0	0	0	0	0	0	0	4		
Bicycles	0	0	0	0	0	0	0	0	0	0	0	0	0	0	0	0	0		
Railroad																			
Stopped Buses																			

Comments:

Appendix 3
Seasonal Adjustment
Methodology for Existing
Conditions

Mike Alston

From: Nowinski, Bill@DOT <bill.nowinski@dot.ca.gov>
Sent: Monday, October 23, 2017 9:20 AM
To: Mike Alston; Pribyl, Cindy L@DOT
Cc: Aaron Elias
Subject: RE: Highway 1 Peak Month ADT

Hello Mike,

The method you described would get you the best estimate for this area. Due to road closures due to fires and flooding our data is based on estimates from the surrounding areas. The ratio should give you the best results.

Bill Nowinski
Caltrans, District 5
Traffic Census-south
805-748-4437

From: Mike Alston [<mailto:malston@kittelson.com>]
Sent: Friday, October 20, 2017 12:56 PM
To: Pribyl, Cindy L@DOT <cindy.pribyl@dot.ca.gov>
Cc: Aaron Elias <aelias@kittelson.com>; Nowinski, Bill@DOT <bill.nowinski@dot.ca.gov>
Subject: RE: Highway 1 Peak Month ADT

Great, thank you Cindy.

Mike Alston
Transportation Analyst

[Kittelson & Associates, Inc.](#)
Transportation Engineering / Planning
510.433.8076 (direct)

From: Pribyl, Cindy L@DOT [<mailto:cindy.pribyl@dot.ca.gov>]
Sent: Friday, October 20, 2017 12:49 PM
To: Mike Alston
Cc: Aaron Elias; Nowinski, Bill@DOT
Subject: RE: Highway 1 Peak Month ADT

Hi Mike

I am forwarding your email to the Caltrans local District 5 Traffic Census Staff member Bill Nowinski. I am not familiar with this area's traffic patterns.

Bill is out in the field most days, but he does check his email account.

From: Mike Alston [<mailto:malston@kittelton.com>]
Sent: Friday, October 20, 2017 12:45 PM
To: Pribyl, Cindy L@DOT <cindy.pribyl@dot.ca.gov>
Cc: Aaron Elias <aalias@kittelton.com>
Subject: Highway 1 Peak Month ADT

Hi Cindy,

I am working on a transportation impact study in Moss Beach, California and am hoping you can provide me with some context on what's available on the Caltrans website.

Specifically, I am looking at the PDF "2015 Traffic Volumes on California State Highways."
(http://www.dot.ca.gov/trafficops/census/docs/2015_aadt_volumes.pdf)

For this project, Kittelson & Associates has Highway 1 traffic counts conducted in April 2017 but have been advised that we should find a conversion factor to represent the peak summer conditions. Based on what's in the PDF, I suspect our best option currently would be to use a ratio between **AADT** and the **Peak Month** to inflate them. (our counts as AADT, and our desired summer count number as peak month).

I am writing to ask you if you have any more granular information—specific months, for example, or any other seasonal/time trend related data. In particular, I am looking at SR1 in Caltrans District 4, San Mateo County, and the Vallemar/Etheldore Streets location (postmile 35.334).

Any guidance or more detailed information you could provide in this matter would be greatly appreciated.

Thank you,
Mike Alston

Mike Alston
Transportation Analyst

[Kittelson & Associates, Inc.](#)
Transportation Engineering / Planning
155 Grand Avenue, Suite 900
Oakland, California 94612
510.839.1742
510.433.8076 (direct)



[Streetwise](#) [Twitter](#) [Facebook](#)

Appendix 4 Existing Conditions Level-of-Service Worksheets

Intersection

Int Delay, s/veh 0.4

Movement	WBL	WBR	NBT	NBR	SBL	SBT
Lane Configurations	↘↙		↑	↗		↖
Traffic Vol, veh/h	14	7	679	15	1	567
Future Vol, veh/h	14	7	679	15	1	567
Conflicting Peds, #/hr	0	0	0	0	0	0
Sign Control	Stop	Stop	Free	Free	Free	Free
RT Channelized	-	None	-	None	-	None
Storage Length	0	-	-	125	-	-
Veh in Median Storage, #	0	-	0	-	-	0
Grade, %	0	-	0	-	-	0
Peak Hour Factor	92	92	92	92	92	92
Heavy Vehicles, %	0	0	6	0	0	4
Mvmt Flow	15	8	738	16	1	616

Major/Minor	Minor1		Major1		Major2	
Conflicting Flow All	1356	738	0	0	738	0
Stage 1	738	-	-	-	-	-
Stage 2	618	-	-	-	-	-
Critical Hdwy	6.4	6.2	-	-	4.1	-
Critical Hdwy Stg 1	5.4	-	-	-	-	-
Critical Hdwy Stg 2	5.4	-	-	-	-	-
Follow-up Hdwy	3.5	3.3	-	-	2.2	-
Pot Cap-1 Maneuver	166	421	-	-	877	-
Stage 1	476	-	-	-	-	-
Stage 2	542	-	-	-	-	-
Platoon blocked, %			-	-		
Mov Cap-1 Maneuver	166	421	-	-	877	-
Mov Cap-2 Maneuver	166	-	-	-	-	-
Stage 1	476	-	-	-	-	-
Stage 2	541	-	-	-	-	-

Approach	WB		NB		SB
HCM Control Delay, s	24.4		0		0
HCM LOS	C				

Minor Lane/Major Mvmt	NBT	NBRWBLn1	SBL	SBT
Capacity (veh/h)	-	-	208	877
HCM Lane V/C Ratio	-	-	0.11	0.001
HCM Control Delay (s)	-	-	24.4	9.1
HCM Lane LOS	-	-	C	A
HCM 95th %tile Q(veh)	-	-	0.4	0

Intersection

Int Delay, s/veh 0.1

Movement	EBL	EBT	EBR	WBL	WBT	WBR	NBL	NBT	NBR	SBL	SBT	SBR
Lane Configurations		↔			↔		↑	↑		↑	↑	
Traffic Vol, veh/h	4	0	1	0	0	0	0	684	0	0	593	4
Future Vol, veh/h	4	0	1	0	0	0	0	684	0	0	593	4
Conflicting Peds, #/hr	1	0	0	0	0	1	1	0	1	1	0	1
Sign Control	Stop	Stop	Stop	Stop	Stop	Stop	Free	Free	Free	Free	Free	Free
RT Channelized	-	-	None	-	-	None	-	-	None	-	-	None
Storage Length	-	-	-	-	-	-	65	-	-	50	-	-
Veh in Median Storage, #	-	0	-	-	0	-	-	0	-	-	0	-
Grade, %	-	0	-	-	0	-	-	0	-	-	0	-
Peak Hour Factor	93	93	93	93	93	93	93	93	93	93	93	93
Heavy Vehicles, %	0	0	0	0	0	0	0	6	0	0	4	0
Mvmt Flow	4	0	1	0	0	0	0	735	0	0	638	4

Major/Minor	Minor2			Minor1			Major1			Major2		
Conflicting Flow All	1377	1377	641	1376	1379	737	643	0	0	736	0	0
Stage 1	641	641	-	736	736	-	-	-	-	-	-	-
Stage 2	736	736	-	640	643	-	-	-	-	-	-	-
Critical Hdwy	7.1	6.5	6.2	7.1	6.5	6.2	4.1	-	-	4.1	-	-
Critical Hdwy Stg 1	6.1	5.5	-	6.1	5.5	-	-	-	-	-	-	-
Critical Hdwy Stg 2	6.1	5.5	-	6.1	5.5	-	-	-	-	-	-	-
Follow-up Hdwy	3.5	4	3.3	3.5	4	3.3	2.2	-	-	2.2	-	-
Pot Cap-1 Maneuver	123	146	478	124	146	422	951	-	-	879	-	-
Stage 1	466	473	-	414	428	-	-	-	-	-	-	-
Stage 2	414	428	-	467	472	-	-	-	-	-	-	-
Platoon blocked, %												
Mov Cap-1 Maneuver	123	146	478	124	146	421	951	-	-	878	-	-
Mov Cap-2 Maneuver	123	146	-	124	146	-	-	-	-	-	-	-
Stage 1	466	473	-	414	428	-	-	-	-	-	-	-
Stage 2	414	428	-	466	472	-	-	-	-	-	-	-

Approach	EB	WB	NB	SB
HCM Control Delay, s	31	0	0	0
HCM LOS	D	A		

Minor Lane/Major Mvmt	NBL	NBT	NBR	EBLn1	WBLn1	SBL	SBT	SBR
Capacity (veh/h)	951	-	-	144	-	878	-	-
HCM Lane V/C Ratio	-	-	-	0.037	-	-	-	-
HCM Control Delay (s)	0	-	-	31	0	0	-	-
HCM Lane LOS	A	-	-	D	A	A	-	-
HCM 95th %tile Q(veh)	0	-	-	0.1	-	0	-	-

Intersection

Int Delay, s/veh 0.3

Movement	WBL	WBR	NBT	NBR	SBL	SBT
Lane Configurations	Y		P		T	T
Traffic Vol, veh/h	0	23	658	0	5	582
Future Vol, veh/h	0	23	658	0	5	582
Conflicting Peds, #/hr	0	0	0	0	0	0
Sign Control	Stop	Stop	Free	Free	Free	Free
RT Channelized	-	None	-	None	-	None
Storage Length	0	-	-	-	65	-
Veh in Median Storage, #	0	-	0	-	-	0
Grade, %	0	-	0	-	-	0
Peak Hour Factor	92	92	92	92	92	92
Heavy Vehicles, %	0	0	6	0	0	4
Mvmt Flow	0	25	715	0	5	633

Major/Minor	Minor1		Major1		Major2	
Conflicting Flow All	1358	715	0	0	715	0
Stage 1	715	-	-	-	-	-
Stage 2	643	-	-	-	-	-
Critical Hdwy	6.4	6.2	-	-	4.1	-
Critical Hdwy Stg 1	5.4	-	-	-	-	-
Critical Hdwy Stg 2	5.4	-	-	-	-	-
Follow-up Hdwy	3.5	3.3	-	-	2.2	-
Pot Cap-1 Maneuver	166	434	-	-	895	-
Stage 1	488	-	-	-	-	-
Stage 2	527	-	-	-	-	-
Platoon blocked, %			-	-		
Mov Cap-1 Maneuver	165	434	-	-	895	-
Mov Cap-2 Maneuver	165	-	-	-	-	-
Stage 1	488	-	-	-	-	-
Stage 2	524	-	-	-	-	-

Approach	WB		NB		SB
HCM Control Delay, s	13.8		0		0.1
HCM LOS	B				

Minor Lane/Major Mvmt	NBT	NBRWBLn1	SBL	SBT
Capacity (veh/h)	-	- 434	895	-
HCM Lane V/C Ratio	-	- 0.058	0.006	-
HCM Control Delay (s)	-	- 13.8	9	-
HCM Lane LOS	-	- B	A	-
HCM 95th %tile Q(veh)	-	- 0.2	0	-

Intersection

Int Delay, s/veh 7.6

Movement	WBL	WBR	NBT	NBR	SBL	SBT
Lane Configurations	Y		P			A
Traffic Vol, veh/h	1	22	1	0	5	1
Future Vol, veh/h	1	22	1	0	5	1
Conflicting Peds, #/hr	0	0	0	0	0	0
Sign Control	Stop	Stop	Free	Free	Free	Free
RT Channelized	-	None	-	None	-	None
Storage Length	0	-	-	-	-	-
Veh in Median Storage, #	0	-	0	-	-	0
Grade, %	0	-	0	-	-	0
Peak Hour Factor	75	75	75	75	75	75
Heavy Vehicles, %	0	0	0	0	0	0
Mvmt Flow	1	29	1	0	7	1

Major/Minor	Minor1		Major1		Major2	
Conflicting Flow All	16	1	0	0	1	0
Stage 1	1	-	-	-	-	-
Stage 2	15	-	-	-	-	-
Critical Hdwy	6.4	6.2	-	-	4.1	-
Critical Hdwy Stg 1	5.4	-	-	-	-	-
Critical Hdwy Stg 2	5.4	-	-	-	-	-
Follow-up Hdwy	3.5	3.3	-	-	2.2	-
Pot Cap-1 Maneuver	1008	1090	-	-	1635	-
Stage 1	1028	-	-	-	-	-
Stage 2	1013	-	-	-	-	-
Platoon blocked, %			-	-		-
Mov Cap-1 Maneuver	1004	1090	-	-	1635	-
Mov Cap-2 Maneuver	1004	-	-	-	-	-
Stage 1	1028	-	-	-	-	-
Stage 2	1009	-	-	-	-	-

Approach	WB		NB		SB
HCM Control Delay, s	8.4		0		6
HCM LOS	A				

Minor Lane/Major Mvmt	NBT	NBRWBLn1	SBL	SBT
Capacity (veh/h)	-	- 1086	1635	-
HCM Lane V/C Ratio	-	- 0.028	0.004	-
HCM Control Delay (s)	-	- 8.4	7.2	0
HCM Lane LOS	-	- A	A	A
HCM 95th %tile Q(veh)	-	- 0.1	0	-

Intersection

Int Delay, s/veh 5.7

Movement	EBT	EBR	WBL	WBT	NBL	NBR
Lane Configurations	↔		↔		↔	
Traffic Vol, veh/h	2	3	0	4	18	0
Future Vol, veh/h	2	3	0	4	18	0
Conflicting Peds, #/hr	0	0	0	0	0	1
Sign Control	Free	Free	Free	Free	Stop	Stop
RT Channelized	-	None	-	None	-	None
Storage Length	-	-	-	-	0	-
Veh in Median Storage, #	0	-	-	0	0	-
Grade, %	0	-	-	0	0	-
Peak Hour Factor	70	70	70	70	70	70
Heavy Vehicles, %	0	0	0	0	0	0
Mvmt Flow	3	4	0	6	26	0

Major/Minor	Major1		Major2		Minor1	
Conflicting Flow All	0	0	7	0	11	6
Stage 1	-	-	-	-	5	-
Stage 2	-	-	-	-	6	-
Critical Hdwy	-	-	4.1	-	6.4	6.2
Critical Hdwy Stg 1	-	-	-	-	5.4	-
Critical Hdwy Stg 2	-	-	-	-	5.4	-
Follow-up Hdwy	-	-	2.2	-	3.5	3.3
Pot Cap-1 Maneuver	-	-	1627	-	1014	1083
Stage 1	-	-	-	-	1023	-
Stage 2	-	-	-	-	1022	-
Platoon blocked, %	-	-	-	-	-	-
Mov Cap-1 Maneuver	-	-	1625	-	1014	1082
Mov Cap-2 Maneuver	-	-	-	-	1014	-
Stage 1	-	-	-	-	1023	-
Stage 2	-	-	-	-	1022	-

Approach	EB	WB	NB
HCM Control Delay, s	0	0	8.6
HCM LOS			A

Minor Lane/Major Mvmt	NBLn1	EBT	EBR	WBL	WBT
Capacity (veh/h)	1014	-	-	1625	-
HCM Lane V/C Ratio	0.025	-	-	-	-
HCM Control Delay (s)	8.6	-	-	0	-
HCM Lane LOS	A	-	-	A	-
HCM 95th %tile Q(veh)	0.1	-	-	0	-

Intersection

Int Delay, s/veh 0.6

Movement	EBL	EBT	EBR	WBL	WBT	WBR	NBL	NBT	NBR	SBL	SBT	SBR
Lane Configurations		↔			↔		↖	↗		↖	↗	
Traffic Vol, veh/h	3	0	5	2	0	26	4	631	4	10	565	0
Future Vol, veh/h	3	0	5	2	0	26	4	631	4	10	565	0
Conflicting Peds, #/hr	0	0	0	0	0	0	1	0	0	0	0	1
Sign Control	Stop	Stop	Stop	Stop	Stop	Stop	Free	Free	Free	Free	Free	Free
RT Channelized	-	-	None	-	-	None	-	-	None	-	-	None
Storage Length	-	-	-	-	-	-	125	-	-	125	-	-
Veh in Median Storage, #	-	0	-	-	0	-	-	0	-	-	0	-
Grade, %	-	0	-	-	0	-	-	0	-	-	0	-
Peak Hour Factor	90	90	90	90	90	90	90	90	90	90	90	90
Heavy Vehicles, %	0	0	0	0	0	4	0	6	0	0	4	0
Mvmt Flow	3	0	6	2	0	29	4	701	4	11	628	0

Major/Minor	Minor2			Minor1			Major1			Major2		
Conflicting Flow All	1378	1365	629	1365	1363	703	629	0	0	706	0	0
Stage 1	651	651	-	712	712	-	-	-	-	-	-	-
Stage 2	727	714	-	653	651	-	-	-	-	-	-	-
Critical Hdwy	7.1	6.5	6.2	7.1	6.5	6.24	4.1	-	-	4.1	-	-
Critical Hdwy Stg 1	6.1	5.5	-	6.1	5.5	-	-	-	-	-	-	-
Critical Hdwy Stg 2	6.1	5.5	-	6.1	5.5	-	-	-	-	-	-	-
Follow-up Hdwy	3.5	4	3.3	3.5	4	3.336	2.2	-	-	2.2	-	-
Pot Cap-1 Maneuver	123	149	486	126	149	434	963	-	-	902	-	-
Stage 1	461	468	-	427	439	-	-	-	-	-	-	-
Stage 2	419	438	-	460	468	-	-	-	-	-	-	-
Platoon blocked, %												
Mov Cap-1 Maneuver	113	146	486	123	146	434	963	-	-	902	-	-
Mov Cap-2 Maneuver	113	146	-	123	146	-	-	-	-	-	-	-
Stage 1	459	462	-	425	437	-	-	-	-	-	-	-
Stage 2	389	436	-	449	462	-	-	-	-	-	-	-

Approach	EB	WB	NB	SB
HCM Control Delay, s	22.3	15.7	0.1	0.2
HCM LOS	C	C		

Minor Lane/Major Mvmt	NBL	NBT	NBR	EBLn1WBLn1	SBL	SBT	SBR
Capacity (veh/h)	963	-	-	217 368	902	-	-
HCM Lane V/C Ratio	0.005	-	-	0.041 0.085	0.012	-	-
HCM Control Delay (s)	8.8	-	-	22.3 15.7	9	-	-
HCM Lane LOS	A	-	-	C C	A	-	-
HCM 95th %tile Q(veh)	0	-	-	0.1 0.3	0	-	-

Intersection

Int Delay, s/veh 2.6

Movement	EBL	EBT	EBR	WBL	WBT	WBR	NBL	NBT	NBR	SBL	SBT	SBR
Lane Configurations		↔			↔		↔	↔		↔	↔	
Traffic Vol, veh/h	10	0	11	48	0	15	4	619	21	6	561	6
Future Vol, veh/h	10	0	11	48	0	15	4	619	21	6	561	6
Conflicting Peds, #/hr	0	0	0	0	0	0	1	0	0	0	0	1
Sign Control	Stop	Stop	Stop	Stop	Stop	Stop	Free	Free	Free	Free	Free	Free
RT Channelized	-	-	None	-	-	None	-	-	None	-	-	None
Storage Length	-	-	-	-	-	-	80	-	-	125	-	-
Veh in Median Storage, #	-	0	-	-	0	-	-	0	-	-	0	-
Grade, %	-	0	-	-	0	-	-	0	-	-	0	-
Peak Hour Factor	93	93	93	93	93	93	93	93	93	93	93	93
Heavy Vehicles, %	2	2	2	2	2	2	2	2	2	2	2	2
Mvmt Flow	11	0	12	52	0	16	4	666	23	6	603	6

Major/Minor	Minor2			Minor1			Major1			Major2		
Conflicting Flow All	1314	1317	607	1310	1309	677	611	0	0	688	0	0
Stage 1	620	620	-	685	685	-	-	-	-	-	-	-
Stage 2	694	697	-	625	624	-	-	-	-	-	-	-
Critical Hdwy	7.12	6.52	6.22	7.12	6.52	6.22	4.12	-	-	4.12	-	-
Critical Hdwy Stg 1	6.12	5.52	-	6.12	5.52	-	-	-	-	-	-	-
Critical Hdwy Stg 2	6.12	5.52	-	6.12	5.52	-	-	-	-	-	-	-
Follow-up Hdwy	3.518	4.018	3.318	3.518	4.018	3.318	2.218	-	-	2.218	-	-
Pot Cap-1 Maneuver	135	157	496	136	159	453	968	-	-	906	-	-
Stage 1	476	480	-	438	448	-	-	-	-	-	-	-
Stage 2	433	443	-	473	478	-	-	-	-	-	-	-
Platoon blocked, %												
Mov Cap-1 Maneuver	129	155	496	132	157	453	968	-	-	906	-	-
Mov Cap-2 Maneuver	129	155	-	132	157	-	-	-	-	-	-	-
Stage 1	474	476	-	436	446	-	-	-	-	-	-	-
Stage 2	416	441	-	459	474	-	-	-	-	-	-	-

Approach	EB	WB	NB	SB
HCM Control Delay, s	24.1	43.5	0.1	0.1
HCM LOS	C	E		

Minor Lane/Major Mvmt	NBL	NBT	NBR	EBLn1	WBLn1	SBL	SBT	SBR
Capacity (veh/h)	968	-	-	211	159	906	-	-
HCM Lane V/C Ratio	0.004	-	-	0.107	0.426	0.007	-	-
HCM Control Delay (s)	8.7	-	-	24.1	43.5	9	-	-
HCM Lane LOS	A	-	-	C	E	A	-	-
HCM 95th %tile Q(veh)	0	-	-	0.4	1.9	0	-	-

Intersection

Int Delay, s/veh 1.6

Movement	EBL	EBT	EBR	WBL	WBT	WBR	NBL	NBT	NBR	SBL	SBT	SBR
Lane Configurations		↕			↕			↕			↕	
Traffic Vol, veh/h	6	16	0	1	65	0	3	2	0	2	2	3
Future Vol, veh/h	6	16	0	1	65	0	3	2	0	2	2	3
Conflicting Peds, #/hr	1	0	0	0	0	1	0	0	1	1	0	0
Sign Control	Free	Free	Free	Free	Free	Free	Stop	Stop	Stop	Stop	Stop	Stop
RT Channelized	-	-	None	-	-	None	-	-	None	-	-	None
Storage Length	-	-	-	-	-	-	-	-	-	-	-	-
Veh in Median Storage, #	-	0	-	-	0	-	-	0	-	-	0	-
Grade, %	-	0	-	-	0	-	-	0	-	-	0	-
Peak Hour Factor	74	74	74	74	74	74	74	74	74	74	74	74
Heavy Vehicles, %	0	0	0	0	0	0	33	0	0	0	0	0
Mvmt Flow	8	22	0	1	88	0	4	3	0	3	3	4

Major/Minor	Major1			Major2			Minor1			Minor2		
Conflicting Flow All	89	0	0	22	0	0	132	130	23	132	130	89
Stage 1	-	-	-	-	-	-	38	38	-	92	92	-
Stage 2	-	-	-	-	-	-	94	92	-	40	38	-
Critical Hdwy	4.1	-	-	4.1	-	-	7.43	6.5	6.2	7.1	6.5	6.2
Critical Hdwy Stg 1	-	-	-	-	-	-	6.43	5.5	-	6.1	5.5	-
Critical Hdwy Stg 2	-	-	-	-	-	-	6.43	5.5	-	6.1	5.5	-
Follow-up Hdwy	2.2	-	-	2.2	-	-	3.797	4	3.3	3.5	4	3.3
Pot Cap-1 Maneuver	1519	-	-	1607	-	-	773	764	1060	845	764	975
Stage 1	-	-	-	-	-	-	904	867	-	920	823	-
Stage 2	-	-	-	-	-	-	842	823	-	980	867	-
Platoon blocked, %		-	-		-	-						
Mov Cap-1 Maneuver	1519	-	-	1605	-	-	764	759	1059	837	759	974
Mov Cap-2 Maneuver	-	-	-	-	-	-	764	759	-	837	759	-
Stage 1	-	-	-	-	-	-	899	863	-	915	821	-
Stage 2	-	-	-	-	-	-	835	821	-	971	863	-

Approach	EB	WB	NB	SB
HCM Control Delay, s	2	0.1	9.8	9.2
HCM LOS			A	A

Minor Lane/Major Mvmt	NBLn1	EBL	EBT	EBR	WBL	WBT	WBR	SBLn1
Capacity (veh/h)	762	1519	-	-	1605	-	-	864
HCM Lane V/C Ratio	0.009	0.005	-	-	0.001	-	-	0.011
HCM Control Delay (s)	9.8	7.4	0	-	7.2	0	-	9.2
HCM Lane LOS	A	A	A	-	A	A	-	A
HCM 95th %tile Q(veh)	0	0	-	-	0	-	-	0

Intersection

Int Delay, s/veh 7.7

Movement	EBL	EBT	EBR	WBL	WBT	WBR	NBL	NBT	NBR	SBL	SBT	SBR
Lane Configurations		↕			↕			↕			↕	
Traffic Vol, veh/h	0	14	0	1	65	9	2	17	0	1	4	0
Future Vol, veh/h	0	14	0	1	65	9	2	17	0	1	4	0
Conflicting Peds, #/hr	1	0	0	0	0	1	0	0	0	0	0	0
Sign Control	Stop	Stop	Stop	Stop	Stop	Stop	Free	Free	Free	Free	Free	Free
RT Channelized	-	-	None	-	-	None	-	-	None	-	-	None
Storage Length	-	-	-	-	-	-	-	-	-	-	-	-
Veh in Median Storage, #	-	0	-	-	0	-	-	0	-	-	0	-
Grade, %	-	0	-	-	0	-	-	0	-	-	0	-
Peak Hour Factor	83	83	83	83	83	83	83	83	83	83	83	83
Heavy Vehicles, %	0	0	0	0	0	0	0	6	0	0	0	0
Mvmt Flow	0	17	0	1	78	11	2	20	0	1	5	0

Major/Minor	Minor2			Minor1			Major1			Major2		
Conflicting Flow All	78	32	5	41	32	21	5	0	0	20	0	0
Stage 1	7	7	-	25	25	-	-	-	-	-	-	-
Stage 2	71	25	-	16	7	-	-	-	-	-	-	-
Critical Hdwy	7.1	6.5	6.2	7.1	6.5	6.2	4.1	-	-	4.1	-	-
Critical Hdwy Stg 1	6.1	5.5	-	6.1	5.5	-	-	-	-	-	-	-
Critical Hdwy Stg 2	6.1	5.5	-	6.1	5.5	-	-	-	-	-	-	-
Follow-up Hdwy	3.5	4	3.3	3.5	4	3.3	2.2	-	-	2.2	-	-
Pot Cap-1 Maneuver	916	865	1084	968	865	1062	1630	-	-	1609	-	-
Stage 1	1020	894	-	998	878	-	-	-	-	-	-	-
Stage 2	944	878	-	1009	894	-	-	-	-	-	-	-
Platoon blocked, %												
Mov Cap-1 Maneuver	842	863	1084	952	863	1061	1630	-	-	1607	-	-
Mov Cap-2 Maneuver	842	863	-	952	863	-	-	-	-	-	-	-
Stage 1	1019	893	-	997	877	-	-	-	-	-	-	-
Stage 2	849	877	-	989	893	-	-	-	-	-	-	-

Approach	EB	WB	NB	SB
HCM Control Delay, s	9.3	9.5	0.8	1.4
HCM LOS	A	A		

Minor Lane/Major Mvmt	NBL	NBT	NBR	EBLn1WBLn1	SBL	SBT	SBR
Capacity (veh/h)	1630	-	-	863 884	1607	-	-
HCM Lane V/C Ratio	0.001	-	-	0.02 0.102	0.001	-	-
HCM Control Delay (s)	7.2	0	-	9.3 9.5	7.2	0	-
HCM Lane LOS	A	A	-	A A	A	A	-
HCM 95th %tile Q(veh)	0	-	-	0.1 0.3	0	-	-

Intersection	
Intersection Delay, s/veh	7.2
Intersection LOS	A

Movement	EBU	EBL	EBT	EBR	WBU	WBL	WBT	WBR	NBU	NBL	NBT	NBR
Lane Configurations			↕				↕				↕	
Traffic Vol, veh/h	0	0	17	1	0	5	63	1	0	1	1	2
Future Vol, veh/h	0	0	17	1	0	5	63	1	0	1	1	2
Peak Hour Factor	0.92	0.90	0.90	0.90	0.92	0.90	0.90	0.90	0.92	0.90	0.90	0.90
Heavy Vehicles, %	2	0	6	0	2	0	0	0	2	0	0	0
Mvmt Flow	0	0	19	1	0	6	70	1	0	1	1	2
Number of Lanes	0	0	1	0	0	0	1	0	0	0	1	0

Approach	EB	WB	NB
Opposing Approach	WB	EB	SB
Opposing Lanes	1	1	1
Conflicting Approach Left	SB	NB	EB
Conflicting Lanes Left	1	1	1
Conflicting Approach Right	NB	SB	WB
Conflicting Lanes Right	1	1	1
HCM Control Delay	7.2	7.3	6.9
HCM LOS	A	A	A

Lane	NBLn1	EBLn1	WBLn1	SBLn1
Vol Left, %	25%	0%	7%	0%
Vol Thru, %	25%	94%	91%	0%
Vol Right, %	50%	6%	1%	100%
Sign Control	Stop	Stop	Stop	Stop
Traffic Vol by Lane	4	18	69	6
LT Vol	1	0	5	0
Through Vol	1	17	63	0
RT Vol	2	1	1	6
Lane Flow Rate	4	20	77	7
Geometry Grp	1	1	1	1
Degree of Util (X)	0.005	0.022	0.084	0.006
Departure Headway (Hd)	3.823	4.045	3.94	3.47
Convergence, Y/N	Yes	Yes	Yes	Yes
Cap	932	887	913	1026
Service Time	1.861	2.061	1.946	1.51
HCM Lane V/C Ratio	0.004	0.023	0.084	0.007
HCM Control Delay	6.9	7.2	7.3	6.5
HCM Lane LOS	A	A	A	A
HCM 95th-tile Q	0	0.1	0.3	0

Intersection

Intersection Delay, s/veh

Intersection LOS

Movement	SBU	SBL	SBT	SBR
Lane Configurations			↕	
Traffic Vol, veh/h	0	0	0	6
Future Vol, veh/h	0	0	0	6
Peak Hour Factor	0.92	0.90	0.90	0.90
Heavy Vehicles, %	2	0	0	0
Mvmt Flow	0	0	0	7
Number of Lanes	0	0	1	0

Approach SB

Opposing Approach	NB
Opposing Lanes	1
Conflicting Approach Left	WB
Conflicting Lanes Left	1
Conflicting Approach Right	EB
Conflicting Lanes Right	1
HCM Control Delay	6.5
HCM LOS	A

Intersection

Int Delay, s/veh 0.2

Movement	EBL	EBR	NBL	NBT	SBT	SBR
Lane Configurations	Y			Y	Y	
Traffic Vol, veh/h	3	6	7	638	567	0
Future Vol, veh/h	3	6	7	638	567	0
Conflicting Peds, #/hr	0	0	1	0	0	1
Sign Control	Stop	Stop	Free	Free	Free	Free
RT Channelized	-	None	-	None	-	None
Storage Length	0	-	-	-	-	-
Veh in Median Storage, #	0	-	-	0	0	-
Grade, %	0	-	-	0	0	-
Peak Hour Factor	93	93	93	93	93	93
Heavy Vehicles, %	2	2	2	2	2	2
Mvmt Flow	3	6	8	686	610	0

Major/Minor	Minor2	Major1		Major2	
Conflicting Flow All	1312	611	611	0	0
Stage 1	611	-	-	-	-
Stage 2	701	-	-	-	-
Critical Hdwy	6.42	6.22	4.12	-	-
Critical Hdwy Stg 1	5.42	-	-	-	-
Critical Hdwy Stg 2	5.42	-	-	-	-
Follow-up Hdwy	3.518	3.318	2.218	-	-
Pot Cap-1 Maneuver	175	494	968	-	-
Stage 1	542	-	-	-	-
Stage 2	492	-	-	-	-
Platoon blocked, %				-	-
Mov Cap-1 Maneuver	172	494	968	-	-
Mov Cap-2 Maneuver	172	-	-	-	-
Stage 1	541	-	-	-	-
Stage 2	485	-	-	-	-

Approach	EB	NB	SB
HCM Control Delay, s	17.2	0.1	0
HCM LOS	C		

Minor Lane/Major Mvmt	NBL	NBT	EBLn1	SBT	SBR
Capacity (veh/h)	968	-	304	-	-
HCM Lane V/C Ratio	0.008	-	0.032	-	-
HCM Control Delay (s)	8.7	0	17.2	-	-
HCM Lane LOS	A	A	C	-	-
HCM 95th %tile Q(veh)	0	-	0.1	-	-

Intersection

Int Delay, s/veh 0.4

Movement	WBL	WBR	NBT	NBR	SBL	SBT
Lane Configurations	↘↙		↑	↗		↖
Traffic Vol, veh/h	11	5	671	18	5	862
Future Vol, veh/h	11	5	671	18	5	862
Conflicting Peds, #/hr	0	0	0	1	1	0
Sign Control	Stop	Stop	Free	Free	Free	Free
RT Channelized	-	None	-	None	-	None
Storage Length	0	-	-	125	-	-
Veh in Median Storage, #	0	-	0	-	-	0
Grade, %	0	-	0	-	-	0
Peak Hour Factor	95	95	95	95	95	95
Heavy Vehicles, %	0	0	2	0	0	2
Mvmt Flow	12	5	706	19	5	907

Major/Minor	Minor1		Major1		Major2	
Conflicting Flow All	1625	707	0	0	707	0
Stage 1	707	-	-	-	-	-
Stage 2	918	-	-	-	-	-
Critical Hdwy	6.4	6.2	-	-	4.1	-
Critical Hdwy Stg 1	5.4	-	-	-	-	-
Critical Hdwy Stg 2	5.4	-	-	-	-	-
Follow-up Hdwy	3.5	3.3	-	-	2.2	-
Pot Cap-1 Maneuver	114	439	-	-	901	-
Stage 1	493	-	-	-	-	-
Stage 2	392	-	-	-	-	-
Platoon blocked, %			-	-		
Mov Cap-1 Maneuver	113	439	-	-	901	-
Mov Cap-2 Maneuver	113	-	-	-	-	-
Stage 1	493	-	-	-	-	-
Stage 2	388	-	-	-	-	-

Approach	WB		NB		SB
HCM Control Delay, s	32.6		0		0.1
HCM LOS	D				

Minor Lane/Major Mvmt	NBT	NBRWBLn1	SBL	SBT
Capacity (veh/h)	-	- 147	901	-
HCM Lane V/C Ratio	-	- 0.115	0.006	-
HCM Control Delay (s)	-	- 32.6	9	0
HCM Lane LOS	-	- D	A	A
HCM 95th %tile Q(veh)	-	- 0.4	0	-

Intersection

Int Delay, s/veh 0.3

Movement	EBL	EBT	EBR	WBL	WBT	WBR	NBL	NBT	NBR	SBL	SBT	SBR
Lane Configurations		↔			↔		↑	↑		↑	↑	
Traffic Vol, veh/h	5	0	4	1	0	2	0	683	0	1	858	4
Future Vol, veh/h	5	0	4	1	0	2	0	683	0	1	858	4
Conflicting Peds, #/hr	5	0	0	0	0	5	0	0	4	4	0	0
Sign Control	Stop	Stop	Stop	Stop	Stop	Stop	Free	Free	Free	Free	Free	Free
RT Channelized	-	-	None	-	-	None	-	-	None	-	-	None
Storage Length	-	-	-	-	-	-	65	-	-	50	-	-
Veh in Median Storage, #	-	0	-	-	0	-	-	0	-	-	0	-
Grade, %	-	0	-	-	0	-	-	0	-	-	0	-
Peak Hour Factor	94	94	94	94	94	94	94	94	94	94	94	94
Heavy Vehicles, %	0	0	0	0	0	0	0	2	0	0	1	0
Mvmt Flow	5	0	4	1	0	2	0	727	0	1	913	4

Major/Minor	Minor2			Minor1			Major1			Major2		
Conflicting Flow All	1650	1648	915	1650	1650	736	917	0	0	731	0	0
Stage 1	917	917	-	731	731	-	-	-	-	-	-	-
Stage 2	733	731	-	919	919	-	-	-	-	-	-	-
Critical Hdwy	7.1	6.5	6.2	7.1	6.5	6.2	4.1	-	-	4.1	-	-
Critical Hdwy Stg 1	6.1	5.5	-	6.1	5.5	-	-	-	-	-	-	-
Critical Hdwy Stg 2	6.1	5.5	-	6.1	5.5	-	-	-	-	-	-	-
Follow-up Hdwy	3.5	4	3.3	3.5	4	3.3	2.2	-	-	2.2	-	-
Pot Cap-1 Maneuver	80	100	333	80	100	422	752	-	-	883	-	-
Stage 1	329	354	-	416	430	-	-	-	-	-	-	-
Stage 2	415	430	-	328	353	-	-	-	-	-	-	-
Platoon blocked, %												
Mov Cap-1 Maneuver	79	100	333	79	100	418	752	-	-	879	-	-
Mov Cap-2 Maneuver	79	100	-	79	100	-	-	-	-	-	-	-
Stage 1	329	354	-	414	428	-	-	-	-	-	-	-
Stage 2	411	428	-	323	353	-	-	-	-	-	-	-

Approach	EB	WB	NB	SB
HCM Control Delay, s	37.6	26.3	0	0
HCM LOS	E	D		

Minor Lane/Major Mvmt	NBL	NBT	NBR	EBLn1WBLn1	SBL	SBT	SBR
Capacity (veh/h)	752	-	-	120 172	879	-	-
HCM Lane V/C Ratio	-	-	-	0.08 0.019	0.001	-	-
HCM Control Delay (s)	0	-	-	37.6 26.3	9.1	-	-
HCM Lane LOS	A	-	-	E D	A	-	-
HCM 95th %tile Q(veh)	0	-	-	0.3 0.1	0	-	-

Intersection

Int Delay, s/veh 0.2

Movement	WBL	WBR	NBT	NBR	SBL	SBT
Lane Configurations	Y		P		T	T
Traffic Vol, veh/h	0	5	678	0	18	851
Future Vol, veh/h	0	5	678	0	18	851
Conflicting Peds, #/hr	0	0	0	2	2	0
Sign Control	Stop	Stop	Free	Free	Free	Free
RT Channelized	-	None	-	None	-	None
Storage Length	0	-	-	-	65	-
Veh in Median Storage, #	0	-	0	-	-	0
Grade, %	0	-	0	-	-	0
Peak Hour Factor	96	96	96	96	96	96
Heavy Vehicles, %	0	0	2	0	0	2
Mvmt Flow	0	5	706	0	19	886

Major/Minor	Minor1		Major1		Major2	
Conflicting Flow All	1632	708	0	0	708	0
Stage 1	708	-	-	-	-	-
Stage 2	924	-	-	-	-	-
Critical Hdwy	7.1	6.2	-	-	4.1	-
Critical Hdwy Stg 1	6.1	-	-	-	-	-
Critical Hdwy Stg 2	6.1	-	-	-	-	-
Follow-up Hdwy	3.5	3.3	-	-	2.2	-
Pot Cap-1 Maneuver	82	438	-	-	900	-
Stage 1	429	-	-	-	-	-
Stage 2	326	-	-	-	-	-
Platoon blocked, %			-	-		
Mov Cap-1 Maneuver	81	437	-	-	900	-
Mov Cap-2 Maneuver	81	-	-	-	-	-
Stage 1	429	-	-	-	-	-
Stage 2	319	-	-	-	-	-

Approach	WB		NB		SB
HCM Control Delay, s	13.3		0		0.2
HCM LOS	B				

Minor Lane/Major Mvmt	NBT	NBRWBLn1	SBL	SBT
Capacity (veh/h)	-	- 437	900	-
HCM Lane V/C Ratio	-	- 0.012	0.021	-
HCM Control Delay (s)	-	- 13.3	9.1	-
HCM Lane LOS	-	- B	A	-
HCM 95th %tile Q(veh)	-	- 0	0.1	-

Intersection

Int Delay, s/veh 6.3

Movement	WBL	WBR	NBT	NBR	SBL	SBT
Lane Configurations	Y		P			A
Traffic Vol, veh/h	4	6	1	6	19	0
Future Vol, veh/h	4	6	1	6	19	0
Conflicting Peds, #/hr	1	0	0	5	5	0
Sign Control	Stop	Stop	Free	Free	Free	Free
RT Channelized	-	None	-	None	-	None
Storage Length	0	-	-	-	-	-
Veh in Median Storage, #	0	-	0	-	-	0
Grade, %	0	-	0	-	-	0
Peak Hour Factor	75	75	75	75	75	75
Heavy Vehicles, %	0	17	0	0	0	0
Mvmt Flow	5	8	1	8	25	0

Major/Minor	Minor1		Major1		Major2	
Conflicting Flow All	62	10	0	0	14	0
Stage 1	10	-	-	-	-	-
Stage 2	52	-	-	-	-	-
Critical Hdwy	6.4	6.37	-	-	4.1	-
Critical Hdwy Stg 1	5.4	-	-	-	-	-
Critical Hdwy Stg 2	5.4	-	-	-	-	-
Follow-up Hdwy	3.5	3.453	-	-	2.2	-
Pot Cap-1 Maneuver	949	1029	-	-	1617	-
Stage 1	1018	-	-	-	-	-
Stage 2	976	-	-	-	-	-
Platoon blocked, %			-	-		-
Mov Cap-1 Maneuver	929	1024	-	-	1617	-
Mov Cap-2 Maneuver	929	-	-	-	-	-
Stage 1	1013	-	-	-	-	-
Stage 2	960	-	-	-	-	-

Approach	WB		NB		SB
HCM Control Delay, s	8.7		0		7.3
HCM LOS	A				

Minor Lane/Major Mvmt	NBT	NBRWBLn1	SBL	SBT
Capacity (veh/h)	-	- 984	1617	-
HCM Lane V/C Ratio	-	- 0.014	0.016	-
HCM Control Delay (s)	-	- 8.7	7.3	0
HCM Lane LOS	-	- A	A	A
HCM 95th %tile Q(veh)	-	- 0	0	-

Intersection

Int Delay, s/veh 2

Movement	EBT	EBR	WBL	WBT	NBL	NBR
Lane Configurations	↔		↔		↔	
Traffic Vol, veh/h	8	16	1	4	7	0
Future Vol, veh/h	8	16	1	4	7	0
Conflicting Peds, #/hr	0	3	3	0	1	0
Sign Control	Free	Free	Free	Free	Stop	Stop
RT Channelized	-	None	-	None	-	None
Storage Length	-	-	-	-	0	-
Veh in Median Storage, #	0	-	-	0	0	-
Grade, %	0	-	-	0	0	-
Peak Hour Factor	69	69	69	69	69	69
Heavy Vehicles, %	0	0	0	0	29	0
Mvmt Flow	12	23	1	6	10	0

Major/Minor	Major1	Major2	Minor1
Conflicting Flow All	0	0	36
Stage 1	-	-	26
Stage 2	-	-	10
Critical Hdwy	-	4.1	6.69
Critical Hdwy Stg 1	-	-	5.69
Critical Hdwy Stg 2	-	-	5.69
Follow-up Hdwy	-	2.2	3.761
Pot Cap-1 Maneuver	-	1585	912
Stage 1	-	-	931
Stage 2	-	-	947
Platoon blocked, %	-	-	-
Mov Cap-1 Maneuver	-	1585	908
Mov Cap-2 Maneuver	-	-	908
Stage 1	-	-	928
Stage 2	-	-	945

Approach	EB	WB	NB
HCM Control Delay, s	0	1.5	9
HCM LOS			A

Minor Lane/Major Mvmt	NBLn1	EBT	EBR	WBL	WBT
Capacity (veh/h)	908	-	-	1585	-
HCM Lane V/C Ratio	0.011	-	-	0.001	-
HCM Control Delay (s)	9	-	-	7.3	0
HCM Lane LOS	A	-	-	A	A
HCM 95th %tile Q(veh)	0	-	-	0	-

Intersection

Int Delay, s/veh 1

Movement	EBL	EBT	EBR	WBL	WBT	WBR	NBL	NBT	NBR	SBL	SBT	SBR
Lane Configurations		↔			↔		↑	↑		↑	↑	
Traffic Vol, veh/h	7	0	7	7	0	17	10	655	7	28	812	5
Future Vol, veh/h	7	0	7	7	0	17	10	655	7	28	812	5
Conflicting Peds, #/hr	0	0	0	0	0	0	0	0	2	2	0	0
Sign Control	Stop	Stop	Stop	Stop	Stop	Stop	Free	Free	Free	Free	Free	Free
RT Channelized	-	-	None	-	-	None	-	-	None	-	-	None
Storage Length	-	-	-	-	-	-	125	-	-	125	-	-
Veh in Median Storage, #	-	0	-	-	0	-	-	0	-	-	0	-
Grade, %	-	0	-	-	0	-	-	0	-	-	0	-
Peak Hour Factor	96	96	96	96	96	96	96	96	96	96	96	96
Heavy Vehicles, %	0	0	0	0	0	0	0	2	14	7	2	0
Mvmt Flow	7	0	7	7	0	18	10	682	7	29	846	5

Major/Minor	Minor2			Minor1			Major1			Major2		
Conflicting Flow All	1623	1619	848	1619	1618	688	851	0	0	692	0	0
Stage 1	907	907	-	709	709	-	-	-	-	-	-	-
Stage 2	716	712	-	910	909	-	-	-	-	-	-	-
Critical Hdwy	7.1	6.5	6.2	7.1	6.5	6.2	4.1	-	-	4.17	-	-
Critical Hdwy Stg 1	6.1	5.5	-	6.1	5.5	-	-	-	-	-	-	-
Critical Hdwy Stg 2	6.1	5.5	-	6.1	5.5	-	-	-	-	-	-	-
Follow-up Hdwy	3.5	4	3.3	3.5	4	3.3	2.2	-	-	2.263	-	-
Pot Cap-1 Maneuver	83	104	364	84	104	450	796	-	-	880	-	-
Stage 1	333	357	-	428	440	-	-	-	-	-	-	-
Stage 2	424	439	-	332	357	-	-	-	-	-	-	-
Platoon blocked, %												
Mov Cap-1 Maneuver	77	99	364	79	99	449	796	-	-	880	-	-
Mov Cap-2 Maneuver	77	99	-	79	99	-	-	-	-	-	-	-
Stage 1	329	345	-	422	434	-	-	-	-	-	-	-
Stage 2	402	433	-	315	345	-	-	-	-	-	-	-

Approach	EB	WB	NB	SB
HCM Control Delay, s	37	26.8	0.1	0.3
HCM LOS	E	D		

Minor Lane/Major Mvmt	NBL	NBT	NBR	EBLn1	WBLn1	SBL	SBT	SBR
Capacity (veh/h)	796	-	-	127	190	880	-	-
HCM Lane V/C Ratio	0.013	-	-	0.115	0.132	0.033	-	-
HCM Control Delay (s)	9.6	-	-	37	26.8	9.2	-	-
HCM Lane LOS	A	-	-	E	D	A	-	-
HCM 95th %tile Q(veh)	0	-	-	0.4	0.4	0.1	-	-

Intersection

Int Delay, s/veh 2.5

Movement	EBL	EBT	EBR	WBL	WBT	WBR	NBL	NBT	NBR	SBL	SBT	SBR
Lane Configurations		↔			↔		↔	↔		↔	↔	
Traffic Vol, veh/h	3	0	3	32	0	13	5	660	42	17	806	10
Future Vol, veh/h	3	0	3	32	0	13	5	660	42	17	806	10
Conflicting Peds, #/hr	1	0	0	0	0	1	1	0	0	0	0	1
Sign Control	Stop	Stop	Stop	Stop	Stop	Stop	Free	Free	Free	Free	Free	Free
RT Channelized	-	-	None	-	-	None	-	-	None	-	-	None
Storage Length	-	-	-	-	-	-	80	-	-	125	-	-
Veh in Median Storage, #	-	0	-	-	0	-	-	0	-	-	0	-
Grade, %	-	0	-	-	0	-	-	0	-	-	0	-
Peak Hour Factor	91	91	91	91	91	91	91	91	91	91	91	91
Heavy Vehicles, %	2	2	2	2	2	2	2	2	2	2	2	2
Mvmt Flow	3	0	3	35	0	14	5	725	46	19	886	11

Major/Minor	Minor2			Minor1			Major1			Major2		
Conflicting Flow All	1697	1712	892	1689	1694	749	898	0	0	771	0	0
Stage 1	930	930	-	759	759	-	-	-	-	-	-	-
Stage 2	767	782	-	930	935	-	-	-	-	-	-	-
Critical Hdwy	7.12	6.52	6.22	7.12	6.52	6.22	4.12	-	-	4.12	-	-
Critical Hdwy Stg 1	6.12	5.52	-	6.12	5.52	-	-	-	-	-	-	-
Critical Hdwy Stg 2	6.12	5.52	-	6.12	5.52	-	-	-	-	-	-	-
Follow-up Hdwy	3.518	4.018	3.318	3.518	4.018	3.318	2.218	-	-	2.218	-	-
Pot Cap-1 Maneuver	73	90	341	74	93	412	756	-	-	844	-	-
Stage 1	321	346	-	399	415	-	-	-	-	-	-	-
Stage 2	395	405	-	321	344	-	-	-	-	-	-	-
Platoon blocked, %												
Mov Cap-1 Maneuver	69	87	341	72	90	412	756	-	-	843	-	-
Mov Cap-2 Maneuver	69	87	-	72	90	-	-	-	-	-	-	-
Stage 1	319	338	-	396	412	-	-	-	-	-	-	-
Stage 2	378	402	-	311	336	-	-	-	-	-	-	-

Approach	EB	WB	NB	SB
HCM Control Delay, s	38.2	78.2	0.1	0.2
HCM LOS	E	F		

Minor Lane/Major Mvmt	NBL	NBT	NBR	EBLn1	WBLn1	SBL	SBT	SBR
Capacity (veh/h)	756	-	-	115	95	843	-	-
HCM Lane V/C Ratio	0.007	-	-	0.057	0.521	0.022	-	-
HCM Control Delay (s)	9.8	-	-	38.2	78.2	9.4	-	-
HCM Lane LOS	A	-	-	E	F	A	-	-
HCM 95th %tile Q(veh)	0	-	-	0.2	2.3	0.1	-	-

Intersection

Int Delay, s/veh 3.9

Movement	EBL	EBT	EBR	WBL	WBT	WBR	NBL	NBT	NBR	SBL	SBT	SBR
Lane Configurations		↕			↕			↕			↕	
Traffic Vol, veh/h	13	35	2	0	34	4	9	7	6	3	8	12
Future Vol, veh/h	13	35	2	0	34	4	9	7	6	3	8	12
Conflicting Peds, #/hr	0	0	1	1	0	0	0	0	0	0	0	0
Sign Control	Free	Free	Free	Free	Free	Free	Stop	Stop	Stop	Stop	Stop	Stop
RT Channelized	-	-	None	-	-	None	-	-	None	-	-	None
Storage Length	-	-	-	-	-	-	-	-	-	-	-	-
Veh in Median Storage, #	-	0	-	-	0	-	-	0	-	-	0	-
Grade, %	-	0	-	-	0	-	-	0	-	-	0	-
Peak Hour Factor	79	79	79	79	79	79	79	79	79	79	79	79
Heavy Vehicles, %	0	3	0	0	0	0	0	0	0	33	0	0
Mvmt Flow	16	44	3	0	43	5	11	9	8	4	10	15

Major/Minor	Major1			Major2			Minor1			Minor2		
Conflicting Flow All	48	0	0	48	0	0	137	127	47	133	127	46
Stage 1	-	-	-	-	-	-	79	79	-	46	46	-
Stage 2	-	-	-	-	-	-	58	48	-	87	81	-
Critical Hdwy	4.1	-	-	4.1	-	-	7.1	6.5	6.2	7.43	6.5	6.2
Critical Hdwy Stg 1	-	-	-	-	-	-	6.1	5.5	-	6.43	5.5	-
Critical Hdwy Stg 2	-	-	-	-	-	-	6.1	5.5	-	6.43	5.5	-
Follow-up Hdwy	2.2	-	-	2.2	-	-	3.5	4	3.3	3.797	4	3.3
Pot Cap-1 Maneuver	1572	-	-	1572	-	-	838	767	1028	772	767	1029
Stage 1	-	-	-	-	-	-	935	833	-	895	861	-
Stage 2	-	-	-	-	-	-	959	859	-	849	832	-
Platoon blocked, %		-	-		-	-		-	-		-	-
Mov Cap-1 Maneuver	1572	-	-	1572	-	-	810	759	1027	754	759	1029
Mov Cap-2 Maneuver	-	-	-	-	-	-	810	759	-	754	759	-
Stage 1	-	-	-	-	-	-	925	824	-	886	861	-
Stage 2	-	-	-	-	-	-	934	859	-	825	823	-

Approach	EB	WB	NB	SB
HCM Control Delay, s	1.9	0	9.4	9.2
HCM LOS			A	A

Minor Lane/Major Mvmt	NBLn1	EBL	EBT	EBR	WBL	WBT	WBR	SBLn1
Capacity (veh/h)	840	1572	-	-	1572	-	-	879
HCM Lane V/C Ratio	0.033	0.01	-	-	-	-	-	0.033
HCM Control Delay (s)	9.4	7.3	0	-	0	-	-	9.2
HCM Lane LOS	A	A	A	-	A	-	-	A
HCM 95th %tile Q(veh)	0.1	0	-	-	0	-	-	0.1

Intersection

Int Delay, s/veh 7.5

Movement	EBL	EBT	EBR	WBL	WBT	WBR	NBL	NBT	NBR	SBL	SBT	SBR
Lane Configurations		↕			↕			↕			↕	
Traffic Vol, veh/h	0	39	3	9	33	2	4	6	5	15	12	2
Future Vol, veh/h	0	39	3	9	33	2	4	6	5	15	12	2
Conflicting Peds, #/hr	3	0	0	0	0	3	3	0	2	2	0	3
Sign Control	Stop	Stop	Stop	Stop	Stop	Stop	Free	Free	Free	Free	Free	Free
RT Channelized	-	-	None	-	-	None	-	-	None	-	-	None
Storage Length	-	-	-	-	-	-	-	-	-	-	-	-
Veh in Median Storage, #	-	0	-	-	0	-	-	0	-	-	0	-
Grade, %	-	0	-	-	0	-	-	0	-	-	0	-
Peak Hour Factor	86	86	86	86	86	86	86	86	86	86	86	86
Heavy Vehicles, %	0	5	0	22	0	0	0	0	0	0	8	0
Mvmt Flow	0	45	3	10	38	2	5	7	6	17	14	2

Major/Minor	Minor2			Minor1			Major1			Major2		
Conflicting Flow All	96	77	18	95	75	15	19	0	0	15	0	0
Stage 1	53	53	-	21	21	-	-	-	-	-	-	-
Stage 2	43	24	-	74	54	-	-	-	-	-	-	-
Critical Hdwy	7.1	6.55	6.2	7.32	6.5	6.2	4.1	-	-	4.1	-	-
Critical Hdwy Stg 1	6.1	5.55	-	6.32	5.5	-	-	-	-	-	-	-
Critical Hdwy Stg 2	6.1	5.55	-	6.32	5.5	-	-	-	-	-	-	-
Follow-up Hdwy	3.5	4.045	3.3	3.698	4	3.3	2.2	-	-	2.2	-	-
Pot Cap-1 Maneuver	891	808	1066	842	819	1070	1611	-	-	1616	-	-
Stage 1	965	845	-	948	882	-	-	-	-	-	-	-
Stage 2	976	869	-	888	854	-	-	-	-	-	-	-
Platoon blocked, %												
Mov Cap-1 Maneuver	843	793	1063	793	804	1065	1611	-	-	1611	-	-
Mov Cap-2 Maneuver	843	793	-	793	804	-	-	-	-	-	-	-
Stage 1	959	833	-	943	878	-	-	-	-	-	-	-
Stage 2	926	865	-	828	842	-	-	-	-	-	-	-

Approach	EB	WB	NB	SB
HCM Control Delay, s	9.7	9.7	1.9	3.8
HCM LOS	A	A		

Minor Lane/Major Mvmt	NBL	NBT	NBR	EBLn1	WBLn1	SBL	SBT	SBR
Capacity (veh/h)	1611	-	-	808	811	1611	-	-
HCM Lane V/C Ratio	0.003	-	-	0.06	0.063	0.011	-	-
HCM Control Delay (s)	7.2	0	-	9.7	9.7	7.3	0	-
HCM Lane LOS	A	A	-	A	A	A	A	-
HCM 95th %tile Q(veh)	0	-	-	0.2	0.2	0	-	-

Intersection	
Intersection Delay, s/veh	7.3
Intersection LOS	A

Movement	EBU	EBL	EBT	EBR	WBU	WBL	WBT	WBR	NBU	NBL	NBT	NBR
Lane Configurations			↕				↕				↕	
Traffic Vol, veh/h	0	2	53	6	0	1	32	0	0	5	2	3
Future Vol, veh/h	0	2	53	6	0	1	32	0	0	5	2	3
Peak Hour Factor	0.92	0.75	0.75	0.75	0.92	0.75	0.75	0.75	0.92	0.75	0.75	0.75
Heavy Vehicles, %	2	0	4	0	2	0	0	0	2	40	0	0
Mvmt Flow	0	3	71	8	0	1	43	0	0	7	3	4
Number of Lanes	0	0	1	0	0	0	1	0	0	0	1	0

Approach	EB	WB	NB
Opposing Approach	WB	EB	SB
Opposing Lanes	1	1	1
Conflicting Approach Left	SB	NB	EB
Conflicting Lanes Left	1	1	1
Conflicting Approach Right	NB	SB	WB
Conflicting Lanes Right	1	1	1
HCM Control Delay	7.3	7.2	7.9
HCM LOS	A	A	A

Lane	NBLn1	EBLn1	WBLn1	SBLn1
Vol Left, %	50%	3%	3%	0%
Vol Thru, %	20%	87%	97%	0%
Vol Right, %	30%	10%	0%	100%
Sign Control	Stop	Stop	Stop	Stop
Traffic Vol by Lane	10	61	33	4
LT Vol	5	2	1	0
Through Vol	2	53	32	0
RT Vol	3	6	0	4
Lane Flow Rate	13	81	44	5
Geometry Grp	1	1	1	1
Degree of Util (X)	0.017	0.088	0.049	0.005
Departure Headway (Hd)	4.721	3.914	4	3.525
Convergence, Y/N	Yes	Yes	Yes	Yes
Cap	755	917	895	1006
Service Time	2.771	1.932	2.023	1.579
HCM Lane V/C Ratio	0.017	0.088	0.049	0.005
HCM Control Delay	7.9	7.3	7.2	6.6
HCM Lane LOS	A	A	A	A
HCM 95th-tile Q	0.1	0.3	0.2	0

Intersection

Intersection Delay, s/veh
 Intersection LOS

Movement	SBU	SBL	SBT	SBR
Lane Configurations			↔	
Traffic Vol, veh/h	0	0	0	4
Future Vol, veh/h	0	0	0	4
Peak Hour Factor	0.92	0.75	0.75	0.75
Heavy Vehicles, %	2	0	0	0
Mvmt Flow	0	0	0	5
Number of Lanes	0	0	1	0

Approach SB

Opposing Approach	NB
Opposing Lanes	1
Conflicting Approach Left	WB
Conflicting Lanes Left	1
Conflicting Approach Right	EB
Conflicting Lanes Right	1
HCM Control Delay	6.6
HCM LOS	A

Intersection

Int Delay, s/veh 0.1

Movement	EBL	EBR	NBL	NBT	SBT	SBR
Lane Configurations	Y			Y	Y	
Traffic Vol, veh/h	1	2	8	691	835	1
Future Vol, veh/h	1	2	8	691	835	1
Conflicting Peds, #/hr	0	0	0	0	0	0
Sign Control	Stop	Stop	Free	Free	Free	Free
RT Channelized	-	None	-	None	-	None
Storage Length	0	-	-	-	-	-
Veh in Median Storage, #	0	-	-	0	0	-
Grade, %	0	-	-	0	0	-
Peak Hour Factor	91	91	91	91	91	92
Heavy Vehicles, %	2	2	2	2	2	2
Mvmt Flow	1	2	9	759	918	1

Major/Minor	Minor2		Major1		Major2	
Conflicting Flow All	1695	918	919	0	-	0
Stage 1	918	-	-	-	-	-
Stage 2	777	-	-	-	-	-
Critical Hdwy	6.42	6.22	4.12	-	-	-
Critical Hdwy Stg 1	5.42	-	-	-	-	-
Critical Hdwy Stg 2	5.42	-	-	-	-	-
Follow-up Hdwy	3.518	3.318	2.218	-	-	-
Pot Cap-1 Maneuver	102	329	743	-	-	-
Stage 1	389	-	-	-	-	-
Stage 2	453	-	-	-	-	-
Platoon blocked, %				-	-	-
Mov Cap-1 Maneuver	100	329	743	-	-	-
Mov Cap-2 Maneuver	100	-	-	-	-	-
Stage 1	389	-	-	-	-	-
Stage 2	443	-	-	-	-	-

Approach	EB	NB	SB
HCM Control Delay, s	24.6	0.1	0
HCM LOS	C		

Minor Lane/Major Mvmt	NBL	NBT	EBLn1	SBT	SBR
Capacity (veh/h)	743	-	187	-	-
HCM Lane V/C Ratio	0.012	-	0.018	-	-
HCM Control Delay (s)	9.9	0	24.6	-	-
HCM Lane LOS	A	A	C	-	-
HCM 95th %tile Q(veh)	0	-	0.1	-	-

Intersection

Int Delay, s/veh 0.2

Movement	WBL	WBR	NBT	NBR	SBL	SBT
Lane Configurations	↘		↑	↗		↖
Traffic Vol, veh/h	7	3	741	9	4	957
Future Vol, veh/h	7	3	741	9	4	957
Conflicting Peds, #/hr	0	0	0	1	1	0
Sign Control	Stop	Stop	Free	Free	Free	Free
RT Channelized	-	None	-	None	-	None
Storage Length	0	-	-	125	-	-
Veh in Median Storage, #	0	-	0	-	-	0
Grade, %	0	-	0	-	-	0
Peak Hour Factor	96	96	96	96	96	96
Heavy Vehicles, %	0	0	2	0	0	1
Mvmt Flow	7	3	772	9	4	997

Major/Minor	Minor1		Major1		Major2	
Conflicting Flow All	1778	773	0	0	773	0
Stage 1	773	-	-	-	-	-
Stage 2	1005	-	-	-	-	-
Critical Hdwy	6.4	6.2	-	-	4.1	-
Critical Hdwy Stg 1	5.4	-	-	-	-	-
Critical Hdwy Stg 2	5.4	-	-	-	-	-
Follow-up Hdwy	3.5	3.3	-	-	2.2	-
Pot Cap-1 Maneuver	92	402	-	-	851	-
Stage 1	459	-	-	-	-	-
Stage 2	357	-	-	-	-	-
Platoon blocked, %			-	-		
Mov Cap-1 Maneuver	91	402	-	-	851	-
Mov Cap-2 Maneuver	91	-	-	-	-	-
Stage 1	459	-	-	-	-	-
Stage 2	353	-	-	-	-	-

Approach	WB		NB		SB
HCM Control Delay, s	38.1		0		0
HCM LOS	E				

Minor Lane/Major Mvmt	NBT	NBRWBLn1	SBL	SBT
Capacity (veh/h)	-	- 119	851	-
HCM Lane V/C Ratio	-	- 0.088	0.005	-
HCM Control Delay (s)	-	- 38.1	9.3	0
HCM Lane LOS	-	- E	A	A
HCM 95th %tile Q(veh)	-	- 0.3	0	-

Intersection

Int Delay, s/veh 0

Movement	EBL	EBT	EBR	WBL	WBT	WBR	NBL	NBT	NBR	SBL	SBT	SBR
Lane Configurations		↕			↕		↕	↕		↕	↕	
Traffic Vol, veh/h	0	0	0	1	0	1	2	740	0	1	966	4
Future Vol, veh/h	0	0	0	1	0	1	2	740	0	1	966	4
Conflicting Peds, #/hr	0	0	1	1	0	0	0	0	3	3	0	0
Sign Control	Stop	Stop	Stop	Stop	Stop	Stop	Free	Free	Free	Free	Free	Free
RT Channelized	-	-	None	-	-	None	-	-	None	-	-	None
Storage Length	-	-	-	-	-	-	65	-	-	50	-	-
Veh in Median Storage, #	-	0	-	-	0	-	-	0	-	-	0	-
Grade, %	-	0	-	-	0	-	-	0	-	-	0	-
Peak Hour Factor	96	96	96	96	96	96	96	96	96	96	96	96
Heavy Vehicles, %	0	0	0	0	0	0	0	3	0	0	2	0
Mvmt Flow	0	0	0	1	0	1	2	771	0	1	1006	4

Major/Minor	Minor2			Minor1			Major1			Major2		
Conflicting Flow All	1786	1788	1009	1789	1791	774	1010	0	0	774	0	0
Stage 1	1010	1010	-	778	778	-	-	-	-	-	-	-
Stage 2	776	778	-	1011	1013	-	-	-	-	-	-	-
Critical Hdwy	7.1	6.5	6.2	7.1	6.5	6.2	4.1	-	-	4.1	-	-
Critical Hdwy Stg 1	6.1	5.5	-	6.1	5.5	-	-	-	-	-	-	-
Critical Hdwy Stg 2	6.1	5.5	-	6.1	5.5	-	-	-	-	-	-	-
Follow-up Hdwy	3.5	4	3.3	3.5	4	3.3	2.2	-	-	2.2	-	-
Pot Cap-1 Maneuver	64	82	294	64	82	402	694	-	-	851	-	-
Stage 1	292	320	-	392	410	-	-	-	-	-	-	-
Stage 2	393	410	-	291	319	-	-	-	-	-	-	-
Platoon blocked, %												
Mov Cap-1 Maneuver	64	81	294	64	81	401	693	-	-	851	-	-
Mov Cap-2 Maneuver	64	81	-	64	81	-	-	-	-	-	-	-
Stage 1	291	320	-	390	408	-	-	-	-	-	-	-
Stage 2	391	408	-	290	319	-	-	-	-	-	-	-

Approach	EB	WB	NB	SB
HCM Control Delay, s	0	38.4	0	0
HCM LOS	A	E		

Minor Lane/Major Mvmt	NBL	NBT	NBR	EBLn1WBLn1	SBL	SBT	SBR
Capacity (veh/h)	693	-	-	- 110	851	-	-
HCM Lane V/C Ratio	0.003	-	-	- 0.019	0.001	-	-
HCM Control Delay (s)	10.2	-	-	0 38.4	9.2	-	-
HCM Lane LOS	B	-	-	A E	A	-	-
HCM 95th %tile Q(veh)	0	-	-	- 0.1	0	-	-

Intersection

Int Delay, s/veh 0.2

Movement	WBL	WBR	NBT	NBR	SBL	SBT
Lane Configurations	Y		P		T	T
Traffic Vol, veh/h	0	11	734	0	8	958
Future Vol, veh/h	0	11	734	0	8	958
Conflicting Peds, #/hr	0	0	0	1	1	0
Sign Control	Stop	Stop	Free	Free	Free	Free
RT Channelized	-	None	-	None	-	None
Storage Length	0	-	-	-	65	-
Veh in Median Storage, #	0	-	0	-	-	0
Grade, %	0	-	0	-	-	0
Peak Hour Factor	93	93	93	93	93	93
Heavy Vehicles, %	0	9	2	0	0	1
Mvmt Flow	0	12	789	0	9	1030

Major/Minor	Minor1		Major1		Major2	
Conflicting Flow All	1837	790	0	0	790	0
Stage 1	790	-	-	-	-	-
Stage 2	1047	-	-	-	-	-
Critical Hdwy	6.4	6.29	-	-	4.1	-
Critical Hdwy Stg 1	5.4	-	-	-	-	-
Critical Hdwy Stg 2	5.4	-	-	-	-	-
Follow-up Hdwy	3.5	3.381	-	-	2.2	-
Pot Cap-1 Maneuver	84	379	-	-	839	-
Stage 1	451	-	-	-	-	-
Stage 2	341	-	-	-	-	-
Platoon blocked, %			-	-		
Mov Cap-1 Maneuver	83	379	-	-	839	-
Mov Cap-2 Maneuver	83	-	-	-	-	-
Stage 1	451	-	-	-	-	-
Stage 2	337	-	-	-	-	-

Approach	WB		NB		SB
HCM Control Delay, s	14.8		0		0.1
HCM LOS	B				

Minor Lane/Major Mvmt	NBT	NBRWBLn1	SBL	SBT
Capacity (veh/h)	-	- 379	839	-
HCM Lane V/C Ratio	-	- 0.031	0.01	-
HCM Control Delay (s)	-	- 14.8	9.3	-
HCM Lane LOS	-	- B	A	-
HCM 95th %tile Q(veh)	-	- 0.1	0	-

Intersection

Int Delay, s/veh 6.7

Movement	WBL	WBR	NBT	NBR	SBL	SBT
Lane Configurations	Y		P			A
Traffic Vol, veh/h	3	13	1	2	6	2
Future Vol, veh/h	3	13	1	2	6	2
Conflicting Peds, #/hr	2	0	0	0	0	0
Sign Control	Stop	Stop	Free	Free	Free	Free
RT Channelized	-	None	-	None	-	None
Storage Length	0	-	-	-	-	-
Veh in Median Storage, #	0	-	0	-	-	0
Grade, %	0	-	0	-	-	0
Peak Hour Factor	75	75	75	75	75	75
Heavy Vehicles, %	33	8	0	0	0	0
Mvmt Flow	4	17	1	3	8	3

Major/Minor	Minor1		Major1		Major2	
Conflicting Flow All	24	3	0	0	4	0
Stage 1	3	-	-	-	-	-
Stage 2	21	-	-	-	-	-
Critical Hdwy	6.73	6.28	-	-	4.1	-
Critical Hdwy Stg 1	5.73	-	-	-	-	-
Critical Hdwy Stg 2	5.73	-	-	-	-	-
Follow-up Hdwy	3.797	3.372	-	-	2.2	-
Pot Cap-1 Maneuver	918	1064	-	-	1631	-
Stage 1	945	-	-	-	-	-
Stage 2	927	-	-	-	-	-
Platoon blocked, %			-	-		-
Mov Cap-1 Maneuver	912	1064	-	-	1631	-
Mov Cap-2 Maneuver	912	-	-	-	-	-
Stage 1	945	-	-	-	-	-
Stage 2	921	-	-	-	-	-

Approach	WB		NB		SB
HCM Control Delay, s	8.6		0		5.4
HCM LOS	A				

Minor Lane/Major Mvmt	NBT	NBRWBLn1	SBL	SBT
Capacity (veh/h)	-	- 1032	1631	-
HCM Lane V/C Ratio	-	- 0.021	0.005	-
HCM Control Delay (s)	-	- 8.6	7.2	0
HCM Lane LOS	-	- A	A	A
HCM 95th %tile Q(veh)	-	- 0.1	0	-

Intersection

Int Delay, s/veh 5.9

Movement	EBT	EBR	WBL	WBT	NBL	NBR
Lane Configurations	↔		↔		↔	
Traffic Vol, veh/h	2	5	1	0	13	1
Future Vol, veh/h	2	5	1	0	13	1
Conflicting Peds, #/hr	0	1	1	0	0	0
Sign Control	Free	Free	Free	Free	Stop	Stop
RT Channelized	-	None	-	None	-	None
Storage Length	-	-	-	-	0	-
Veh in Median Storage, #	0	-	-	0	0	-
Grade, %	0	-	-	0	0	-
Peak Hour Factor	79	79	79	79	79	79
Heavy Vehicles, %	0	0	100	0	15	0
Mvmt Flow	3	6	1	0	16	1

Major/Minor	Major1	Major2	Minor1
Conflicting Flow All	0	0	10
Stage 1	-	-	7
Stage 2	-	-	3
Critical Hdwy	-	5.1	6.55
Critical Hdwy Stg 1	-	-	5.55
Critical Hdwy Stg 2	-	-	5.55
Follow-up Hdwy	-	3.1	3.635
Pot Cap-1 Maneuver	-	1150	977
Stage 1	-	-	983
Stage 2	-	-	987
Platoon blocked, %	-	-	-
Mov Cap-1 Maneuver	-	1150	975
Mov Cap-2 Maneuver	-	-	975
Stage 1	-	-	982
Stage 2	-	-	986

Approach	EB	WB	NB
HCM Control Delay, s	0	8.1	8.7
HCM LOS			A

Minor Lane/Major Mvmt	NBLn1	EBT	EBR	WBL	WBT
Capacity (veh/h)	982	-	-	1150	-
HCM Lane V/C Ratio	0.018	-	-	0.001	-
HCM Control Delay (s)	8.7	-	-	8.1	0
HCM Lane LOS	A	-	-	A	A
HCM 95th %tile Q(veh)	0.1	-	-	0	-

Intersection												
Int Delay, s/veh	0.8											
Movement	EBL	EBT	EBR	WBL	WBT	WBR	NBL	NBT	NBR	SBL	SBT	SBR
Lane Configurations		↔			↔		↑	↑		↑	↑	
Traffic Vol, veh/h	0	0	6	6	1	25	9	713	2	22	928	5
Future Vol, veh/h	0	0	6	6	1	25	9	713	2	22	928	5
Conflicting Peds, #/hr	0	0	0	0	0	0	0	0	1	1	0	0
Sign Control	Stop	Stop	Stop	Stop	Stop	Stop	Free	Free	Free	Free	Free	Free
RT Channelized	-	-	None	-	-	None	-	-	None	-	-	None
Storage Length	-	-	-	-	-	-	125	-	-	125	-	-
Veh in Median Storage, #	-	0	-	-	0	-	-	0	-	-	0	-
Grade, %	-	0	-	-	0	-	-	0	-	-	0	-
Peak Hour Factor	95	95	95	95	95	95	95	95	95	95	95	95
Heavy Vehicles, %	0	0	0	17	0	4	0	3	0	5	1	0
Mvmt Flow	0	0	6	6	1	26	9	751	2	23	977	5
Major/Minor	Minor2			Minor1			Major1			Major2		
Conflicting Flow All	1810	1799	979	1801	1800	753	982	0	0	754	0	0
Stage 1	1026	1026	-	772	772	-	-	-	-	-	-	-
Stage 2	784	773	-	1029	1028	-	-	-	-	-	-	-
Critical Hdwy	7.1	6.5	6.2	7.27	6.5	6.24	4.1	-	-	4.15	-	-
Critical Hdwy Stg 1	6.1	5.5	-	6.27	5.5	-	-	-	-	-	-	-
Critical Hdwy Stg 2	6.1	5.5	-	6.27	5.5	-	-	-	-	-	-	-
Follow-up Hdwy	3.5	4	3.3	3.653	4	3.336	2.2	-	-	2.245	-	-
Pot Cap-1 Maneuver	62	81	306	57	81	406	711	-	-	843	-	-
Stage 1	286	315	-	370	412	-	-	-	-	-	-	-
Stage 2	389	412	-	265	314	-	-	-	-	-	-	-
Platoon blocked, %												
Mov Cap-1 Maneuver	56	78	306	54	78	406	711	-	-	843	-	-
Mov Cap-2 Maneuver	56	78	-	54	78	-	-	-	-	-	-	-
Stage 1	282	306	-	365	406	-	-	-	-	-	-	-
Stage 2	358	406	-	252	305	-	-	-	-	-	-	-
Approach	EB			WB			NB			SB		
HCM Control Delay, s	17			31			0.1			0.2		
HCM LOS	C			D								
Minor Lane/Major Mvmt	NBL	NBT	NBR	EBLn1	WBLn1	SBL	SBT	SBR				
Capacity (veh/h)	711	-	-	306	172	843	-	-				
HCM Lane V/C Ratio	0.013	-	-	0.021	0.196	0.027	-	-				
HCM Control Delay (s)	10.1	-	-	17	31	9.4	-	-				
HCM Lane LOS	B	-	-	C	D	A	-	-				
HCM 95th %tile Q(veh)	0	-	-	0.1	0.7	0.1	-	-				

Intersection

Int Delay, s/veh 3.3

Movement	EBL	EBT	EBR	WBL	WBT	WBR	NBL	NBT	NBR	SBL	SBT	SBR
Lane Configurations		↔			↔		↔	↔		↔	↔	
Traffic Vol, veh/h	6	3	21	23	3	23	28	697	36	7	928	7
Future Vol, veh/h	6	3	21	23	3	23	28	697	36	7	928	7
Conflicting Peds, #/hr	1	0	0	0	0	1	0	0	0	0	0	0
Sign Control	Stop	Stop	Stop	Stop	Stop	Stop	Free	Free	Free	Free	Free	Free
RT Channelized	-	-	None	-	-	None	-	-	None	-	-	None
Storage Length	-	-	-	-	-	-	80	-	-	125	-	-
Veh in Median Storage, #	-	0	-	-	0	-	-	0	-	-	0	-
Grade, %	-	0	-	-	0	-	-	0	-	-	0	-
Peak Hour Factor	95	95	95	95	95	95	95	95	95	95	95	95
Heavy Vehicles, %	2	2	2	2	2	2	2	2	2	2	2	2
Mvmt Flow	6	3	22	24	3	24	29	734	38	7	977	7

Major/Minor	Minor2			Minor1			Major1			Major2		
Conflicting Flow All	1821	1826	981	1820	1811	754	984	0	0	772	0	0
Stage 1	995	995	-	812	812	-	-	-	-	-	-	-
Stage 2	826	831	-	1008	999	-	-	-	-	-	-	-
Critical Hdwy	7.12	6.52	6.22	7.12	6.52	6.22	4.12	-	-	4.12	-	-
Critical Hdwy Stg 1	6.12	5.52	-	6.12	5.52	-	-	-	-	-	-	-
Critical Hdwy Stg 2	6.12	5.52	-	6.12	5.52	-	-	-	-	-	-	-
Follow-up Hdwy	3.518	4.018	3.318	3.518	4.018	3.318	2.218	-	-	2.218	-	-
Pot Cap-1 Maneuver	60	77	303	60	79	409	702	-	-	843	-	-
Stage 1	295	323	-	373	392	-	-	-	-	-	-	-
Stage 2	366	384	-	290	321	-	-	-	-	-	-	-
Platoon blocked, %												
Mov Cap-1 Maneuver	53	73	303	52	75	409	702	-	-	842	-	-
Mov Cap-2 Maneuver	53	73	-	52	75	-	-	-	-	-	-	-
Stage 1	283	320	-	358	376	-	-	-	-	-	-	-
Stage 2	327	368	-	264	318	-	-	-	-	-	-	-

Approach	EB	WB	NB	SB
HCM Control Delay, s	40	87.1	0.4	0.1
HCM LOS	E	F		

Minor Lane/Major Mvmt	NBL	NBT	NBR	EBLn1	WBLn1	SBL	SBT	SBR
Capacity (veh/h)	702	-	-	134	91	842	-	-
HCM Lane V/C Ratio	0.042	-	-	0.236	0.567	0.009	-	-
HCM Control Delay (s)	10.4	-	-	40	87.1	9.3	-	-
HCM Lane LOS	B	-	-	E	F	A	-	-
HCM 95th %tile Q(veh)	0.1	-	-	0.9	2.6	0	-	-

Intersection

Int Delay, s/veh 4.5

Movement	EBL	EBT	EBR	WBL	WBT	WBR	NBL	NBT	NBR	SBL	SBT	SBR
Lane Configurations		↕			↕			↕			↕	
Traffic Vol, veh/h	25	33	2	5	31	17	10	9	3	6	17	8
Future Vol, veh/h	25	33	2	5	31	17	10	9	3	6	17	8
Conflicting Peds, #/hr	1	0	0	0	0	1	0	0	2	2	0	0
Sign Control	Free	Free	Free	Free	Free	Free	Stop	Stop	Stop	Stop	Stop	Stop
RT Channelized	-	-	None	-	-	None	-	-	None	-	-	None
Storage Length	-	-	-	-	-	-	-	-	-	-	-	-
Veh in Median Storage, #	-	0	-	-	0	-	-	0	-	-	0	-
Grade, %	-	0	-	-	0	-	-	0	-	-	0	-
Peak Hour Factor	83	83	83	83	83	83	83	83	83	83	83	83
Heavy Vehicles, %	0	0	0	0	0	0	0	0	0	0	0	0
Mvmt Flow	30	40	2	6	37	20	12	11	4	7	20	10

Major/Minor	Major1	Major2	Minor1	Minor2								
Conflicting Flow All	59	0	0	42	0	0	176	172	43	171	163	49
Stage 1	-	-	-	-	-	-	101	101	-	61	61	-
Stage 2	-	-	-	-	-	-	75	71	-	110	102	-
Critical Hdwy	4.1	-	-	4.1	-	-	7.1	6.5	6.2	7.1	6.5	6.2
Critical Hdwy Stg 1	-	-	-	-	-	-	6.1	5.5	-	6.1	5.5	-
Critical Hdwy Stg 2	-	-	-	-	-	-	6.1	5.5	-	6.1	5.5	-
Follow-up Hdwy	2.2	-	-	2.2	-	-	3.5	4	3.3	3.5	4	3.3
Pot Cap-1 Maneuver	1558	-	-	1580	-	-	791	725	1033	797	733	1025
Stage 1	-	-	-	-	-	-	910	815	-	955	848	-
Stage 2	-	-	-	-	-	-	939	840	-	900	815	-
Platoon blocked, %	-	-	-	-	-	-	-	-	-	-	-	-
Mov Cap-1 Maneuver	1558	-	-	1577	-	-	752	707	1031	768	715	1024
Mov Cap-2 Maneuver	-	-	-	-	-	-	752	707	-	768	715	-
Stage 1	-	-	-	-	-	-	892	799	-	935	844	-
Stage 2	-	-	-	-	-	-	904	836	-	865	799	-

Approach	EB	WB	NB	SB
HCM Control Delay, s	3.1	0.7	9.9	9.8
HCM LOS			A	A

Minor Lane/Major Mvmt	NBLn1	EBL	EBT	EBR	WBL	WBT	WBR	SBLn1
Capacity (veh/h)	760	1558	-	-	1577	-	-	787
HCM Lane V/C Ratio	0.035	0.019	-	-	0.004	-	-	0.047
HCM Control Delay (s)	9.9	7.4	0	-	7.3	0	-	9.8
HCM Lane LOS	A	A	A	-	A	A	-	A
HCM 95th %tile Q(veh)	0.1	0.1	-	-	0	-	-	0.1

Intersection

Int Delay, s/veh 6.9

Movement	EBL	EBT	EBR	WBL	WBT	WBR	NBL	NBT	NBR	SBL	SBT	SBR
Lane Configurations		↕			↕			↕			↕	
Traffic Vol, veh/h	2	37	3	10	37	2	7	13	7	8	16	3
Future Vol, veh/h	2	37	3	10	37	2	7	13	7	8	16	3
Conflicting Peds, #/hr	4	0	0	0	0	4	1	0	1	1	0	1
Sign Control	Stop	Stop	Stop	Stop	Stop	Stop	Free	Free	Free	Free	Free	Free
RT Channelized	-	-	None	-	-	None	-	-	None	-	-	None
Storage Length	-	-	-	-	-	-	-	-	-	-	-	-
Veh in Median Storage, #	-	0	-	-	0	-	-	0	-	-	0	-
Grade, %	-	0	-	-	0	-	-	0	-	-	0	-
Peak Hour Factor	84	84	84	84	84	84	84	84	84	84	84	84
Heavy Vehicles, %	0	0	0	0	0	0	0	8	14	0	6	0
Mvmt Flow	2	44	4	12	44	2	8	15	8	10	19	4

Major/Minor	Minor2			Minor1			Major1			Major2		
Conflicting Flow All	105	82	22	101	80	25	24	0	0	25	0	0
Stage 1	41	41	-	37	37	-	-	-	-	-	-	-
Stage 2	64	41	-	64	43	-	-	-	-	-	-	-
Critical Hdwy	7.1	6.5	6.2	7.1	6.5	6.2	4.1	-	-	4.1	-	-
Critical Hdwy Stg 1	6.1	5.5	-	6.1	5.5	-	-	-	-	-	-	-
Critical Hdwy Stg 2	6.1	5.5	-	6.1	5.5	-	-	-	-	-	-	-
Follow-up Hdwy	3.5	4	3.3	3.5	4	3.3	2.2	-	-	2.2	-	-
Pot Cap-1 Maneuver	880	812	1061	885	814	1057	1604	-	-	1603	-	-
Stage 1	979	865	-	984	868	-	-	-	-	-	-	-
Stage 2	952	865	-	952	863	-	-	-	-	-	-	-
Platoon blocked, %												
Mov Cap-1 Maneuver	830	802	1060	837	804	1052	1604	-	-	1597	-	-
Mov Cap-2 Maneuver	830	802	-	837	804	-	-	-	-	-	-	-
Stage 1	973	859	-	978	863	-	-	-	-	-	-	-
Stage 2	893	860	-	895	857	-	-	-	-	-	-	-

Approach	EB	WB	NB	SB
HCM Control Delay, s	9.7	9.7	1.9	2.2
HCM LOS	A	A		

Minor Lane/Major Mvmt	NBL	NBT	NBR	EBLn1WBLn1	SBL	SBT	SBR
Capacity (veh/h)	1604	-	-	818	818	1597	-
HCM Lane V/C Ratio	0.005	-	-	0.061	0.071	0.006	-
HCM Control Delay (s)	7.3	0	-	9.7	9.7	7.3	0
HCM Lane LOS	A	A	-	A	A	A	A
HCM 95th %tile Q(veh)	0	-	-	0.2	0.2	0	-

Intersection	
Intersection Delay, s/veh	7.2
Intersection LOS	A

Movement	EBU	EBL	EBT	EBR	WBU	WBL	WBT	WBR	NBU	NBL	NBT	NBR
Lane Configurations			↕				↕				↕	
Traffic Vol, veh/h	0	4	45	3	0	2	40	0	0	4	1	4
Future Vol, veh/h	0	4	45	3	0	2	40	0	0	4	1	4
Peak Hour Factor	0.92	0.83	0.83	0.83	0.92	0.83	0.83	0.83	0.92	0.83	0.83	0.83
Heavy Vehicles, %	2	0	2	0	2	0	0	0	2	0	0	0
Mvmt Flow	0	5	54	4	0	2	48	0	0	5	1	5
Number of Lanes	0	0	1	0	0	0	1	0	0	0	1	0

Approach	EB	WB	NB
Opposing Approach	WB	EB	SB
Opposing Lanes	1	1	1
Conflicting Approach Left	SB	NB	EB
Conflicting Lanes Left	1	1	1
Conflicting Approach Right	NB	SB	WB
Conflicting Lanes Right	1	1	1
HCM Control Delay	7.3	7.2	7
HCM LOS	A	A	A

Lane	NBLn1	EBLn1	WBLn1	SBLn1
Vol Left, %	44%	8%	5%	0%
Vol Thru, %	11%	87%	95%	14%
Vol Right, %	44%	6%	0%	86%
Sign Control	Stop	Stop	Stop	Stop
Traffic Vol by Lane	9	52	42	7
LT Vol	4	4	2	0
Through Vol	1	45	40	1
RT Vol	4	3	0	6
Lane Flow Rate	11	63	51	8
Geometry Grp	1	1	1	1
Degree of Util (X)	0.012	0.069	0.056	0.008
Departure Headway (Hd)	3.924	3.952	3.99	3.59
Convergence, Y/N	Yes	Yes	Yes	Yes
Cap	907	908	899	990
Service Time	1.971	1.967	2.007	1.638
HCM Lane V/C Ratio	0.012	0.069	0.057	0.008
HCM Control Delay	7	7.3	7.2	6.7
HCM Lane LOS	A	A	A	A
HCM 95th-tile Q	0	0.2	0.2	0

Intersection

Intersection Delay, s/veh
 Intersection LOS

Movement	SBU	SBL	SBT	SBR
Lane Configurations			↕	
Traffic Vol, veh/h	0	0	1	6
Future Vol, veh/h	0	0	1	6
Peak Hour Factor	0.92	0.83	0.83	0.83
Heavy Vehicles, %	2	0	0	0
Mvmt Flow	0	0	1	7
Number of Lanes	0	0	1	0

Approach SB

Opposing Approach	NB
Opposing Lanes	1
Conflicting Approach Left	WB
Conflicting Lanes Left	1
Conflicting Approach Right	EB
Conflicting Lanes Right	1
HCM Control Delay	6.7
HCM LOS	A

Intersection

Int Delay, s/veh 0.2

Movement	EBL	EBR	NBL	NBT	SBT	SBR
Lane Configurations	Y			Y	Y	
Traffic Vol, veh/h	3	8	4	724	935	5
Future Vol, veh/h	3	8	4	724	935	5
Conflicting Peds, #/hr	0	0	1	0	0	1
Sign Control	Stop	Stop	Free	Free	Free	Free
RT Channelized	-	None	-	None	-	None
Storage Length	0	-	-	-	-	-
Veh in Median Storage, #	0	-	-	0	0	-
Grade, %	0	-	-	0	0	-
Peak Hour Factor	95	95	95	95	95	95
Heavy Vehicles, %	2	2	2	2	2	2
Mvmt Flow	3	8	4	762	984	5

Major/Minor	Minor2	Major1		Major2	
Conflicting Flow All	1759	988	990	0	0
Stage 1	988	-	-	-	-
Stage 2	771	-	-	-	-
Critical Hdwy	6.42	6.22	4.12	-	-
Critical Hdwy Stg 1	5.42	-	-	-	-
Critical Hdwy Stg 2	5.42	-	-	-	-
Follow-up Hdwy	3.518	3.318	2.218	-	-
Pot Cap-1 Maneuver	93	300	698	-	-
Stage 1	361	-	-	-	-
Stage 2	456	-	-	-	-
Platoon blocked, %				-	-
Mov Cap-1 Maneuver	92	300	698	-	-
Mov Cap-2 Maneuver	92	-	-	-	-
Stage 1	361	-	-	-	-
Stage 2	451	-	-	-	-

Approach	EB	NB	SB
HCM Control Delay, s	25.6	0.1	0
HCM LOS	D		

Minor Lane/Major Mvmt	NBL	NBT	EBLn1	SBT	SBR
Capacity (veh/h)	698	-	186	-	-
HCM Lane V/C Ratio	0.006	-	0.062	-	-
HCM Control Delay (s)	10.2	0	25.6	-	-
HCM Lane LOS	B	A	D	-	-
HCM 95th %tile Q(veh)	0	-	0.2	-	-

Appendix 5 Existing with Project Conditions Level-of-Service Worksheets

Intersection

Int Delay, s/veh 0.4

Movement	WBL	WBR	NBT	NBR	SBL	SBT
Lane Configurations	↕		↑	↗		↖
Traffic Vol, veh/h	14	7	694	15	1	571
Future Vol, veh/h	14	7	694	15	1	571
Conflicting Peds, #/hr	0	0	0	0	0	0
Sign Control	Stop	Stop	Free	Free	Free	Free
RT Channelized	-	None	-	None	-	None
Storage Length	0	-	-	125	-	-
Veh in Median Storage, #	0	-	0	-	-	0
Grade, %	0	-	0	-	-	0
Peak Hour Factor	92	92	92	92	92	92
Heavy Vehicles, %	0	0	6	0	0	4
Mvmt Flow	15	8	754	16	1	621

Major/Minor	Minor1		Major1		Major2	
Conflicting Flow All	1377	754	0	0	754	0
Stage 1	754	-	-	-	-	-
Stage 2	623	-	-	-	-	-
Critical Hdwy	6.4	6.2	-	-	4.1	-
Critical Hdwy Stg 1	5.4	-	-	-	-	-
Critical Hdwy Stg 2	5.4	-	-	-	-	-
Follow-up Hdwy	3.5	3.3	-	-	2.2	-
Pot Cap-1 Maneuver	161	412	-	-	865	-
Stage 1	468	-	-	-	-	-
Stage 2	539	-	-	-	-	-
Platoon blocked, %			-	-		
Mov Cap-1 Maneuver	161	412	-	-	865	-
Mov Cap-2 Maneuver	161	-	-	-	-	-
Stage 1	468	-	-	-	-	-
Stage 2	538	-	-	-	-	-

Approach	WB		NB		SB
HCM Control Delay, s	25.1		0		0
HCM LOS	D				

Minor Lane/Major Mvmt	NBT	NBRWBLn1	SBL	SBT
Capacity (veh/h)	-	- 202	865	-
HCM Lane V/C Ratio	-	- 0.113	0.001	-
HCM Control Delay (s)	-	- 25.1	9.2	0
HCM Lane LOS	-	- D	A	A
HCM 95th %tile Q(veh)	-	- 0.4	0	-

Intersection

Int Delay, s/veh 0.1

Movement	EBL	EBT	EBR	WBL	WBT	WBR	NBL	NBT	NBR	SBL	SBT	SBR
Lane Configurations		↔			↔		↖	↗		↖	↗	
Traffic Vol, veh/h	4	0	1	0	0	0	0	699	0	0	597	4
Future Vol, veh/h	4	0	1	0	0	0	0	699	0	0	597	4
Conflicting Peds, #/hr	1	0	0	0	0	1	1	0	1	1	0	1
Sign Control	Stop	Stop	Stop	Stop	Stop	Stop	Free	Free	Free	Free	Free	Free
RT Channelized	-	-	None	-	-	None	-	-	None	-	-	None
Storage Length	-	-	-	-	-	-	65	-	-	50	-	-
Veh in Median Storage, #	-	0	-	-	0	-	-	0	-	-	0	-
Grade, %	-	0	-	-	0	-	-	0	-	-	0	-
Peak Hour Factor	93	93	93	93	93	93	93	93	93	93	93	93
Heavy Vehicles, %	0	0	0	0	0	0	0	6	0	0	4	0
Mvmt Flow	4	0	1	0	0	0	0	752	0	0	642	4

Major/Minor	Minor2			Minor1			Major1			Major2		
Conflicting Flow All	1398	1398	645	1398	1400	754	647	0	0	753	0	0
Stage 1	645	645	-	753	753	-	-	-	-	-	-	-
Stage 2	753	753	-	645	647	-	-	-	-	-	-	-
Critical Hdwy	7.1	6.5	6.2	7.1	6.5	6.2	4.1	-	-	4.1	-	-
Critical Hdwy Stg 1	6.1	5.5	-	6.1	5.5	-	-	-	-	-	-	-
Critical Hdwy Stg 2	6.1	5.5	-	6.1	5.5	-	-	-	-	-	-	-
Follow-up Hdwy	3.5	4	3.3	3.5	4	3.3	2.2	-	-	2.2	-	-
Pot Cap-1 Maneuver	119	142	476	119	142	412	948	-	-	866	-	-
Stage 1	464	471	-	405	420	-	-	-	-	-	-	-
Stage 2	405	420	-	464	470	-	-	-	-	-	-	-
Platoon blocked, %												
Mov Cap-1 Maneuver	119	142	476	119	142	411	948	-	-	865	-	-
Mov Cap-2 Maneuver	119	142	-	119	142	-	-	-	-	-	-	-
Stage 1	464	471	-	405	420	-	-	-	-	-	-	-
Stage 2	405	420	-	463	470	-	-	-	-	-	-	-

Approach	EB	WB	NB	SB
HCM Control Delay, s	31.7	0	0	0
HCM LOS	D	A		

Minor Lane/Major Mvmt	NBL	NBT	NBR	EBLn1WBLn1	SBL	SBT	SBR
Capacity (veh/h)	948	-	-	140	-	865	-
HCM Lane V/C Ratio	-	-	-	0.038	-	-	-
HCM Control Delay (s)	0	-	-	31.7	0	0	-
HCM Lane LOS	A	-	-	D	A	A	-
HCM 95th %tile Q(veh)	0	-	-	0.1	-	0	-

Intersection

Int Delay, s/veh 0.8

Movement	WBL	WBR	NBT	NBR	SBL	SBT
Lane Configurations	↕		↔		↕	↕
Traffic Vol, veh/h	14	38	658	4	9	582
Future Vol, veh/h	14	38	658	4	9	582
Conflicting Peds, #/hr	0	0	0	0	0	0
Sign Control	Stop	Stop	Free	Free	Free	Free
RT Channelized	-	None	-	None	-	None
Storage Length	0	-	-	-	65	-
Veh in Median Storage, #	0	-	0	-	-	0
Grade, %	0	-	0	-	-	0
Peak Hour Factor	92	92	92	92	92	92
Heavy Vehicles, %	0	0	6	0	0	4
Mvmt Flow	15	41	715	4	10	633

Major/Minor	Minor1		Major1		Major2	
Conflicting Flow All	1369	717	0	0	720	0
Stage 1	717	-	-	-	-	-
Stage 2	652	-	-	-	-	-
Critical Hdwy	6.4	6.2	-	-	4.1	-
Critical Hdwy Stg 1	5.4	-	-	-	-	-
Critical Hdwy Stg 2	5.4	-	-	-	-	-
Follow-up Hdwy	3.5	3.3	-	-	2.2	-
Pot Cap-1 Maneuver	163	433	-	-	891	-
Stage 1	487	-	-	-	-	-
Stage 2	522	-	-	-	-	-
Platoon blocked, %			-	-		
Mov Cap-1 Maneuver	161	433	-	-	891	-
Mov Cap-2 Maneuver	161	-	-	-	-	-
Stage 1	487	-	-	-	-	-
Stage 2	516	-	-	-	-	-

Approach	WB		NB		SB
HCM Control Delay, s	19.9		0		0.1
HCM LOS	C				

Minor Lane/Major Mvmt	NBT	NBRWBLn1	SBL	SBT
Capacity (veh/h)	-	- 298	891	-
HCM Lane V/C Ratio	-	- 0.19	0.011	-
HCM Control Delay (s)	-	- 19.9	9.1	-
HCM Lane LOS	-	- C	A	-
HCM 95th %tile Q(veh)	-	- 0.7	0	-

Intersection						
Int Delay, s/veh	7.6					
Movement	WBL	WBR	NBT	NBR	SBL	SBT
Lane Configurations	Y		P			A
Traffic Vol, veh/h	1	22	1	0	5	1
Future Vol, veh/h	1	22	1	0	5	1
Conflicting Peds, #/hr	0	0	0	0	0	0
Sign Control	Stop	Stop	Free	Free	Free	Free
RT Channelized	-	None	-	None	-	None
Storage Length	0	-	-	-	-	-
Veh in Median Storage, #	0	-	0	-	-	0
Grade, %	0	-	0	-	-	0
Peak Hour Factor	75	75	75	75	75	75
Heavy Vehicles, %	0	0	0	0	0	0
Mvmt Flow	1	29	1	0	7	1
Major/Minor	Minor1	Major1		Major2		
Conflicting Flow All	16	1	0	0	1	0
Stage 1	1	-	-	-	-	-
Stage 2	15	-	-	-	-	-
Critical Hdwy	6.4	6.2	-	-	4.1	-
Critical Hdwy Stg 1	5.4	-	-	-	-	-
Critical Hdwy Stg 2	5.4	-	-	-	-	-
Follow-up Hdwy	3.5	3.3	-	-	2.2	-
Pot Cap-1 Maneuver	1008	1090	-	-	1635	-
Stage 1	1028	-	-	-	-	-
Stage 2	1013	-	-	-	-	-
Platoon blocked, %			-	-		-
Mov Cap-1 Maneuver	1004	1090	-	-	1635	-
Mov Cap-2 Maneuver	1004	-	-	-	-	-
Stage 1	1028	-	-	-	-	-
Stage 2	1009	-	-	-	-	-
Approach	WB	NB		SB		
HCM Control Delay, s	8.4	0		6		
HCM LOS	A					
Minor Lane/Major Mvmt	NBT	NBRWBLn1	SBL	SBT		
Capacity (veh/h)	-	- 1086	1635	-		
HCM Lane V/C Ratio	-	- 0.028	0.004	-		
HCM Control Delay (s)	-	- 8.4	7.2	0		
HCM Lane LOS	-	- A	A	A		
HCM 95th %tile Q(veh)	-	- 0.1	0	-		

Intersection

Int Delay, s/veh 5.7

Movement	EBT	EBR	WBL	WBT	NBL	NBR
Lane Configurations	↔		↔		↔	
Traffic Vol, veh/h	2	3	0	4	18	0
Future Vol, veh/h	2	3	0	4	18	0
Conflicting Peds, #/hr	0	0	0	0	0	1
Sign Control	Free	Free	Free	Free	Stop	Stop
RT Channelized	-	None	-	None	-	None
Storage Length	-	-	-	-	0	-
Veh in Median Storage, #	0	-	-	0	0	-
Grade, %	0	-	-	0	0	-
Peak Hour Factor	70	70	70	70	70	70
Heavy Vehicles, %	0	0	0	0	0	0
Mvmt Flow	3	4	0	6	26	0

Major/Minor	Major1		Major2		Minor1	
Conflicting Flow All	0	0	7	0	11	6
Stage 1	-	-	-	-	5	-
Stage 2	-	-	-	-	6	-
Critical Hdwy	-	-	4.1	-	6.4	6.2
Critical Hdwy Stg 1	-	-	-	-	5.4	-
Critical Hdwy Stg 2	-	-	-	-	5.4	-
Follow-up Hdwy	-	-	2.2	-	3.5	3.3
Pot Cap-1 Maneuver	-	-	1627	-	1014	1083
Stage 1	-	-	-	-	1023	-
Stage 2	-	-	-	-	1022	-
Platoon blocked, %	-	-	-	-	-	-
Mov Cap-1 Maneuver	-	-	1625	-	1014	1082
Mov Cap-2 Maneuver	-	-	-	-	1014	-
Stage 1	-	-	-	-	1023	-
Stage 2	-	-	-	-	1022	-

Approach	EB	WB	NB
HCM Control Delay, s	0	0	8.6
HCM LOS			A

Minor Lane/Major Mvmt	NBLn1	EBT	EBR	WBL	WBT
Capacity (veh/h)	1014	-	-	1625	-
HCM Lane V/C Ratio	0.025	-	-	-	-
HCM Control Delay (s)	8.6	-	-	0	-
HCM Lane LOS	A	-	-	A	-
HCM 95th %tile Q(veh)	0.1	-	-	0	-

Intersection

Int Delay, s/veh 0.6

Movement	EBL	EBT	EBR	WBL	WBT	WBR	NBL	NBT	NBR	SBL	SBT	SBR
Lane Configurations		↔			↔		↖	↗		↖	↗	
Traffic Vol, veh/h	3	0	5	2	0	26	4	635	4	10	579	0
Future Vol, veh/h	3	0	5	2	0	26	4	635	4	10	579	0
Conflicting Peds, #/hr	0	0	0	0	0	0	1	0	0	0	0	1
Sign Control	Stop	Stop	Stop	Stop	Stop	Stop	Free	Free	Free	Free	Free	Free
RT Channelized	-	-	None	-	-	None	-	-	None	-	-	None
Storage Length	-	-	-	-	-	-	125	-	-	125	-	-
Veh in Median Storage, #	-	0	-	-	0	-	-	0	-	-	0	-
Grade, %	-	0	-	-	0	-	-	0	-	-	0	-
Peak Hour Factor	90	90	90	90	90	90	90	90	90	90	90	90
Heavy Vehicles, %	0	0	0	0	0	4	0	6	0	0	4	0
Mvmt Flow	3	0	6	2	0	29	4	706	4	11	643	0

Major/Minor	Minor2			Minor1			Major1			Major2		
Conflicting Flow All	1398	1386	644	1385	1384	708	644	0	0	710	0	0
Stage 1	667	667	-	717	717	-	-	-	-	-	-	-
Stage 2	731	719	-	668	667	-	-	-	-	-	-	-
Critical Hdwy	7.1	6.5	6.2	7.1	6.5	6.24	4.1	-	-	4.1	-	-
Critical Hdwy Stg 1	6.1	5.5	-	6.1	5.5	-	-	-	-	-	-	-
Critical Hdwy Stg 2	6.1	5.5	-	6.1	5.5	-	-	-	-	-	-	-
Follow-up Hdwy	3.5	4	3.3	3.5	4	3.336	2.2	-	-	2.2	-	-
Pot Cap-1 Maneuver	119	144	476	122	145	431	951	-	-	899	-	-
Stage 1	451	460	-	424	437	-	-	-	-	-	-	-
Stage 2	416	436	-	451	460	-	-	-	-	-	-	-
Platoon blocked, %												
Mov Cap-1 Maneuver	110	142	476	119	142	431	951	-	-	899	-	-
Mov Cap-2 Maneuver	110	142	-	119	142	-	-	-	-	-	-	-
Stage 1	449	454	-	422	435	-	-	-	-	-	-	-
Stage 2	386	434	-	440	454	-	-	-	-	-	-	-

Approach	EB	WB	NB	SB
HCM Control Delay, s	22.7	15.8	0.1	0.2
HCM LOS	C	C		

Minor Lane/Major Mvmt	NBL	NBT	NBR	EBLn1WBLn1	SBL	SBT	SBR
Capacity (veh/h)	951	-	-	212	363	899	-
HCM Lane V/C Ratio	0.005	-	-	0.042	0.086	0.012	-
HCM Control Delay (s)	8.8	-	-	22.7	15.8	9.1	-
HCM Lane LOS	A	-	-	C	C	A	-
HCM 95th %tile Q(veh)	0	-	-	0.1	0.3	0	-

Intersection

Int Delay, s/veh 2.7

Movement	EBL	EBT	EBR	WBL	WBT	WBR	NBL	NBT	NBR	SBL	SBT	SBR
Lane Configurations		↔			↔		↔	↔		↔	↔	
Traffic Vol, veh/h	10	0	11	48	0	15	4	623	21	6	575	6
Future Vol, veh/h	10	0	11	48	0	15	4	623	21	6	575	6
Conflicting Peds, #/hr	0	0	0	0	0	0	1	0	0	0	0	1
Sign Control	Stop	Stop	Stop	Stop	Stop	Stop	Free	Free	Free	Free	Free	Free
RT Channelized	-	-	None	-	-	None	-	-	None	-	-	None
Storage Length	-	-	-	-	-	-	80	-	-	125	-	-
Veh in Median Storage, #	-	0	-	-	0	-	-	0	-	-	0	-
Grade, %	-	0	-	-	0	-	-	0	-	-	0	-
Peak Hour Factor	93	93	93	93	93	93	93	93	93	93	93	93
Heavy Vehicles, %	2	2	2	2	2	2	2	2	2	2	2	2
Mvmt Flow	11	0	12	52	0	16	4	670	23	6	618	6

Major/Minor	Minor2			Minor1			Major1			Major2		
Conflicting Flow All	1333	1336	623	1330	1329	681	626	0	0	692	0	0
Stage 1	635	635	-	690	690	-	-	-	-	-	-	-
Stage 2	698	701	-	640	639	-	-	-	-	-	-	-
Critical Hdwy	7.12	6.52	6.22	7.12	6.52	6.22	4.12	-	-	4.12	-	-
Critical Hdwy Stg 1	6.12	5.52	-	6.12	5.52	-	-	-	-	-	-	-
Critical Hdwy Stg 2	6.12	5.52	-	6.12	5.52	-	-	-	-	-	-	-
Follow-up Hdwy	3.518	4.018	3.318	3.518	4.018	3.318	2.218	-	-	2.218	-	-
Pot Cap-1 Maneuver	131	153	486	132	155	450	956	-	-	903	-	-
Stage 1	467	472	-	435	446	-	-	-	-	-	-	-
Stage 2	431	441	-	464	470	-	-	-	-	-	-	-
Platoon blocked, %												
Mov Cap-1 Maneuver	125	151	486	128	153	450	956	-	-	903	-	-
Mov Cap-2 Maneuver	125	151	-	128	153	-	-	-	-	-	-	-
Stage 1	465	468	-	433	444	-	-	-	-	-	-	-
Stage 2	414	439	-	450	466	-	-	-	-	-	-	-

Approach	EB	WB	NB	SB
HCM Control Delay, s	24.7	45.6	0.1	0.1
HCM LOS	C	E		

Minor Lane/Major Mvmt	NBL	NBT	NBR	EBLn1WBLn1	SBL	SBT	SBR
Capacity (veh/h)	956	-	-	205	154	903	-
HCM Lane V/C Ratio	0.004	-	-	0.11	0.44	0.007	-
HCM Control Delay (s)	8.8	-	-	24.7	45.6	9	-
HCM Lane LOS	A	-	-	C	E	A	-
HCM 95th %tile Q(veh)	0	-	-	0.4	2	0	-

Intersection

Int Delay, s/veh 1.6

Movement	EBL	EBT	EBR	WBL	WBT	WBR	NBL	NBT	NBR	SBL	SBT	SBR
Lane Configurations		↕			↕			↕			↕	
Traffic Vol, veh/h	6	16	0	1	65	0	3	2	0	2	2	3
Future Vol, veh/h	6	16	0	1	65	0	3	2	0	2	2	3
Conflicting Peds, #/hr	1	0	0	0	0	1	0	0	1	1	0	0
Sign Control	Free	Free	Free	Free	Free	Free	Stop	Stop	Stop	Stop	Stop	Stop
RT Channelized	-	-	None	-	-	None	-	-	None	-	-	None
Storage Length	-	-	-	-	-	-	-	-	-	-	-	-
Veh in Median Storage, #	-	0	-	-	0	-	-	0	-	-	0	-
Grade, %	-	0	-	-	0	-	-	0	-	-	0	-
Peak Hour Factor	74	74	74	74	74	74	74	74	74	74	74	74
Heavy Vehicles, %	0	0	0	0	0	0	33	0	0	0	0	0
Mvmt Flow	8	22	0	1	88	0	4	3	0	3	3	4

Major/Minor	Major1			Major2			Minor1			Minor2		
Conflicting Flow All	89	0	0	22	0	0	132	130	23	132	130	89
Stage 1	-	-	-	-	-	-	38	38	-	92	92	-
Stage 2	-	-	-	-	-	-	94	92	-	40	38	-
Critical Hdwy	4.1	-	-	4.1	-	-	7.43	6.5	6.2	7.1	6.5	6.2
Critical Hdwy Stg 1	-	-	-	-	-	-	6.43	5.5	-	6.1	5.5	-
Critical Hdwy Stg 2	-	-	-	-	-	-	6.43	5.5	-	6.1	5.5	-
Follow-up Hdwy	2.2	-	-	2.2	-	-	3.797	4	3.3	3.5	4	3.3
Pot Cap-1 Maneuver	1519	-	-	1607	-	-	773	764	1060	845	764	975
Stage 1	-	-	-	-	-	-	904	867	-	920	823	-
Stage 2	-	-	-	-	-	-	842	823	-	980	867	-
Platoon blocked, %	-	-	-	-	-	-	-	-	-	-	-	-
Mov Cap-1 Maneuver	1519	-	-	1605	-	-	764	759	1059	837	759	974
Mov Cap-2 Maneuver	-	-	-	-	-	-	764	759	-	837	759	-
Stage 1	-	-	-	-	-	-	899	863	-	915	821	-
Stage 2	-	-	-	-	-	-	835	821	-	971	863	-

Approach	EB	WB	NB	SB
HCM Control Delay, s	2	0.1	9.8	9.2
HCM LOS			A	A

Minor Lane/Major Mvmt	NBLn1	EBL	EBT	EBR	WBL	WBT	WBR	SBLn1
Capacity (veh/h)	762	1519	-	-	1605	-	-	864
HCM Lane V/C Ratio	0.009	0.005	-	-	0.001	-	-	0.011
HCM Control Delay (s)	9.8	7.4	0	-	7.2	0	-	9.2
HCM Lane LOS	A	A	A	-	A	A	-	A
HCM 95th %tile Q(veh)	0	0	-	-	0	-	-	0

Intersection

Int Delay, s/veh 7.7

Movement	EBL	EBT	EBR	WBL	WBT	WBR	NBL	NBT	NBR	SBL	SBT	SBR
Lane Configurations		↕			↕			↕			↕	
Traffic Vol, veh/h	0	14	0	1	65	9	2	17	0	1	4	0
Future Vol, veh/h	0	14	0	1	65	9	2	17	0	1	4	0
Conflicting Peds, #/hr	1	0	0	0	0	1	0	0	0	0	0	0
Sign Control	Stop	Stop	Stop	Stop	Stop	Stop	Free	Free	Free	Free	Free	Free
RT Channelized	-	-	None	-	-	None	-	-	None	-	-	None
Storage Length	-	-	-	-	-	-	-	-	-	-	-	-
Veh in Median Storage, #	-	0	-	-	0	-	-	0	-	-	0	-
Grade, %	-	0	-	-	0	-	-	0	-	-	0	-
Peak Hour Factor	83	83	83	83	83	83	83	83	83	83	83	83
Heavy Vehicles, %	0	0	0	0	0	0	0	6	0	0	0	0
Mvmt Flow	0	17	0	1	78	11	2	20	0	1	5	0

Major/Minor	Minor2			Minor1			Major1			Major2		
Conflicting Flow All	78	32	5	41	32	21	5	0	0	20	0	0
Stage 1	7	7	-	25	25	-	-	-	-	-	-	-
Stage 2	71	25	-	16	7	-	-	-	-	-	-	-
Critical Hdwy	7.1	6.5	6.2	7.1	6.5	6.2	4.1	-	-	4.1	-	-
Critical Hdwy Stg 1	6.1	5.5	-	6.1	5.5	-	-	-	-	-	-	-
Critical Hdwy Stg 2	6.1	5.5	-	6.1	5.5	-	-	-	-	-	-	-
Follow-up Hdwy	3.5	4	3.3	3.5	4	3.3	2.2	-	-	2.2	-	-
Pot Cap-1 Maneuver	916	865	1084	968	865	1062	1630	-	-	1609	-	-
Stage 1	1020	894	-	998	878	-	-	-	-	-	-	-
Stage 2	944	878	-	1009	894	-	-	-	-	-	-	-
Platoon blocked, %												
Mov Cap-1 Maneuver	842	863	1084	952	863	1061	1630	-	-	1607	-	-
Mov Cap-2 Maneuver	842	863	-	952	863	-	-	-	-	-	-	-
Stage 1	1019	893	-	997	877	-	-	-	-	-	-	-
Stage 2	849	877	-	989	893	-	-	-	-	-	-	-

Approach	EB	WB	NB	SB
HCM Control Delay, s	9.3	9.5	0.8	1.4
HCM LOS	A	A		

Minor Lane/Major Mvmt	NBL	NBT	NBR	EBLn1WBLn1	SBL	SBT	SBR
Capacity (veh/h)	1630	-	-	863 884	1607	-	-
HCM Lane V/C Ratio	0.001	-	-	0.02 0.102	0.001	-	-
HCM Control Delay (s)	7.2	0	-	9.3 9.5	7.2	0	-
HCM Lane LOS	A	A	-	A A	A	A	-
HCM 95th %tile Q(veh)	0	-	-	0.1 0.3	0	-	-

Intersection	
Intersection Delay, s/veh	7.2
Intersection LOS	A

Movement	EBU	EBL	EBT	EBR	WBU	WBL	WBT	WBR	NBU	NBL	NBT	NBR
Lane Configurations			↕				↕				↕	
Traffic Vol, veh/h	0	0	17	1	0	5	63	1	0	1	1	2
Future Vol, veh/h	0	0	17	1	0	5	63	1	0	1	1	2
Peak Hour Factor	0.92	0.90	0.90	0.90	0.92	0.90	0.90	0.90	0.92	0.90	0.90	0.90
Heavy Vehicles, %	2	0	6	0	2	0	0	0	2	0	0	0
Mvmt Flow	0	0	19	1	0	6	70	1	0	1	1	2
Number of Lanes	0	0	1	0	0	0	1	0	0	0	1	0

Approach	EB	WB	NB
Opposing Approach	WB	EB	SB
Opposing Lanes	1	1	1
Conflicting Approach Left	SB	NB	EB
Conflicting Lanes Left	1	1	1
Conflicting Approach Right	NB	SB	WB
Conflicting Lanes Right	1	1	1
HCM Control Delay	7.2	7.3	6.9
HCM LOS	A	A	A

Lane	NBLn1	EBLn1	WBLn1	SBLn1
Vol Left, %	25%	0%	7%	0%
Vol Thru, %	25%	94%	91%	0%
Vol Right, %	50%	6%	1%	100%
Sign Control	Stop	Stop	Stop	Stop
Traffic Vol by Lane	4	18	69	6
LT Vol	1	0	5	0
Through Vol	1	17	63	0
RT Vol	2	1	1	6
Lane Flow Rate	4	20	77	7
Geometry Grp	1	1	1	1
Degree of Util (X)	0.005	0.022	0.084	0.006
Departure Headway (Hd)	3.823	4.045	3.94	3.47
Convergence, Y/N	Yes	Yes	Yes	Yes
Cap	932	887	913	1026
Service Time	1.861	2.061	1.946	1.51
HCM Lane V/C Ratio	0.004	0.023	0.084	0.007
HCM Control Delay	6.9	7.2	7.3	6.5
HCM Lane LOS	A	A	A	A
HCM 95th-tile Q	0	0.1	0.3	0

Intersection

Intersection Delay, s/veh
 Intersection LOS

Movement	SBU	SBL	SBT	SBR
Lane Configurations			↕	
Traffic Vol, veh/h	0	0	0	6
Future Vol, veh/h	0	0	0	6
Peak Hour Factor	0.92	0.90	0.90	0.90
Heavy Vehicles, %	2	0	0	0
Mvmt Flow	0	0	0	7
Number of Lanes	0	0	1	0

Approach SB

Opposing Approach	NB
Opposing Lanes	1
Conflicting Approach Left	WB
Conflicting Lanes Left	1
Conflicting Approach Right	EB
Conflicting Lanes Right	1
HCM Control Delay	6.5
HCM LOS	A

Intersection

Int Delay, s/veh 0.2

Movement	EBL	EBR	NBL	NBT	SBT	SBR
Lane Configurations	Y			Y	Y	
Traffic Vol, veh/h	3	6	7	642	581	0
Future Vol, veh/h	3	6	7	642	581	0
Conflicting Peds, #/hr	0	0	1	0	0	1
Sign Control	Stop	Stop	Free	Free	Free	Free
RT Channelized	-	None	-	None	-	None
Storage Length	0	-	-	-	-	-
Veh in Median Storage, #	0	-	-	0	0	-
Grade, %	0	-	-	0	0	-
Peak Hour Factor	93	93	93	93	93	93
Heavy Vehicles, %	2	2	2	2	2	2
Mvmt Flow	3	6	8	690	625	0

Major/Minor	Minor2		Major1		Major2	
Conflicting Flow All	1331	626	626	0	-	0
Stage 1	626	-	-	-	-	-
Stage 2	705	-	-	-	-	-
Critical Hdwy	6.42	6.22	4.12	-	-	-
Critical Hdwy Stg 1	5.42	-	-	-	-	-
Critical Hdwy Stg 2	5.42	-	-	-	-	-
Follow-up Hdwy	3.518	3.318	2.218	-	-	-
Pot Cap-1 Maneuver	170	484	956	-	-	-
Stage 1	533	-	-	-	-	-
Stage 2	490	-	-	-	-	-
Platoon blocked, %				-	-	-
Mov Cap-1 Maneuver	167	484	956	-	-	-
Mov Cap-2 Maneuver	167	-	-	-	-	-
Stage 1	532	-	-	-	-	-
Stage 2	483	-	-	-	-	-

Approach	EB	NB	SB
HCM Control Delay, s	17.6	0.1	0
HCM LOS	C		

Minor Lane/Major Mvmt	NBL	NBT	EBLn1	SBT	SBR
Capacity (veh/h)	956	-	296	-	-
HCM Lane V/C Ratio	0.008	-	0.033	-	-
HCM Control Delay (s)	8.8	0	17.6	-	-
HCM Lane LOS	A	A	C	-	-
HCM 95th %tile Q(veh)	0	-	0.1	-	-

Intersection

Int Delay, s/veh 0.4

Movement	WBL	WBR	NBT	NBR	SBL	SBT
Lane Configurations	↘		↑	↗		↖
Traffic Vol, veh/h	11	5	678	18	5	878
Future Vol, veh/h	11	5	678	18	5	878
Conflicting Peds, #/hr	0	0	0	1	1	0
Sign Control	Stop	Stop	Free	Free	Free	Free
RT Channelized	-	None	-	None	-	None
Storage Length	0	-	-	125	-	-
Veh in Median Storage, #	0	-	0	-	-	0
Grade, %	0	-	0	-	-	0
Peak Hour Factor	95	95	95	95	95	95
Heavy Vehicles, %	0	0	2	0	0	2
Mvmt Flow	12	5	714	19	5	924

Major/Minor	Minor1		Major1		Major2	
Conflicting Flow All	1650	715	0	0	715	0
Stage 1	715	-	-	-	-	-
Stage 2	935	-	-	-	-	-
Critical Hdwy	6.4	6.2	-	-	4.1	-
Critical Hdwy Stg 1	5.4	-	-	-	-	-
Critical Hdwy Stg 2	5.4	-	-	-	-	-
Follow-up Hdwy	3.5	3.3	-	-	2.2	-
Pot Cap-1 Maneuver	110	434	-	-	895	-
Stage 1	488	-	-	-	-	-
Stage 2	385	-	-	-	-	-
Platoon blocked, %			-	-		
Mov Cap-1 Maneuver	109	434	-	-	895	-
Mov Cap-2 Maneuver	109	-	-	-	-	-
Stage 1	488	-	-	-	-	-
Stage 2	381	-	-	-	-	-

Approach	WB		NB		SB
HCM Control Delay, s	33.7		0		0.1
HCM LOS	D				

Minor Lane/Major Mvmt	NBT	NBRWBLn1	SBL	SBT
Capacity (veh/h)	-	- 142	895	-
HCM Lane V/C Ratio	-	- 0.119	0.006	-
HCM Control Delay (s)	-	- 33.7	9	0
HCM Lane LOS	-	- D	A	A
HCM 95th %tile Q(veh)	-	- 0.4	0	-

Intersection

Int Delay, s/veh 0.3

Movement	EBL	EBT	EBR	WBL	WBT	WBR	NBL	NBT	NBR	SBL	SBT	SBR
Lane Configurations		↔			↔		↖	↗		↖	↗	
Traffic Vol, veh/h	5	0	4	1	0	2	0	690	0	1	874	4
Future Vol, veh/h	5	0	4	1	0	2	0	690	0	1	874	4
Conflicting Peds, #/hr	5	0	0	0	0	5	0	0	4	4	0	0
Sign Control	Stop	Stop	Stop	Stop	Stop	Stop	Free	Free	Free	Free	Free	Free
RT Channelized	-	-	None	-	-	None	-	-	None	-	-	None
Storage Length	-	-	-	-	-	-	65	-	-	50	-	-
Veh in Median Storage, #	-	0	-	-	0	-	-	0	-	-	0	-
Grade, %	-	0	-	-	0	-	-	0	-	-	0	-
Peak Hour Factor	94	94	94	94	94	94	94	94	94	94	94	94
Heavy Vehicles, %	0	0	0	0	0	0	0	2	0	0	1	0
Mvmt Flow	5	0	4	1	0	2	0	734	0	1	930	4

Major/Minor	Minor2			Minor1			Major1			Major2		
Conflicting Flow All	1674	1672	932	1674	1674	743	934	0	0	738	0	0
Stage 1	934	934	-	738	738	-	-	-	-	-	-	-
Stage 2	740	738	-	936	936	-	-	-	-	-	-	-
Critical Hdwy	7.1	6.5	6.2	7.1	6.5	6.2	4.1	-	-	4.1	-	-
Critical Hdwy Stg 1	6.1	5.5	-	6.1	5.5	-	-	-	-	-	-	-
Critical Hdwy Stg 2	6.1	5.5	-	6.1	5.5	-	-	-	-	-	-	-
Follow-up Hdwy	3.5	4	3.3	3.5	4	3.3	2.2	-	-	2.2	-	-
Pot Cap-1 Maneuver	77	97	326	77	97	418	741	-	-	877	-	-
Stage 1	322	347	-	413	427	-	-	-	-	-	-	-
Stage 2	412	427	-	321	346	-	-	-	-	-	-	-
Platoon blocked, %												
Mov Cap-1 Maneuver	76	97	326	76	97	414	741	-	-	873	-	-
Mov Cap-2 Maneuver	76	97	-	76	97	-	-	-	-	-	-	-
Stage 1	322	347	-	411	425	-	-	-	-	-	-	-
Stage 2	408	425	-	316	346	-	-	-	-	-	-	-

Approach	EB	WB	NB	SB
HCM Control Delay, s	39.1	27	0	0
HCM LOS	E	D		

Minor Lane/Major Mvmt	NBL	NBT	NBR	EBLn1WBLn1	SBL	SBT	SBR
Capacity (veh/h)	741	-	-	115	167	873	-
HCM Lane V/C Ratio	-	-	-	0.083	0.019	0.001	-
HCM Control Delay (s)	0	-	-	39.1	27	9.1	-
HCM Lane LOS	A	-	-	E	D	A	-
HCM 95th %tile Q(veh)	0	-	-	0.3	0.1	0	-

Intersection

Int Delay, s/veh 0.6

Movement	WBL	WBR	NBT	NBR	SBL	SBT
Lane Configurations	↕		↗		↖	↗
Traffic Vol, veh/h	9	12	678	13	34	851
Future Vol, veh/h	9	12	678	13	34	851
Conflicting Peds, #/hr	0	0	0	2	2	0
Sign Control	Stop	Stop	Free	Free	Free	Free
RT Channelized	-	None	-	None	-	None
Storage Length	0	-	-	-	65	-
Veh in Median Storage, #	0	-	0	-	-	0
Grade, %	0	-	0	-	-	0
Peak Hour Factor	96	96	96	96	96	96
Heavy Vehicles, %	0	0	2	0	0	2
Mvmt Flow	9	13	706	14	35	886

Major/Minor	Minor1		Major1		Major2	
Conflicting Flow All	1672	715	0	0	722	0
Stage 1	715	-	-	-	-	-
Stage 2	957	-	-	-	-	-
Critical Hdwy	6.4	6.2	-	-	4.1	-
Critical Hdwy Stg 1	5.4	-	-	-	-	-
Critical Hdwy Stg 2	5.4	-	-	-	-	-
Follow-up Hdwy	3.5	3.3	-	-	2.2	-
Pot Cap-1 Maneuver	107	434	-	-	889	-
Stage 1	488	-	-	-	-	-
Stage 2	376	-	-	-	-	-
Platoon blocked, %			-	-		-
Mov Cap-1 Maneuver	103	433	-	-	889	-
Mov Cap-2 Maneuver	103	-	-	-	-	-
Stage 1	487	-	-	-	-	-
Stage 2	361	-	-	-	-	-

Approach	WB		NB		SB
HCM Control Delay, s	27.5		0		0.4
HCM LOS	D				

Minor Lane/Major Mvmt	NBT	NBRWBLn1	SBL	SBT
Capacity (veh/h)	-	-	182	889
HCM Lane V/C Ratio	-	-	0.12	0.04
HCM Control Delay (s)	-	-	27.5	9.2
HCM Lane LOS	-	-	D	A
HCM 95th %tile Q(veh)	-	-	0.4	0.1

Intersection

Int Delay, s/veh 6.3

Movement	WBL	WBR	NBT	NBR	SBL	SBT
Lane Configurations	Y		P			A
Traffic Vol, veh/h	4	6	1	6	19	0
Future Vol, veh/h	4	6	1	6	19	0
Conflicting Peds, #/hr	1	0	0	5	5	0
Sign Control	Stop	Stop	Free	Free	Free	Free
RT Channelized	-	None	-	None	-	None
Storage Length	0	-	-	-	-	-
Veh in Median Storage, #	0	-	0	-	-	0
Grade, %	0	-	0	-	-	0
Peak Hour Factor	75	75	75	75	75	75
Heavy Vehicles, %	0	17	0	0	0	0
Mvmt Flow	5	8	1	8	25	0

Major/Minor	Minor1		Major1		Major2	
Conflicting Flow All	62	10	0	0	14	0
Stage 1	10	-	-	-	-	-
Stage 2	52	-	-	-	-	-
Critical Hdwy	6.4	6.37	-	-	4.1	-
Critical Hdwy Stg 1	5.4	-	-	-	-	-
Critical Hdwy Stg 2	5.4	-	-	-	-	-
Follow-up Hdwy	3.5	3.453	-	-	2.2	-
Pot Cap-1 Maneuver	949	1029	-	-	1617	-
Stage 1	1018	-	-	-	-	-
Stage 2	976	-	-	-	-	-
Platoon blocked, %			-	-		-
Mov Cap-1 Maneuver	929	1024	-	-	1617	-
Mov Cap-2 Maneuver	929	-	-	-	-	-
Stage 1	1013	-	-	-	-	-
Stage 2	960	-	-	-	-	-

Approach	WB		NB		SB
HCM Control Delay, s	8.7		0		7.3
HCM LOS	A				

Minor Lane/Major Mvmt	NBT	NBR	WBLn1	SBL	SBT
Capacity (veh/h)	-	-	984	1617	-
HCM Lane V/C Ratio	-	-	0.014	0.016	-
HCM Control Delay (s)	-	-	8.7	7.3	0
HCM Lane LOS	-	-	A	A	A
HCM 95th %tile Q(veh)	-	-	0	0	-

Intersection

Int Delay, s/veh 2

Movement	EBT	EBR	WBL	WBT	NBL	NBR
Lane Configurations	↔		↔		↔	
Traffic Vol, veh/h	8	16	1	4	7	0
Future Vol, veh/h	8	16	1	4	7	0
Conflicting Peds, #/hr	0	3	3	0	1	0
Sign Control	Free	Free	Free	Free	Stop	Stop
RT Channelized	-	None	-	None	-	None
Storage Length	-	-	-	-	0	-
Veh in Median Storage, #	0	-	-	0	0	-
Grade, %	0	-	-	0	0	-
Peak Hour Factor	69	69	69	69	69	69
Heavy Vehicles, %	0	0	0	0	29	0
Mvmt Flow	12	23	1	6	10	0

Major/Minor	Major1	Major2	Minor1
Conflicting Flow All	0	38	36
Stage 1	-	-	26
Stage 2	-	-	10
Critical Hdwy	-	4.1	6.69
Critical Hdwy Stg 1	-	-	5.69
Critical Hdwy Stg 2	-	-	5.69
Follow-up Hdwy	-	2.2	3.761
Pot Cap-1 Maneuver	-	1585	912
Stage 1	-	-	931
Stage 2	-	-	947
Platoon blocked, %	-	-	-
Mov Cap-1 Maneuver	-	1585	908
Mov Cap-2 Maneuver	-	-	908
Stage 1	-	-	928
Stage 2	-	-	945

Approach	EB	WB	NB
HCM Control Delay, s	0	1.5	9
HCM LOS			A

Minor Lane/Major Mvmt	NBLn1	EBT	EBR	WBL	WBT
Capacity (veh/h)	908	-	-	1585	-
HCM Lane V/C Ratio	0.011	-	-	0.001	-
HCM Control Delay (s)	9	-	-	7.3	0
HCM Lane LOS	A	-	-	A	A
HCM 95th %tile Q(veh)	0	-	-	0	-

Intersection

Int Delay, s/veh 1

Movement	EBL	EBT	EBR	WBL	WBT	WBR	NBL	NBT	NBR	SBL	SBT	SBR
Lane Configurations		↔			↔		↑	↑		↑	↑	
Traffic Vol, veh/h	7	0	7	7	0	17	10	668	7	28	821	5
Future Vol, veh/h	7	0	7	7	0	17	10	668	7	28	821	5
Conflicting Peds, #/hr	0	0	0	0	0	0	0	0	2	2	0	0
Sign Control	Stop	Stop	Stop	Stop	Stop	Stop	Free	Free	Free	Free	Free	Free
RT Channelized	-	-	None	-	-	None	-	-	None	-	-	None
Storage Length	-	-	-	-	-	-	125	-	-	125	-	-
Veh in Median Storage, #	-	0	-	-	0	-	-	0	-	-	0	-
Grade, %	-	0	-	-	0	-	-	0	-	-	0	-
Peak Hour Factor	96	96	96	96	96	96	96	96	96	96	96	96
Heavy Vehicles, %	0	0	0	0	0	0	0	2	14	7	2	0
Mvmt Flow	7	0	7	7	0	18	10	696	7	29	855	5

Major/Minor	Minor2			Minor1			Major1			Major2		
Conflicting Flow All	1645	1642	858	1642	1641	701	860	0	0	705	0	0
Stage 1	916	916	-	722	722	-	-	-	-	-	-	-
Stage 2	729	726	-	920	919	-	-	-	-	-	-	-
Critical Hdwy	7.1	6.5	6.2	7.1	6.5	6.2	4.1	-	-	4.17	-	-
Critical Hdwy Stg 1	6.1	5.5	-	6.1	5.5	-	-	-	-	-	-	-
Critical Hdwy Stg 2	6.1	5.5	-	6.1	5.5	-	-	-	-	-	-	-
Follow-up Hdwy	3.5	4	3.3	3.5	4	3.3	2.2	-	-	2.263	-	-
Pot Cap-1 Maneuver	80	101	359	81	101	442	790	-	-	870	-	-
Stage 1	329	354	-	421	434	-	-	-	-	-	-	-
Stage 2	417	433	-	327	353	-	-	-	-	-	-	-
Platoon blocked, %												
Mov Cap-1 Maneuver	74	96	359	76	96	441	790	-	-	870	-	-
Mov Cap-2 Maneuver	74	96	-	76	96	-	-	-	-	-	-	-
Stage 1	325	342	-	415	428	-	-	-	-	-	-	-
Stage 2	395	427	-	310	341	-	-	-	-	-	-	-

Approach	EB	WB	NB	SB
HCM Control Delay, s	38.2	27.6	0.1	0.3
HCM LOS	E	D		

Minor Lane/Major Mvmt	NBL	NBT	NBR	EBLn1	WBLn1	SBL	SBT	SBR
Capacity (veh/h)	790	-	-	123	184	870	-	-
HCM Lane V/C Ratio	0.013	-	-	0.119	0.136	0.034	-	-
HCM Control Delay (s)	9.6	-	-	38.2	27.6	9.3	-	-
HCM Lane LOS	A	-	-	E	D	A	-	-
HCM 95th %tile Q(veh)	0	-	-	0.4	0.5	0.1	-	-

Intersection

Int Delay, s/veh 2.6

Movement	EBL	EBT	EBR	WBL	WBT	WBR	NBL	NBT	NBR	SBL	SBT	SBR
Lane Configurations		↔			↔		↔	↔		↔	↔	
Traffic Vol, veh/h	3	0	3	32	0	13	5	673	42	17	815	10
Future Vol, veh/h	3	0	3	32	0	13	5	673	42	17	815	10
Conflicting Peds, #/hr	1	0	0	0	0	1	1	0	0	0	0	1
Sign Control	Stop	Stop	Stop	Stop	Stop	Stop	Free	Free	Free	Free	Free	Free
RT Channelized	-	-	None	-	-	None	-	-	None	-	-	None
Storage Length	-	-	-	-	-	-	80	-	-	125	-	-
Veh in Median Storage, #	-	0	-	-	0	-	-	0	-	-	0	-
Grade, %	-	0	-	-	0	-	-	0	-	-	0	-
Peak Hour Factor	91	91	91	91	91	91	91	91	91	91	91	91
Heavy Vehicles, %	2	2	2	2	2	2	2	2	2	2	2	2
Mvmt Flow	3	0	3	35	0	14	5	740	46	19	896	11

Major/Minor	Minor2			Minor1			Major1			Major2		
Conflicting Flow All	1721	1736	902	1714	1719	764	908	0	0	786	0	0
Stage 1	939	939	-	774	774	-	-	-	-	-	-	-
Stage 2	782	797	-	940	945	-	-	-	-	-	-	-
Critical Hdwy	7.12	6.52	6.22	7.12	6.52	6.22	4.12	-	-	4.12	-	-
Critical Hdwy Stg 1	6.12	5.52	-	6.12	5.52	-	-	-	-	-	-	-
Critical Hdwy Stg 2	6.12	5.52	-	6.12	5.52	-	-	-	-	-	-	-
Follow-up Hdwy	3.518	4.018	3.318	3.518	4.018	3.318	2.218	-	-	2.218	-	-
Pot Cap-1 Maneuver	70	87	336	71	90	404	750	-	-	833	-	-
Stage 1	317	343	-	391	408	-	-	-	-	-	-	-
Stage 2	387	399	-	316	340	-	-	-	-	-	-	-
Platoon blocked, %												
Mov Cap-1 Maneuver	66	84	336	69	87	404	750	-	-	832	-	-
Mov Cap-2 Maneuver	66	84	-	69	87	-	-	-	-	-	-	-
Stage 1	315	335	-	388	405	-	-	-	-	-	-	-
Stage 2	370	396	-	306	332	-	-	-	-	-	-	-

Approach	EB	WB	NB	SB
HCM Control Delay, s	39.8	84.1	0.1	0.2
HCM LOS	E	F		

Minor Lane/Major Mvmt	NBL	NBT	NBR	EBLn1	WBLn1	SBL	SBT	SBR
Capacity (veh/h)	750	-	-	110	91	832	-	-
HCM Lane V/C Ratio	0.007	-	-	0.06	0.543	0.022	-	-
HCM Control Delay (s)	9.8	-	-	39.8	84.1	9.4	-	-
HCM Lane LOS	A	-	-	E	F	A	-	-
HCM 95th %tile Q(veh)	0	-	-	0.2	2.4	0.1	-	-

Intersection												
Int Delay, s/veh	3.9											

Movement	EBL	EBT	EBR	WBL	WBT	WBR	NBL	NBT	NBR	SBL	SBT	SBR
Lane Configurations		↕			↕			↕			↕	
Traffic Vol, veh/h	13	35	2	0	34	4	9	7	6	3	8	12
Future Vol, veh/h	13	35	2	0	34	4	9	7	6	3	8	12
Conflicting Peds, #/hr	2	0	1	1	0	2	0	0	0	0	0	0
Sign Control	Free	Free	Free	Free	Free	Free	Stop	Stop	Stop	Stop	Stop	Stop
RT Channelized	-	-	None	-	-	None	-	-	None	-	-	None
Storage Length	-	-	-	-	-	-	-	-	-	-	-	-
Veh in Median Storage, #	-	0	-	-	0	-	-	0	-	-	0	-
Grade, %	-	0	-	-	0	-	-	0	-	-	0	-
Peak Hour Factor	79	79	79	79	79	79	79	79	79	79	79	79
Heavy Vehicles, %	0	3	0	0	0	0	0	0	0	33	0	0
Mvmt Flow	16	44	3	0	43	5	11	9	8	4	10	15

Major/Minor	Major1			Major2			Minor1			Minor2		
Conflicting Flow All	50	0	0	48	0	0	137	129	47	135	129	48
Stage 1	-	-	-	-	-	-	79	79	-	48	48	-
Stage 2	-	-	-	-	-	-	58	50	-	87	81	-
Critical Hdwy	4.1	-	-	4.1	-	-	7.1	6.5	6.2	7.43	6.5	6.2
Critical Hdwy Stg 1	-	-	-	-	-	-	6.1	5.5	-	6.43	5.5	-
Critical Hdwy Stg 2	-	-	-	-	-	-	6.1	5.5	-	6.43	5.5	-
Follow-up Hdwy	2.2	-	-	2.2	-	-	3.5	4	3.3	3.797	4	3.3
Pot Cap-1 Maneuver	1570	-	-	1572	-	-	838	765	1028	770	765	1027
Stage 1	-	-	-	-	-	-	935	833	-	892	859	-
Stage 2	-	-	-	-	-	-	959	857	-	849	832	-
Platoon blocked, %	-	-	-	-	-	-	-	-	-	-	-	-
Mov Cap-1 Maneuver	1570	-	-	1572	-	-	810	755	1027	750	755	1025
Mov Cap-2 Maneuver	-	-	-	-	-	-	810	755	-	750	755	-
Stage 1	-	-	-	-	-	-	925	824	-	881	857	-
Stage 2	-	-	-	-	-	-	934	855	-	825	823	-

Approach	EB	WB	NB	SB
HCM Control Delay, s	1.9	0	9.4	9.3
HCM LOS			A	A

Minor Lane/Major Mvmt	NBLn1	EBL	EBT	EBR	WBL	WBT	WBR	SBLn1
Capacity (veh/h)	839	1570	-	-	1572	-	-	874
HCM Lane V/C Ratio	0.033	0.01	-	-	-	-	-	0.033
HCM Control Delay (s)	9.4	7.3	0	-	0	-	-	9.3
HCM Lane LOS	A	A	A	-	A	-	-	A
HCM 95th %tile Q(veh)	0.1	0	-	-	0	-	-	0.1

Intersection

Int Delay, s/veh 7.5

Movement	EBL	EBT	EBR	WBL	WBT	WBR	NBL	NBT	NBR	SBL	SBT	SBR
Lane Configurations		↕			↕			↕			↕	
Traffic Vol, veh/h	0	39	3	9	33	2	4	6	5	15	12	2
Future Vol, veh/h	0	39	3	9	33	2	4	6	5	15	12	2
Conflicting Peds, #/hr	3	0	0	0	0	3	3	0	2	2	0	3
Sign Control	Stop	Stop	Stop	Stop	Stop	Stop	Free	Free	Free	Free	Free	Free
RT Channelized	-	-	None	-	-	None	-	-	None	-	-	None
Storage Length	-	-	-	-	-	-	-	-	-	-	-	-
Veh in Median Storage, #	-	0	-	-	0	-	-	0	-	-	0	-
Grade, %	-	0	-	-	0	-	-	0	-	-	0	-
Peak Hour Factor	86	86	86	86	86	86	86	86	86	86	86	86
Heavy Vehicles, %	0	5	0	22	0	0	0	0	0	0	8	0
Mvmt Flow	0	45	3	10	38	2	5	7	6	17	14	2

Major/Minor	Minor2			Minor1			Major1			Major2		
Conflicting Flow All	96	77	18	95	75	15	19	0	0	15	0	0
Stage 1	53	53	-	21	21	-	-	-	-	-	-	-
Stage 2	43	24	-	74	54	-	-	-	-	-	-	-
Critical Hdwy	7.1	6.55	6.2	7.32	6.5	6.2	4.1	-	-	4.1	-	-
Critical Hdwy Stg 1	6.1	5.55	-	6.32	5.5	-	-	-	-	-	-	-
Critical Hdwy Stg 2	6.1	5.55	-	6.32	5.5	-	-	-	-	-	-	-
Follow-up Hdwy	3.5	4.045	3.3	3.698	4	3.3	2.2	-	-	2.2	-	-
Pot Cap-1 Maneuver	891	808	1066	842	819	1070	1611	-	-	1616	-	-
Stage 1	965	845	-	948	882	-	-	-	-	-	-	-
Stage 2	976	869	-	888	854	-	-	-	-	-	-	-
Platoon blocked, %												
Mov Cap-1 Maneuver	843	793	1063	793	804	1065	1611	-	-	1611	-	-
Mov Cap-2 Maneuver	843	793	-	793	804	-	-	-	-	-	-	-
Stage 1	959	833	-	943	878	-	-	-	-	-	-	-
Stage 2	926	865	-	828	842	-	-	-	-	-	-	-

Approach	EB	WB	NB	SB
HCM Control Delay, s	9.7	9.7	1.9	3.8
HCM LOS	A	A		

Minor Lane/Major Mvmt	NBL	NBT	NBR	EBLn1	WBLn1	SBL	SBT	SBR
Capacity (veh/h)	1611	-	-	808	811	1611	-	-
HCM Lane V/C Ratio	0.003	-	-	0.06	0.063	0.011	-	-
HCM Control Delay (s)	7.2	0	-	9.7	9.7	7.3	0	-
HCM Lane LOS	A	A	-	A	A	A	A	-
HCM 95th %tile Q(veh)	0	-	-	0.2	0.2	0	-	-

Intersection	
Intersection Delay, s/veh	7.3
Intersection LOS	A

Movement	EBU	EBL	EBT	EBR	WBU	WBL	WBT	WBR	NBU	NBL	NBT	NBR
Lane Configurations			↕				↕				↕	
Traffic Vol, veh/h	0	2	53	6	0	1	32	0	0	5	2	3
Future Vol, veh/h	0	2	53	6	0	1	32	0	0	5	2	3
Peak Hour Factor	0.92	0.75	0.75	0.75	0.92	0.75	0.75	0.75	0.92	0.75	0.75	0.75
Heavy Vehicles, %	2	0	4	0	2	0	0	0	2	40	0	0
Mvmt Flow	0	3	71	8	0	1	43	0	0	7	3	4
Number of Lanes	0	0	1	0	0	0	1	0	0	0	1	0

Approach	EB	WB	NB
Opposing Approach	WB	EB	SB
Opposing Lanes	1	1	1
Conflicting Approach Left	SB	NB	EB
Conflicting Lanes Left	1	1	1
Conflicting Approach Right	NB	SB	WB
Conflicting Lanes Right	1	1	1
HCM Control Delay	7.3	7.2	7.9
HCM LOS	A	A	A

Lane	NBLn1	EBLn1	WBLn1	SBLn1
Vol Left, %	50%	3%	3%	0%
Vol Thru, %	20%	87%	97%	0%
Vol Right, %	30%	10%	0%	100%
Sign Control	Stop	Stop	Stop	Stop
Traffic Vol by Lane	10	61	33	4
LT Vol	5	2	1	0
Through Vol	2	53	32	0
RT Vol	3	6	0	4
Lane Flow Rate	13	81	44	5
Geometry Grp	1	1	1	1
Degree of Util (X)	0.017	0.088	0.049	0.005
Departure Headway (Hd)	4.721	3.914	4	3.525
Convergence, Y/N	Yes	Yes	Yes	Yes
Cap	755	917	895	1006
Service Time	2.771	1.932	2.023	1.579
HCM Lane V/C Ratio	0.017	0.088	0.049	0.005
HCM Control Delay	7.9	7.3	7.2	6.6
HCM Lane LOS	A	A	A	A
HCM 95th-tile Q	0.1	0.3	0.2	0

Intersection

Intersection Delay, s/veh

Intersection LOS

Movement	SBU	SBL	SBT	SBR
Lane Configurations			↔	
Traffic Vol, veh/h	0	0	0	4
Future Vol, veh/h	0	0	0	4
Peak Hour Factor	0.92	0.75	0.75	0.75
Heavy Vehicles, %	2	0	0	0
Mvmt Flow	0	0	0	5
Number of Lanes	0	0	1	0

Approach SB

Opposing Approach	NB
Opposing Lanes	1
Conflicting Approach Left	WB
Conflicting Lanes Left	1
Conflicting Approach Right	EB
Conflicting Lanes Right	1
HCM Control Delay	6.6
HCM LOS	A

Intersection

Int Delay, s/veh 0.1

Movement	EBL	EBR	NBL	NBT	SBT	SBR
Lane Configurations	Y			Y	Y	
Traffic Vol, veh/h	1	2	8	704	844	1
Future Vol, veh/h	1	2	8	704	844	1
Conflicting Peds, #/hr	0	0	0	0	0	0
Sign Control	Stop	Stop	Free	Free	Free	Free
RT Channelized	-	None	-	None	-	None
Storage Length	0	-	-	-	-	-
Veh in Median Storage, #	0	-	-	0	0	-
Grade, %	0	-	-	0	0	-
Peak Hour Factor	91	91	91	91	91	92
Heavy Vehicles, %	2	2	2	2	2	2
Mvmt Flow	1	2	9	774	927	1

Major/Minor	Minor2		Major1		Major2	
Conflicting Flow All	1719	928	929	0	-	0
Stage 1	928	-	-	-	-	-
Stage 2	791	-	-	-	-	-
Critical Hdwy	6.42	6.22	4.12	-	-	-
Critical Hdwy Stg 1	5.42	-	-	-	-	-
Critical Hdwy Stg 2	5.42	-	-	-	-	-
Follow-up Hdwy	3.518	3.318	2.218	-	-	-
Pot Cap-1 Maneuver	99	325	736	-	-	-
Stage 1	385	-	-	-	-	-
Stage 2	447	-	-	-	-	-
Platoon blocked, %				-	-	-
Mov Cap-1 Maneuver	97	325	736	-	-	-
Mov Cap-2 Maneuver	97	-	-	-	-	-
Stage 1	385	-	-	-	-	-
Stage 2	438	-	-	-	-	-

Approach	EB	NB	SB
HCM Control Delay, s	25.1	0.1	0
HCM LOS	D		

Minor Lane/Major Mvmt	NBL	NBT	EBLn1	SBT	SBR
Capacity (veh/h)	736	-	182	-	-
HCM Lane V/C Ratio	0.012	-	0.018	-	-
HCM Control Delay (s)	9.9	0	25.1	-	-
HCM Lane LOS	A	A	D	-	-
HCM 95th %tile Q(veh)	0	-	0.1	-	-

Intersection

Int Delay, s/veh 0.2

Movement	WBL	WBR	NBT	NBR	SBL	SBT
Lane Configurations	↘		↑	↗		↖
Traffic Vol, veh/h	7	3	749	9	4	968
Future Vol, veh/h	7	3	749	9	4	968
Conflicting Peds, #/hr	0	0	0	1	1	0
Sign Control	Stop	Stop	Free	Free	Free	Free
RT Channelized	-	None	-	None	-	None
Storage Length	0	-	-	125	-	-
Veh in Median Storage, #	0	-	0	-	-	0
Grade, %	0	-	0	-	-	0
Peak Hour Factor	96	96	96	96	96	96
Heavy Vehicles, %	0	0	2	0	0	1
Mvmt Flow	7	3	780	9	4	1008

Major/Minor	Minor1		Major1		Major2	
Conflicting Flow All	1798	781	0	0	781	0
Stage 1	781	-	-	-	-	-
Stage 2	1017	-	-	-	-	-
Critical Hdwy	6.4	6.2	-	-	4.1	-
Critical Hdwy Stg 1	5.4	-	-	-	-	-
Critical Hdwy Stg 2	5.4	-	-	-	-	-
Follow-up Hdwy	3.5	3.3	-	-	2.2	-
Pot Cap-1 Maneuver	89	398	-	-	845	-
Stage 1	455	-	-	-	-	-
Stage 2	352	-	-	-	-	-
Platoon blocked, %			-	-		
Mov Cap-1 Maneuver	88	398	-	-	845	-
Mov Cap-2 Maneuver	88	-	-	-	-	-
Stage 1	455	-	-	-	-	-
Stage 2	348	-	-	-	-	-

Approach	WB		NB		SB
HCM Control Delay, s	39.4		0		0
HCM LOS	E				

Minor Lane/Major Mvmt	NBT	NBRWBLn1	SBL	SBT
Capacity (veh/h)	-	- 115	845	-
HCM Lane V/C Ratio	-	- 0.091	0.005	-
HCM Control Delay (s)	-	- 39.4	9.3	0
HCM Lane LOS	-	- E	A	A
HCM 95th %tile Q(veh)	-	- 0.3	0	-

Intersection												
Int Delay, s/veh	0											
Movement	EBL	EBT	EBR	WBL	WBT	WBR	NBL	NBT	NBR	SBL	SBT	SBR
Lane Configurations		↕			↕		↕	↕		↕	↕	
Traffic Vol, veh/h	0	0	0	1	0	1	2	748	0	1	977	4
Future Vol, veh/h	0	0	0	1	0	1	2	748	0	1	977	4
Conflicting Peds, #/hr	0	0	1	1	0	0	0	0	3	3	0	0
Sign Control	Stop	Stop	Stop	Stop	Stop	Stop	Free	Free	Free	Free	Free	Free
RT Channelized	-	-	None	-	-	None	-	-	None	-	-	None
Storage Length	-	-	-	-	-	-	65	-	-	50	-	-
Veh in Median Storage, #	-	0	-	-	0	-	-	0	-	-	0	-
Grade, %	-	0	-	-	0	-	-	0	-	-	0	-
Peak Hour Factor	96	96	96	96	96	96	96	96	96	96	96	96
Heavy Vehicles, %	0	0	0	0	0	0	0	3	0	0	2	0
Mvmt Flow	0	0	0	1	0	1	2	779	0	1	1018	4
Major/Minor	Minor2			Minor1			Major1			Major2		
Conflicting Flow All	1806	1808	1021	1809	1810	782	1022	0	0	782	0	0
Stage 1	1022	1022	-	786	786	-	-	-	-	-	-	-
Stage 2	784	786	-	1023	1024	-	-	-	-	-	-	-
Critical Hdwy	7.1	6.5	6.2	7.1	6.5	6.2	4.1	-	-	4.1	-	-
Critical Hdwy Stg 1	6.1	5.5	-	6.1	5.5	-	-	-	-	-	-	-
Critical Hdwy Stg 2	6.1	5.5	-	6.1	5.5	-	-	-	-	-	-	-
Follow-up Hdwy	3.5	4	3.3	3.5	4	3.3	2.2	-	-	2.2	-	-
Pot Cap-1 Maneuver	62	80	289	62	80	397	687	-	-	845	-	-
Stage 1	287	316	-	388	406	-	-	-	-	-	-	-
Stage 2	389	406	-	287	315	-	-	-	-	-	-	-
Platoon blocked, %												
Mov Cap-1 Maneuver	62	79	289	62	79	396	686	-	-	845	-	-
Mov Cap-2 Maneuver	62	79	-	62	79	-	-	-	-	-	-	-
Stage 1	286	316	-	386	404	-	-	-	-	-	-	-
Stage 2	387	404	-	286	315	-	-	-	-	-	-	-
Approach	EB			WB			NB			SB		
HCM Control Delay, s	0			39.3			0			0		
HCM LOS	A			E								
Minor Lane/Major Mvmt	NBL	NBT	NBR	EBLn1	WBLn1	SBL	SBT	SBR				
Capacity (veh/h)	686	-	-	-	107	845	-	-				
HCM Lane V/C Ratio	0.003	-	-	-	0.019	0.001	-	-				
HCM Control Delay (s)	10.3	-	-	0	39.3	9.3	-	-				
HCM Lane LOS	B	-	-	A	E	A	-	-				
HCM 95th %tile Q(veh)	0	-	-	-	0.1	0	-	-				

Intersection

Int Delay, s/veh 0.6

Movement	WBL	WBR	NBT	NBR	SBL	SBT
Lane Configurations	↕		↔		↕	↕
Traffic Vol, veh/h	10	19	734	8	19	958
Future Vol, veh/h	10	19	734	8	19	958
Conflicting Peds, #/hr	0	0	0	1	1	0
Sign Control	Stop	Stop	Free	Free	Free	Free
RT Channelized	-	None	-	None	-	None
Storage Length	0	-	-	-	65	-
Veh in Median Storage, #	0	-	0	-	-	0
Grade, %	0	-	0	-	-	0
Peak Hour Factor	93	93	93	93	93	93
Heavy Vehicles, %	0	9	2	0	0	1
Mvmt Flow	11	20	789	9	20	1030

Major/Minor	Minor1		Major1		Major2	
Conflicting Flow All	1866	795	0	0	799	0
Stage 1	795	-	-	-	-	-
Stage 2	1071	-	-	-	-	-
Critical Hdwy	6.4	6.29	-	-	4.1	-
Critical Hdwy Stg 1	5.4	-	-	-	-	-
Critical Hdwy Stg 2	5.4	-	-	-	-	-
Follow-up Hdwy	3.5	3.381	-	-	2.2	-
Pot Cap-1 Maneuver	81	377	-	-	833	-
Stage 1	448	-	-	-	-	-
Stage 2	332	-	-	-	-	-
Platoon blocked, %			-	-		-
Mov Cap-1 Maneuver	79	377	-	-	833	-
Mov Cap-2 Maneuver	79	-	-	-	-	-
Stage 1	448	-	-	-	-	-
Stage 2	324	-	-	-	-	-

Approach	WB		NB		SB
HCM Control Delay, s	32		0		0.2
HCM LOS	D				

Minor Lane/Major Mvmt	NBT	NBRWBLn1	SBL	SBT
Capacity (veh/h)	-	- 164	833	-
HCM Lane V/C Ratio	-	- 0.19	0.025	-
HCM Control Delay (s)	-	- 32	9.4	-
HCM Lane LOS	-	- D	A	-
HCM 95th %tile Q(veh)	-	- 0.7	0.1	-

Intersection

Int Delay, s/veh 6.7

Movement	WBL	WBR	NBT	NBR	SBL	SBT
Lane Configurations	Y		P			A
Traffic Vol, veh/h	3	13	1	2	6	2
Future Vol, veh/h	3	13	1	2	6	2
Conflicting Peds, #/hr	2	0	0	0	0	0
Sign Control	Stop	Stop	Free	Free	Free	Free
RT Channelized	-	None	-	None	-	None
Storage Length	0	-	-	-	-	-
Veh in Median Storage, #	0	-	0	-	-	0
Grade, %	0	-	0	-	-	0
Peak Hour Factor	75	75	75	75	75	75
Heavy Vehicles, %	33	8	0	0	0	0
Mvmt Flow	4	17	1	3	8	3

Major/Minor	Minor1		Major1		Major2	
Conflicting Flow All	24	3	0	0	4	0
Stage 1	3	-	-	-	-	-
Stage 2	21	-	-	-	-	-
Critical Hdwy	6.73	6.28	-	-	4.1	-
Critical Hdwy Stg 1	5.73	-	-	-	-	-
Critical Hdwy Stg 2	5.73	-	-	-	-	-
Follow-up Hdwy	3.797	3.372	-	-	2.2	-
Pot Cap-1 Maneuver	918	1064	-	-	1631	-
Stage 1	945	-	-	-	-	-
Stage 2	927	-	-	-	-	-
Platoon blocked, %			-	-		-
Mov Cap-1 Maneuver	912	1064	-	-	1631	-
Mov Cap-2 Maneuver	912	-	-	-	-	-
Stage 1	945	-	-	-	-	-
Stage 2	921	-	-	-	-	-

Approach	WB		NB		SB
HCM Control Delay, s	8.6		0		5.4
HCM LOS	A				

Minor Lane/Major Mvmt	NBT	NBRWBLn1	SBL	SBT
Capacity (veh/h)	-	- 1032	1631	-
HCM Lane V/C Ratio	-	- 0.021	0.005	-
HCM Control Delay (s)	-	- 8.6	7.2	0
HCM Lane LOS	-	- A	A	A
HCM 95th %tile Q(veh)	-	- 0.1	0	-

Intersection

Int Delay, s/veh 5.9

Movement	EBT	EBR	WBL	WBT	NBL	NBR
Lane Configurations	↔		↔		↔	
Traffic Vol, veh/h	2	5	1	0	13	1
Future Vol, veh/h	2	5	1	0	13	1
Conflicting Peds, #/hr	0	1	1	0	0	0
Sign Control	Free	Free	Free	Free	Stop	Stop
RT Channelized	-	None	-	None	-	None
Storage Length	-	-	-	-	0	-
Veh in Median Storage, #	0	-	-	0	0	-
Grade, %	0	-	-	0	0	-
Peak Hour Factor	79	79	79	79	79	79
Heavy Vehicles, %	0	0	100	0	15	0
Mvmt Flow	3	6	1	0	16	1

Major/Minor	Major1		Major2		Minor1	
Conflicting Flow All	0	0	10	0	10	7
Stage 1	-	-	-	-	7	-
Stage 2	-	-	-	-	3	-
Critical Hdwy	-	-	5.1	-	6.55	6.2
Critical Hdwy Stg 1	-	-	-	-	5.55	-
Critical Hdwy Stg 2	-	-	-	-	5.55	-
Follow-up Hdwy	-	-	3.1	-	3.635	3.3
Pot Cap-1 Maneuver	-	-	1150	-	977	1081
Stage 1	-	-	-	-	983	-
Stage 2	-	-	-	-	987	-
Platoon blocked, %	-	-	-	-	-	-
Mov Cap-1 Maneuver	-	-	1150	-	975	1080
Mov Cap-2 Maneuver	-	-	-	-	975	-
Stage 1	-	-	-	-	982	-
Stage 2	-	-	-	-	986	-

Approach	EB	WB	NB
HCM Control Delay, s	0	8.1	8.7
HCM LOS			A

Minor Lane/Major Mvmt	NBLn1	EBT	EBR	WBL	WBT
Capacity (veh/h)	982	-	-	1150	-
HCM Lane V/C Ratio	0.018	-	-	0.001	-
HCM Control Delay (s)	8.7	-	-	8.1	0
HCM Lane LOS	A	-	-	A	A
HCM 95th %tile Q(veh)	0.1	-	-	0	-

Intersection

Int Delay, s/veh 0.8

Movement	EBL	EBT	EBR	WBL	WBT	WBR	NBL	NBT	NBR	SBL	SBT	SBR
Lane Configurations		↕			↕		↕	↕		↕	↕	
Traffic Vol, veh/h	0	0	6	6	1	25	9	721	2	22	938	5
Future Vol, veh/h	0	0	6	6	1	25	9	721	2	22	938	5
Conflicting Peds, #/hr	0	0	0	0	0	0	0	0	1	1	0	0
Sign Control	Stop	Stop	Stop	Stop	Stop	Stop	Free	Free	Free	Free	Free	Free
RT Channelized	-	-	None	-	-	None	-	-	None	-	-	None
Storage Length	-	-	-	-	-	-	125	-	-	125	-	-
Veh in Median Storage, #	-	0	-	-	0	-	-	0	-	-	0	-
Grade, %	-	0	-	-	0	-	-	0	-	-	0	-
Peak Hour Factor	95	95	95	95	95	95	95	95	95	95	95	95
Heavy Vehicles, %	0	0	0	17	0	4	0	3	0	5	1	0
Mvmt Flow	0	0	6	6	1	26	9	759	2	23	987	5

Major/Minor	Minor2			Minor1			Major1			Major2		
Conflicting Flow All	1829	1817	990	1819	1819	761	993	0	0	762	0	0
Stage 1	1036	1036	-	780	780	-	-	-	-	-	-	-
Stage 2	793	781	-	1039	1039	-	-	-	-	-	-	-
Critical Hdwy	7.1	6.5	6.2	7.27	6.5	6.24	4.1	-	-	4.15	-	-
Critical Hdwy Stg 1	6.1	5.5	-	6.27	5.5	-	-	-	-	-	-	-
Critical Hdwy Stg 2	6.1	5.5	-	6.27	5.5	-	-	-	-	-	-	-
Follow-up Hdwy	3.5	4	3.3	3.653	4	3.336	2.2	-	-	2.245	-	-
Pot Cap-1 Maneuver	60	79	302	55	79	402	704	-	-	837	-	-
Stage 1	282	311	-	367	409	-	-	-	-	-	-	-
Stage 2	385	408	-	261	310	-	-	-	-	-	-	-
Platoon blocked, %												
Mov Cap-1 Maneuver	54	76	302	52	76	402	704	-	-	837	-	-
Mov Cap-2 Maneuver	54	76	-	52	76	-	-	-	-	-	-	-
Stage 1	278	302	-	362	403	-	-	-	-	-	-	-
Stage 2	354	402	-	249	301	-	-	-	-	-	-	-

Approach	EB	WB	NB	SB
HCM Control Delay, s	17.2	31.7	0.1	0.2
HCM LOS	C	D		

Minor Lane/Major Mvmt	NBL	NBT	NBR	EBLn1WBLn1	SBL	SBT	SBR
Capacity (veh/h)	704	-	-	302	168	837	-
HCM Lane V/C Ratio	0.013	-	-	0.021	0.201	0.028	-
HCM Control Delay (s)	10.2	-	-	17.2	31.7	9.4	-
HCM Lane LOS	B	-	-	C	D	A	-
HCM 95th %tile Q(veh)	0	-	-	0.1	0.7	0.1	-

Intersection

Int Delay, s/veh 3.4

Movement	EBL	EBT	EBR	WBL	WBT	WBR	NBL	NBT	NBR	SBL	SBT	SBR
Lane Configurations		↔			↔		↔	↔		↔	↔	
Traffic Vol, veh/h	6	3	21	23	3	23	28	705	36	7	938	7
Future Vol, veh/h	6	3	21	23	3	23	28	705	36	7	938	7
Conflicting Peds, #/hr	1	0	0	0	0	1	0	0	0	0	0	0
Sign Control	Stop	Stop	Stop	Stop	Stop	Stop	Free	Free	Free	Free	Free	Free
RT Channelized	-	-	None	-	-	None	-	-	None	-	-	None
Storage Length	-	-	-	-	-	-	80	-	-	125	-	-
Veh in Median Storage, #	-	0	-	-	0	-	-	0	-	-	0	-
Grade, %	-	0	-	-	0	-	-	0	-	-	0	-
Peak Hour Factor	95	95	95	95	95	95	95	95	95	95	95	95
Heavy Vehicles, %	2	2	2	2	2	2	2	2	2	2	2	2
Mvmt Flow	6	3	22	24	3	24	29	742	38	7	987	7

Major/Minor	Minor2			Minor1			Major1			Major2		
Conflicting Flow All	1841	1845	991	1838	1829	762	995	0	0	780	0	0
Stage 1	1006	1006	-	820	820	-	-	-	-	-	-	-
Stage 2	835	839	-	1018	1009	-	-	-	-	-	-	-
Critical Hdwy	7.12	6.52	6.22	7.12	6.52	6.22	4.12	-	-	4.12	-	-
Critical Hdwy Stg 1	6.12	5.52	-	6.12	5.52	-	-	-	-	-	-	-
Critical Hdwy Stg 2	6.12	5.52	-	6.12	5.52	-	-	-	-	-	-	-
Follow-up Hdwy	3.518	4.018	3.318	3.518	4.018	3.318	2.218	-	-	2.218	-	-
Pot Cap-1 Maneuver	58	75	299	58	77	405	695	-	-	837	-	-
Stage 1	291	319	-	369	389	-	-	-	-	-	-	-
Stage 2	362	381	-	286	318	-	-	-	-	-	-	-
Platoon blocked, %												
Mov Cap-1 Maneuver	51	71	299	50	73	405	695	-	-	836	-	-
Mov Cap-2 Maneuver	51	71	-	50	73	-	-	-	-	-	-	-
Stage 1	279	316	-	354	373	-	-	-	-	-	-	-
Stage 2	323	365	-	260	315	-	-	-	-	-	-	-

Approach	EB	WB	NB	SB
HCM Control Delay, s	41.4	92.3	0.4	0.1
HCM LOS	E	F		

Minor Lane/Major Mvmt	NBL	NBT	NBR	EBLn1	WBLn1	SBL	SBT	SBR
Capacity (veh/h)	695	-	-	130	88	836	-	-
HCM Lane V/C Ratio	0.042	-	-	0.243	0.586	0.009	-	-
HCM Control Delay (s)	10.4	-	-	41.4	92.3	9.3	-	-
HCM Lane LOS	B	-	-	E	F	A	-	-
HCM 95th %tile Q(veh)	0.1	-	-	0.9	2.7	0	-	-

Intersection

Int Delay, s/veh 4.5

Movement	EBL	EBT	EBR	WBL	WBT	WBR	NBL	NBT	NBR	SBL	SBT	SBR
Lane Configurations		↕			↕			↕			↕	
Traffic Vol, veh/h	25	33	2	5	31	17	10	9	3	6	17	8
Future Vol, veh/h	25	33	2	5	31	17	10	9	3	6	17	8
Conflicting Peds, #/hr	1	0	0	0	0	1	0	0	2	2	0	0
Sign Control	Free	Free	Free	Free	Free	Free	Stop	Stop	Stop	Stop	Stop	Stop
RT Channelized	-	-	None	-	-	None	-	-	None	-	-	None
Storage Length	-	-	-	-	-	-	-	-	-	-	-	-
Veh in Median Storage, #	-	0	-	-	0	-	-	0	-	-	0	-
Grade, %	-	0	-	-	0	-	-	0	-	-	0	-
Peak Hour Factor	83	83	83	83	83	83	83	83	83	83	83	83
Heavy Vehicles, %	0	0	0	0	0	0	0	0	0	0	0	0
Mvmt Flow	30	40	2	6	37	20	12	11	4	7	20	10

Major/Minor	Major1	Major2	Minor1	Minor2								
Conflicting Flow All	59	0	0	42	0	0	176	172	43	171	163	49
Stage 1	-	-	-	-	-	-	101	101	-	61	61	-
Stage 2	-	-	-	-	-	-	75	71	-	110	102	-
Critical Hdwy	4.1	-	-	4.1	-	-	7.1	6.5	6.2	7.1	6.5	6.2
Critical Hdwy Stg 1	-	-	-	-	-	-	6.1	5.5	-	6.1	5.5	-
Critical Hdwy Stg 2	-	-	-	-	-	-	6.1	5.5	-	6.1	5.5	-
Follow-up Hdwy	2.2	-	-	2.2	-	-	3.5	4	3.3	3.5	4	3.3
Pot Cap-1 Maneuver	1558	-	-	1580	-	-	791	725	1033	797	733	1025
Stage 1	-	-	-	-	-	-	910	815	-	955	848	-
Stage 2	-	-	-	-	-	-	939	840	-	900	815	-
Platoon blocked, %	-	-	-	-	-	-	-	-	-	-	-	-
Mov Cap-1 Maneuver	1558	-	-	1577	-	-	752	707	1031	768	715	1024
Mov Cap-2 Maneuver	-	-	-	-	-	-	752	707	-	768	715	-
Stage 1	-	-	-	-	-	-	892	799	-	935	844	-
Stage 2	-	-	-	-	-	-	904	836	-	865	799	-

Approach	EB	WB	NB	SB
HCM Control Delay, s	3.1	0.7	9.9	9.8
HCM LOS			A	A

Minor Lane/Major Mvmt	NBLn1	EBL	EBT	EBR	WBL	WBT	WBR	SBLn1
Capacity (veh/h)	760	1558	-	-	1577	-	-	787
HCM Lane V/C Ratio	0.035	0.019	-	-	0.004	-	-	0.047
HCM Control Delay (s)	9.9	7.4	0	-	7.3	0	-	9.8
HCM Lane LOS	A	A	A	-	A	A	-	A
HCM 95th %tile Q(veh)	0.1	0.1	-	-	0	-	-	0.1

Intersection												
Int Delay, s/veh	6.9											
Movement	EBL	EBT	EBR	WBL	WBT	WBR	NBL	NBT	NBR	SBL	SBT	SBR
Lane Configurations		↕			↕			↕			↕	
Traffic Vol, veh/h	2	37	3	10	37	2	7	13	7	8	16	3
Future Vol, veh/h	2	37	3	10	37	2	7	13	7	8	16	3
Conflicting Peds, #/hr	4	0	0	0	0	4	1	0	1	1	0	1
Sign Control	Stop	Stop	Stop	Stop	Stop	Stop	Free	Free	Free	Free	Free	Free
RT Channelized	-	-	None	-	-	None	-	-	None	-	-	None
Storage Length	-	-	-	-	-	-	-	-	-	-	-	-
Veh in Median Storage, #	-	0	-	-	0	-	-	0	-	-	0	-
Grade, %	-	0	-	-	0	-	-	0	-	-	0	-
Peak Hour Factor	84	84	84	84	84	84	84	84	84	84	84	84
Heavy Vehicles, %	0	0	0	0	0	0	0	8	14	0	6	0
Mvmt Flow	2	44	4	12	44	2	8	15	8	10	19	4
Major/Minor	Minor2			Minor1			Major1			Major2		
Conflicting Flow All	105	82	22	101	80	25	24	0	0	25	0	0
Stage 1	41	41	-	37	37	-	-	-	-	-	-	-
Stage 2	64	41	-	64	43	-	-	-	-	-	-	-
Critical Hdwy	7.1	6.5	6.2	7.1	6.5	6.2	4.1	-	-	4.1	-	-
Critical Hdwy Stg 1	6.1	5.5	-	6.1	5.5	-	-	-	-	-	-	-
Critical Hdwy Stg 2	6.1	5.5	-	6.1	5.5	-	-	-	-	-	-	-
Follow-up Hdwy	3.5	4	3.3	3.5	4	3.3	2.2	-	-	2.2	-	-
Pot Cap-1 Maneuver	880	812	1061	885	814	1057	1604	-	-	1603	-	-
Stage 1	979	865	-	984	868	-	-	-	-	-	-	-
Stage 2	952	865	-	952	863	-	-	-	-	-	-	-
Platoon blocked, %												
Mov Cap-1 Maneuver	830	802	1060	837	804	1052	1604	-	-	1597	-	-
Mov Cap-2 Maneuver	830	802	-	837	804	-	-	-	-	-	-	-
Stage 1	973	859	-	978	863	-	-	-	-	-	-	-
Stage 2	893	860	-	895	857	-	-	-	-	-	-	-
Approach	EB			WB			NB			SB		
HCM Control Delay, s	9.7			9.7			1.9			2.2		
HCM LOS	A			A								
Minor Lane/Major Mvmt	NBL	NBT	NBR	EBLn1	WBLn1	SBL	SBT	SBR				
Capacity (veh/h)	1604	-	-	818	818	1597	-	-				
HCM Lane V/C Ratio	0.005	-	-	0.061	0.071	0.006	-	-				
HCM Control Delay (s)	7.3	0	-	9.7	9.7	7.3	0	-				
HCM Lane LOS	A	A	-	A	A	A	A	-				
HCM 95th %tile Q(veh)	0	-	-	0.2	0.2	0	-	-				

Intersection	
Intersection Delay, s/veh	7.2
Intersection LOS	A

Movement	EBU	EBL	EBT	EBR	WBU	WBL	WBT	WBR	NBU	NBL	NBT	NBR
Lane Configurations			↕				↕				↕	
Traffic Vol, veh/h	0	4	45	3	0	2	40	0	0	4	1	4
Future Vol, veh/h	0	4	45	3	0	2	40	0	0	4	1	4
Peak Hour Factor	0.92	0.83	0.83	0.83	0.92	0.83	0.83	0.83	0.92	0.83	0.83	0.83
Heavy Vehicles, %	2	0	2	0	2	0	0	0	2	0	0	0
Mvmt Flow	0	5	54	4	0	2	48	0	0	5	1	5
Number of Lanes	0	0	1	0	0	0	1	0	0	0	1	0

Approach	EB	WB	NB
Opposing Approach	WB	EB	SB
Opposing Lanes	1	1	1
Conflicting Approach Left	SB	NB	EB
Conflicting Lanes Left	1	1	1
Conflicting Approach Right	NB	SB	WB
Conflicting Lanes Right	1	1	1
HCM Control Delay	7.3	7.2	7
HCM LOS	A	A	A

Lane	NBLn1	EBLn1	WBLn1	SBLn1
Vol Left, %	44%	8%	5%	0%
Vol Thru, %	11%	87%	95%	14%
Vol Right, %	44%	6%	0%	86%
Sign Control	Stop	Stop	Stop	Stop
Traffic Vol by Lane	9	52	42	7
LT Vol	4	4	2	0
Through Vol	1	45	40	1
RT Vol	4	3	0	6
Lane Flow Rate	11	63	51	8
Geometry Grp	1	1	1	1
Degree of Util (X)	0.012	0.069	0.056	0.008
Departure Headway (Hd)	3.924	3.952	3.99	3.59
Convergence, Y/N	Yes	Yes	Yes	Yes
Cap	907	908	899	990
Service Time	1.971	1.967	2.007	1.638
HCM Lane V/C Ratio	0.012	0.069	0.057	0.008
HCM Control Delay	7	7.3	7.2	6.7
HCM Lane LOS	A	A	A	A
HCM 95th-tile Q	0	0.2	0.2	0

Intersection

Intersection Delay, s/veh

Intersection LOS

Movement	SBU	SBL	SBT	SBR
Lane Configurations			↕	
Traffic Vol, veh/h	0	0	1	6
Future Vol, veh/h	0	0	1	6
Peak Hour Factor	0.92	0.83	0.83	0.83
Heavy Vehicles, %	2	0	0	0
Mvmt Flow	0	0	1	7
Number of Lanes	0	0	1	0

Approach SB

Opposing Approach	NB
Opposing Lanes	1
Conflicting Approach Left	WB
Conflicting Lanes Left	1
Conflicting Approach Right	EB
Conflicting Lanes Right	1
HCM Control Delay	6.7
HCM LOS	A

Intersection

Int Delay, s/veh 0.2

Movement	EBL	EBR	NBL	NBT	SBT	SBR
Lane Configurations	↘			↗	↗	
Traffic Vol, veh/h	3	8	4	732	945	5
Future Vol, veh/h	3	8	4	732	945	5
Conflicting Peds, #/hr	0	0	1	0	0	1
Sign Control	Stop	Stop	Free	Free	Free	Free
RT Channelized	-	None	-	None	-	None
Storage Length	0	-	-	-	-	-
Veh in Median Storage, #	0	-	-	0	0	-
Grade, %	0	-	-	0	0	-
Peak Hour Factor	95	95	95	95	95	95
Heavy Vehicles, %	2	2	2	2	2	2
Mvmt Flow	3	8	4	771	995	5

Major/Minor	Minor2		Major1		Major2	
Conflicting Flow All	1777	998	1001	0	-	0
Stage 1	998	-	-	-	-	-
Stage 2	779	-	-	-	-	-
Critical Hdwy	6.42	6.22	4.12	-	-	-
Critical Hdwy Stg 1	5.42	-	-	-	-	-
Critical Hdwy Stg 2	5.42	-	-	-	-	-
Follow-up Hdwy	3.518	3.318	2.218	-	-	-
Pot Cap-1 Maneuver	91	296	692	-	-	-
Stage 1	357	-	-	-	-	-
Stage 2	452	-	-	-	-	-
Platoon blocked, %				-	-	-
Mov Cap-1 Maneuver	90	296	692	-	-	-
Mov Cap-2 Maneuver	90	-	-	-	-	-
Stage 1	357	-	-	-	-	-
Stage 2	447	-	-	-	-	-

Approach	EB	NB	SB
HCM Control Delay, s	26.1	0.1	0
HCM LOS	D		

Minor Lane/Major Mvmt	NBL	NBT	EBLn1	SBT	SBR
Capacity (veh/h)	692	-	182	-	-
HCM Lane V/C Ratio	0.006	-	0.064	-	-
HCM Control Delay (s)	10.2	0	26.1	-	-
HCM Lane LOS	B	A	D	-	-
HCM 95th %tile Q(veh)	0	-	0.2	-	-

Appendix 6 Background Conditions Level- of-Service Worksheets

Intersection

Int Delay, s/veh 0.4

Movement	WBL	WBR	NBT	NBR	SBL	SBT
Lane Configurations	↘		↑	↗		↖
Traffic Vol, veh/h	14	7	696	15	1	584
Future Vol, veh/h	14	7	696	15	1	584
Conflicting Peds, #/hr	0	0	0	0	0	0
Sign Control	Stop	Stop	Free	Free	Free	Free
RT Channelized	-	None	-	None	-	None
Storage Length	0	-	-	125	-	-
Veh in Median Storage, #	0	-	0	-	-	0
Grade, %	0	-	0	-	-	0
Peak Hour Factor	92	92	92	92	92	92
Heavy Vehicles, %	0	0	6	0	0	4
Mvmt Flow	15	8	757	16	1	635

Major/Minor	Minor1		Major1		Major2	
Conflicting Flow All	1394	757	0	0	757	0
Stage 1	757	-	-	-	-	-
Stage 2	637	-	-	-	-	-
Critical Hdwy	6.4	6.2	-	-	4.1	-
Critical Hdwy Stg 1	5.4	-	-	-	-	-
Critical Hdwy Stg 2	5.4	-	-	-	-	-
Follow-up Hdwy	3.5	3.3	-	-	2.2	-
Pot Cap-1 Maneuver	158	411	-	-	863	-
Stage 1	467	-	-	-	-	-
Stage 2	531	-	-	-	-	-
Platoon blocked, %			-	-		
Mov Cap-1 Maneuver	158	411	-	-	863	-
Mov Cap-2 Maneuver	158	-	-	-	-	-
Stage 1	467	-	-	-	-	-
Stage 2	530	-	-	-	-	-

Approach	WB		NB		SB
HCM Control Delay, s	25.4		0		0
HCM LOS	D				

Minor Lane/Major Mvmt	NBT	NBRWBLn1	SBL	SBT
Capacity (veh/h)	-	- 199	863	-
HCM Lane V/C Ratio	-	- 0.115	0.001	-
HCM Control Delay (s)	-	- 25.4	9.2	0
HCM Lane LOS	-	- D	A	A
HCM 95th %tile Q(veh)	-	- 0.4	0	-

Intersection

Int Delay, s/veh 0.1

Movement	EBL	EBT	EBR	WBL	WBT	WBR	NBL	NBT	NBR	SBL	SBT	SBR
Lane Configurations		↔			↔		↑	↑		↑	↑	
Traffic Vol, veh/h	4	0	1	0	0	0	0	701	0	0	610	4
Future Vol, veh/h	4	0	1	0	0	0	0	701	0	0	610	4
Conflicting Peds, #/hr	1	0	0	0	0	1	1	0	1	1	0	1
Sign Control	Stop	Stop	Stop	Stop	Stop	Stop	Free	Free	Free	Free	Free	Free
RT Channelized	-	-	None	-	-	None	-	-	None	-	-	None
Storage Length	-	-	-	-	-	-	65	-	-	50	-	-
Veh in Median Storage, #	-	0	-	-	0	-	-	0	-	-	0	-
Grade, %	-	0	-	-	0	-	-	0	-	-	0	-
Peak Hour Factor	93	93	93	93	93	93	93	93	93	93	93	93
Heavy Vehicles, %	0	0	0	0	0	0	0	6	0	0	4	0
Mvmt Flow	4	0	1	0	0	0	0	754	0	0	656	4

Major/Minor	Minor2			Minor1			Major1			Major2		
Conflicting Flow All	1414	1414	659	1414	1416	756	661	0	0	755	0	0
Stage 1	659	659	-	755	755	-	-	-	-	-	-	-
Stage 2	755	755	-	659	661	-	-	-	-	-	-	-
Critical Hdwy	7.1	6.5	6.2	7.1	6.5	6.2	4.1	-	-	4.1	-	-
Critical Hdwy Stg 1	6.1	5.5	-	6.1	5.5	-	-	-	-	-	-	-
Critical Hdwy Stg 2	6.1	5.5	-	6.1	5.5	-	-	-	-	-	-	-
Follow-up Hdwy	3.5	4	3.3	3.5	4	3.3	2.2	-	-	2.2	-	-
Pot Cap-1 Maneuver	116	139	467	116	139	411	937	-	-	865	-	-
Stage 1	456	464	-	404	420	-	-	-	-	-	-	-
Stage 2	404	420	-	456	463	-	-	-	-	-	-	-
Platoon blocked, %												
Mov Cap-1 Maneuver	116	139	467	116	139	410	937	-	-	864	-	-
Mov Cap-2 Maneuver	116	139	-	116	139	-	-	-	-	-	-	-
Stage 1	456	464	-	404	420	-	-	-	-	-	-	-
Stage 2	404	420	-	455	463	-	-	-	-	-	-	-

Approach	EB	WB	NB	SB
HCM Control Delay, s	32.3	0	0	0
HCM LOS	D	A		

Minor Lane/Major Mvmt	NBL	NBT	NBR	EBLn1WBLn1	SBL	SBT	SBR
Capacity (veh/h)	937	-	-	137	-	864	-
HCM Lane V/C Ratio	-	-	-	0.039	-	-	-
HCM Control Delay (s)	0	-	-	32.3	0	0	-
HCM Lane LOS	A	-	-	D	A	A	-
HCM 95th %tile Q(veh)	0	-	-	0.1	-	0	-

Intersection

Int Delay, s/veh 0.3

Movement	WBL	WBR	NBT	NBR	SBL	SBT
Lane Configurations	Y		P		T	T
Traffic Vol, veh/h	0	23	675	0	5	599
Future Vol, veh/h	0	23	675	0	5	599
Conflicting Peds, #/hr	0	0	0	0	0	0
Sign Control	Stop	Stop	Free	Free	Free	Free
RT Channelized	-	None	-	None	-	None
Storage Length	0	-	-	-	65	-
Veh in Median Storage, #	0	-	0	-	-	0
Grade, %	0	-	0	-	-	0
Peak Hour Factor	92	92	92	92	92	92
Heavy Vehicles, %	0	0	6	0	0	4
Mvmt Flow	0	25	734	0	5	651

Major/Minor	Minor1		Major1		Major2	
Conflicting Flow All	1396	734	0	0	734	0
Stage 1	734	-	-	-	-	-
Stage 2	662	-	-	-	-	-
Critical Hdwy	6.4	6.2	-	-	4.1	-
Critical Hdwy Stg 1	5.4	-	-	-	-	-
Critical Hdwy Stg 2	5.4	-	-	-	-	-
Follow-up Hdwy	3.5	3.3	-	-	2.2	-
Pot Cap-1 Maneuver	157	423	-	-	880	-
Stage 1	478	-	-	-	-	-
Stage 2	517	-	-	-	-	-
Platoon blocked, %			-	-		
Mov Cap-1 Maneuver	156	423	-	-	880	-
Mov Cap-2 Maneuver	156	-	-	-	-	-
Stage 1	478	-	-	-	-	-
Stage 2	514	-	-	-	-	-

Approach	WB		NB		SB
HCM Control Delay, s	14		0		0.1
HCM LOS	B				

Minor Lane/Major Mvmt	NBT	NBRWBLn1	SBL	SBT
Capacity (veh/h)	-	- 423	880	-
HCM Lane V/C Ratio	-	- 0.059	0.006	-
HCM Control Delay (s)	-	- 14	9.1	-
HCM Lane LOS	-	- B	A	-
HCM 95th %tile Q(veh)	-	- 0.2	0	-

Intersection

Int Delay, s/veh 7.6

Movement	WBL	WBR	NBT	NBR	SBL	SBT
Lane Configurations	Y		P			A
Traffic Vol, veh/h	1	22	1	0	5	1
Future Vol, veh/h	1	22	1	0	5	1
Conflicting Peds, #/hr	0	0	0	0	0	0
Sign Control	Stop	Stop	Free	Free	Free	Free
RT Channelized	-	None	-	None	-	None
Storage Length	0	-	-	-	-	-
Veh in Median Storage, #	0	-	0	-	-	0
Grade, %	0	-	0	-	-	0
Peak Hour Factor	75	75	75	75	75	75
Heavy Vehicles, %	0	0	0	0	0	0
Mvmt Flow	1	29	1	0	7	1

Major/Minor	Minor1		Major1		Major2	
Conflicting Flow All	16	1	0	0	1	0
Stage 1	1	-	-	-	-	-
Stage 2	15	-	-	-	-	-
Critical Hdwy	6.4	6.2	-	-	4.1	-
Critical Hdwy Stg 1	5.4	-	-	-	-	-
Critical Hdwy Stg 2	5.4	-	-	-	-	-
Follow-up Hdwy	3.5	3.3	-	-	2.2	-
Pot Cap-1 Maneuver	1008	1090	-	-	1635	-
Stage 1	1028	-	-	-	-	-
Stage 2	1013	-	-	-	-	-
Platoon blocked, %			-	-		-
Mov Cap-1 Maneuver	1004	1090	-	-	1635	-
Mov Cap-2 Maneuver	1004	-	-	-	-	-
Stage 1	1028	-	-	-	-	-
Stage 2	1009	-	-	-	-	-

Approach	WB		NB		SB
HCM Control Delay, s	8.4		0		6
HCM LOS	A				

Minor Lane/Major Mvmt	NBT	NBRWBLn1	SBL	SBT
Capacity (veh/h)	-	- 1086	1635	-
HCM Lane V/C Ratio	-	- 0.028	0.004	-
HCM Control Delay (s)	-	- 8.4	7.2	0
HCM Lane LOS	-	- A	A	A
HCM 95th %tile Q(veh)	-	- 0.1	0	-

Intersection

Int Delay, s/veh 5.7

Movement	EBT	EBR	WBL	WBT	NBL	NBR
Lane Configurations	↔		↔		↔	
Traffic Vol, veh/h	2	3	0	4	18	0
Future Vol, veh/h	2	3	0	4	18	0
Conflicting Peds, #/hr	0	0	0	0	0	1
Sign Control	Free	Free	Free	Free	Stop	Stop
RT Channelized	-	None	-	None	-	None
Storage Length	-	-	-	-	0	-
Veh in Median Storage, #	0	-	-	0	0	-
Grade, %	0	-	-	0	0	-
Peak Hour Factor	70	70	70	70	70	70
Heavy Vehicles, %	0	0	0	0	0	0
Mvmt Flow	3	4	0	6	26	0

Major/Minor	Major1	Major2	Minor1
Conflicting Flow All	0	0	7
Stage 1	-	-	-
Stage 2	-	-	-
Critical Hdwy	-	-	4.1
Critical Hdwy Stg 1	-	-	-
Critical Hdwy Stg 2	-	-	-
Follow-up Hdwy	-	-	2.2
Pot Cap-1 Maneuver	-	-	1627
Stage 1	-	-	-
Stage 2	-	-	-
Platoon blocked, %	-	-	-
Mov Cap-1 Maneuver	-	-	1625
Mov Cap-2 Maneuver	-	-	-
Stage 1	-	-	-
Stage 2	-	-	-

Approach	EB	WB	NB
HCM Control Delay, s	0	0	8.6
HCM LOS			A

Minor Lane/Major Mvmt	NBLn1	EBT	EBR	WBL	WBT
Capacity (veh/h)	1014	-	-	1625	-
HCM Lane V/C Ratio	0.025	-	-	-	-
HCM Control Delay (s)	8.6	-	-	0	-
HCM Lane LOS	A	-	-	A	-
HCM 95th %tile Q(veh)	0.1	-	-	0	-

Intersection												
Int Delay, s/veh	0.6											
Movement	EBL	EBT	EBR	WBL	WBT	WBR	NBL	NBT	NBR	SBL	SBT	SBR
Lane Configurations		↔			↔		↕	↕		↕	↕	
Traffic Vol, veh/h	3	0	5	2	0	26	4	648	4	10	582	0
Future Vol, veh/h	3	0	5	2	0	26	4	648	4	10	582	0
Conflicting Peds, #/hr	0	0	0	0	0	0	1	0	0	0	0	1
Sign Control	Stop	Stop	Stop	Stop	Stop	Stop	Free	Free	Free	Free	Free	Free
RT Channelized	-	-	None	-	-	None	-	-	None	-	-	None
Storage Length	-	-	-	-	-	-	125	-	-	125	-	-
Veh in Median Storage, #	-	0	-	-	0	-	-	0	-	-	0	-
Grade, %	-	0	-	-	0	-	-	0	-	-	0	-
Peak Hour Factor	90	90	90	90	90	90	90	90	90	90	90	90
Heavy Vehicles, %	0	0	0	0	0	4	0	6	0	0	4	0
Mvmt Flow	3	0	6	2	0	29	4	720	4	11	647	0

Major/Minor	Minor2			Minor1			Major1			Major2		
Conflicting Flow All	1416	1403	648	1403	1401	722	648	0	0	724	0	0
Stage 1	670	670	-	731	731	-	-	-	-	-	-	-
Stage 2	746	733	-	672	670	-	-	-	-	-	-	-
Critical Hdwy	7.1	6.5	6.2	7.1	6.5	6.24	4.1	-	-	4.1	-	-
Critical Hdwy Stg 1	6.1	5.5	-	6.1	5.5	-	-	-	-	-	-	-
Critical Hdwy Stg 2	6.1	5.5	-	6.1	5.5	-	-	-	-	-	-	-
Follow-up Hdwy	3.5	4	3.3	3.5	4	3.336	2.2	-	-	2.2	-	-
Pot Cap-1 Maneuver	116	141	474	118	141	423	947	-	-	888	-	-
Stage 1	450	459	-	416	430	-	-	-	-	-	-	-
Stage 2	409	429	-	449	459	-	-	-	-	-	-	-
Platoon blocked, %												
Mov Cap-1 Maneuver	107	139	474	115	139	423	947	-	-	888	-	-
Mov Cap-2 Maneuver	107	139	-	115	139	-	-	-	-	-	-	-
Stage 1	448	453	-	414	428	-	-	-	-	-	-	-
Stage 2	379	427	-	438	453	-	-	-	-	-	-	-

Approach	EB	WB	NB	SB
HCM Control Delay, s	23.2	16.1	0.1	0.2
HCM LOS	C	C		

Minor Lane/Major Mvmt	NBL	NBT	NBR	EBLn1WBLn1	SBL	SBT	SBR
Capacity (veh/h)	947	-	-	207	355	888	-
HCM Lane V/C Ratio	0.005	-	-	0.043	0.088	0.013	-
HCM Control Delay (s)	8.8	-	-	23.2	16.1	9.1	-
HCM Lane LOS	A	-	-	C	C	A	-
HCM 95th %tile Q(veh)	0	-	-	0.1	0.3	0	-

Intersection

Int Delay, s/veh 2.7

Movement	EBL	EBT	EBR	WBL	WBT	WBR	NBL	NBT	NBR	SBL	SBT	SBR
Lane Configurations		↔			↔		↔	↔		↔	↔	
Traffic Vol, veh/h	10	0	11	48	0	15	4	636	21	6	578	6
Future Vol, veh/h	10	0	11	48	0	15	4	636	21	6	578	6
Conflicting Peds, #/hr	0	0	0	0	0	0	1	0	0	0	0	1
Sign Control	Stop	Stop	Stop	Stop	Stop	Stop	Free	Free	Free	Free	Free	Free
RT Channelized	-	-	None	-	-	None	-	-	None	-	-	None
Storage Length	-	-	-	-	-	-	80	-	-	125	-	-
Veh in Median Storage, #	-	0	-	-	0	-	-	0	-	-	0	-
Grade, %	-	0	-	-	0	-	-	0	-	-	0	-
Peak Hour Factor	93	93	93	93	93	93	93	93	93	93	93	93
Heavy Vehicles, %	2	2	2	2	2	2	2	2	2	2	2	2
Mvmt Flow	11	0	12	52	0	16	4	684	23	6	622	6

Major/Minor	Minor2			Minor1			Major1			Major2		
Conflicting Flow All	1351	1354	626	1348	1346	695	629	0	0	706	0	0
Stage 1	639	639	-	704	704	-	-	-	-	-	-	-
Stage 2	712	715	-	644	642	-	-	-	-	-	-	-
Critical Hdwy	7.12	6.52	6.22	7.12	6.52	6.22	4.12	-	-	4.12	-	-
Critical Hdwy Stg 1	6.12	5.52	-	6.12	5.52	-	-	-	-	-	-	-
Critical Hdwy Stg 2	6.12	5.52	-	6.12	5.52	-	-	-	-	-	-	-
Follow-up Hdwy	3.518	4.018	3.318	3.518	4.018	3.318	2.218	-	-	2.218	-	-
Pot Cap-1 Maneuver	127	150	484	128	151	442	953	-	-	892	-	-
Stage 1	464	470	-	428	440	-	-	-	-	-	-	-
Stage 2	423	434	-	461	469	-	-	-	-	-	-	-
Platoon blocked, %												
Mov Cap-1 Maneuver	121	148	484	124	149	442	953	-	-	892	-	-
Mov Cap-2 Maneuver	121	148	-	124	149	-	-	-	-	-	-	-
Stage 1	462	466	-	426	438	-	-	-	-	-	-	-
Stage 2	406	432	-	447	465	-	-	-	-	-	-	-

Approach	EB	WB	NB	SB
HCM Control Delay, s	25.4	47.4	0.1	0.1
HCM LOS	D	E		

Minor Lane/Major Mvmt	NBL	NBT	NBR	EBLn1	WBLn1	SBL	SBT	SBR
Capacity (veh/h)	953	-	-	199	150	892	-	-
HCM Lane V/C Ratio	0.005	-	-	0.113	0.452	0.007	-	-
HCM Control Delay (s)	8.8	-	-	25.4	47.4	9.1	-	-
HCM Lane LOS	A	-	-	D	E	A	-	-
HCM 95th %tile Q(veh)	0	-	-	0.4	2.1	0	-	-

Intersection

Int Delay, s/veh 1.6

Movement	EBL	EBT	EBR	WBL	WBT	WBR	NBL	NBT	NBR	SBL	SBT	SBR
Lane Configurations		↕			↕			↕			↕	
Traffic Vol, veh/h	6	16	0	1	65	0	3	2	0	2	2	3
Future Vol, veh/h	6	16	0	1	65	0	3	2	0	2	2	3
Conflicting Peds, #/hr	1	0	0	0	0	1	0	0	1	1	0	0
Sign Control	Free	Free	Free	Free	Free	Free	Stop	Stop	Stop	Stop	Stop	Stop
RT Channelized	-	-	None	-	-	None	-	-	None	-	-	None
Storage Length	-	-	-	-	-	-	-	-	-	-	-	-
Veh in Median Storage, #	-	0	-	-	0	-	-	0	-	-	0	-
Grade, %	-	0	-	-	0	-	-	0	-	-	0	-
Peak Hour Factor	74	74	74	74	74	74	74	74	74	74	74	74
Heavy Vehicles, %	0	0	0	0	0	0	33	0	0	0	0	0
Mvmt Flow	8	22	0	1	88	0	4	3	0	3	3	4

Major/Minor	Major1			Major2			Minor1			Minor2		
Conflicting Flow All	89	0	0	22	0	0	132	130	23	132	130	89
Stage 1	-	-	-	-	-	-	38	38	-	92	92	-
Stage 2	-	-	-	-	-	-	94	92	-	40	38	-
Critical Hdwy	4.1	-	-	4.1	-	-	7.43	6.5	6.2	7.1	6.5	6.2
Critical Hdwy Stg 1	-	-	-	-	-	-	6.43	5.5	-	6.1	5.5	-
Critical Hdwy Stg 2	-	-	-	-	-	-	6.43	5.5	-	6.1	5.5	-
Follow-up Hdwy	2.2	-	-	2.2	-	-	3.797	4	3.3	3.5	4	3.3
Pot Cap-1 Maneuver	1519	-	-	1607	-	-	773	764	1060	845	764	975
Stage 1	-	-	-	-	-	-	904	867	-	920	823	-
Stage 2	-	-	-	-	-	-	842	823	-	980	867	-
Platoon blocked, %	-	-	-	-	-	-	-	-	-	-	-	-
Mov Cap-1 Maneuver	1519	-	-	1605	-	-	764	759	1059	837	759	974
Mov Cap-2 Maneuver	-	-	-	-	-	-	764	759	-	837	759	-
Stage 1	-	-	-	-	-	-	899	863	-	915	821	-
Stage 2	-	-	-	-	-	-	835	821	-	971	863	-

Approach	EB	WB	NB	SB
HCM Control Delay, s	2	0.1	9.8	9.2
HCM LOS			A	A

Minor Lane/Major Mvmt	NBLn1	EBL	EBT	EBR	WBL	WBT	WBR	SBLn1
Capacity (veh/h)	762	1519	-	-	1605	-	-	864
HCM Lane V/C Ratio	0.009	0.005	-	-	0.001	-	-	0.011
HCM Control Delay (s)	9.8	7.4	0	-	7.2	0	-	9.2
HCM Lane LOS	A	A	A	-	A	A	-	A
HCM 95th %tile Q(veh)	0	0	-	-	0	-	-	0

Intersection

Int Delay, s/veh 7.7

Movement	EBL	EBT	EBR	WBL	WBT	WBR	NBL	NBT	NBR	SBL	SBT	SBR
Lane Configurations		↕			↕			↕			↕	
Traffic Vol, veh/h	0	14	0	1	65	9	2	17	0	1	4	0
Future Vol, veh/h	0	14	0	1	65	9	2	17	0	1	4	0
Conflicting Peds, #/hr	1	0	0	0	0	1	0	0	0	0	0	0
Sign Control	Stop	Stop	Stop	Stop	Stop	Stop	Free	Free	Free	Free	Free	Free
RT Channelized	-	-	None	-	-	None	-	-	None	-	-	None
Storage Length	-	-	-	-	-	-	-	-	-	-	-	-
Veh in Median Storage, #	-	0	-	-	0	-	-	0	-	-	0	-
Grade, %	-	0	-	-	0	-	-	0	-	-	0	-
Peak Hour Factor	83	83	83	83	83	83	83	83	83	83	83	83
Heavy Vehicles, %	0	0	0	0	0	0	0	6	0	0	0	0
Mvmt Flow	0	17	0	1	78	11	2	20	0	1	5	0

Major/Minor	Minor2			Minor1			Major1			Major2		
Conflicting Flow All	78	32	5	41	32	21	5	0	0	20	0	0
Stage 1	7	7	-	25	25	-	-	-	-	-	-	-
Stage 2	71	25	-	16	7	-	-	-	-	-	-	-
Critical Hdwy	7.1	6.5	6.2	7.1	6.5	6.2	4.1	-	-	4.1	-	-
Critical Hdwy Stg 1	6.1	5.5	-	6.1	5.5	-	-	-	-	-	-	-
Critical Hdwy Stg 2	6.1	5.5	-	6.1	5.5	-	-	-	-	-	-	-
Follow-up Hdwy	3.5	4	3.3	3.5	4	3.3	2.2	-	-	2.2	-	-
Pot Cap-1 Maneuver	916	865	1084	968	865	1062	1630	-	-	1609	-	-
Stage 1	1020	894	-	998	878	-	-	-	-	-	-	-
Stage 2	944	878	-	1009	894	-	-	-	-	-	-	-
Platoon blocked, %												
Mov Cap-1 Maneuver	842	863	1084	952	863	1061	1630	-	-	1607	-	-
Mov Cap-2 Maneuver	842	863	-	952	863	-	-	-	-	-	-	-
Stage 1	1019	893	-	997	877	-	-	-	-	-	-	-
Stage 2	849	877	-	989	893	-	-	-	-	-	-	-

Approach	EB	WB	NB	SB
HCM Control Delay, s	9.3	9.5	0.8	1.4
HCM LOS	A	A		

Minor Lane/Major Mvmt	NBL	NBT	NBR	EBLn1WBLn1	SBL	SBT	SBR
Capacity (veh/h)	1630	-	-	863	884	1607	-
HCM Lane V/C Ratio	0.001	-	-	0.02	0.102	0.001	-
HCM Control Delay (s)	7.2	0	-	9.3	9.5	7.2	0
HCM Lane LOS	A	A	-	A	A	A	A
HCM 95th %tile Q(veh)	0	-	-	0.1	0.3	0	-

Intersection	
Intersection Delay, s/veh	7.2
Intersection LOS	A

Movement	EBU	EBL	EBT	EBR	WBU	WBL	WBT	WBR	NBU	NBL	NBT	NBR
Lane Configurations			↕				↕				↕	
Traffic Vol, veh/h	0	0	17	1	0	5	63	1	0	1	1	2
Future Vol, veh/h	0	0	17	1	0	5	63	1	0	1	1	2
Peak Hour Factor	0.92	0.90	0.90	0.90	0.92	0.90	0.90	0.90	0.92	0.90	0.90	0.90
Heavy Vehicles, %	2	0	6	0	2	0	0	0	2	0	0	0
Mvmt Flow	0	0	19	1	0	6	70	1	0	1	1	2
Number of Lanes	0	0	1	0	0	0	1	0	0	0	1	0

Approach	EB	WB	NB
Opposing Approach	WB	EB	SB
Opposing Lanes	1	1	1
Conflicting Approach Left	SB	NB	EB
Conflicting Lanes Left	1	1	1
Conflicting Approach Right	NB	SB	WB
Conflicting Lanes Right	1	1	1
HCM Control Delay	7.2	7.3	6.9
HCM LOS	A	A	A

Lane	NBLn1	EBLn1	WBLn1	SBLn1
Vol Left, %	25%	0%	7%	0%
Vol Thru, %	25%	94%	91%	0%
Vol Right, %	50%	6%	1%	100%
Sign Control	Stop	Stop	Stop	Stop
Traffic Vol by Lane	4	18	69	6
LT Vol	1	0	5	0
Through Vol	1	17	63	0
RT Vol	2	1	1	6
Lane Flow Rate	4	20	77	7
Geometry Grp	1	1	1	1
Degree of Util (X)	0.005	0.022	0.084	0.006
Departure Headway (Hd)	3.823	4.045	3.94	3.47
Convergence, Y/N	Yes	Yes	Yes	Yes
Cap	932	887	913	1026
Service Time	1.861	2.061	1.946	1.51
HCM Lane V/C Ratio	0.004	0.023	0.084	0.007
HCM Control Delay	6.9	7.2	7.3	6.5
HCM Lane LOS	A	A	A	A
HCM 95th-tile Q	0	0.1	0.3	0

Intersection

Intersection Delay, s/veh

Intersection LOS

Movement	SBU	SBL	SBT	SBR
Lane Configurations			↕	
Traffic Vol, veh/h	0	0	0	6
Future Vol, veh/h	0	0	0	6
Peak Hour Factor	0.92	0.90	0.90	0.90
Heavy Vehicles, %	2	0	0	0
Mvmt Flow	0	0	0	7
Number of Lanes	0	0	1	0

Approach SB

Opposing Approach	NB
Opposing Lanes	1
Conflicting Approach Left	WB
Conflicting Lanes Left	1
Conflicting Approach Right	EB
Conflicting Lanes Right	1
HCM Control Delay	6.5
HCM LOS	A

Intersection

Int Delay, s/veh 0.2

Movement	EBL	EBR	NBL	NBT	SBT	SBR
Lane Configurations	Y			Y	Y	
Traffic Vol, veh/h	3	6	7	655	584	0
Future Vol, veh/h	3	6	7	655	584	0
Conflicting Peds, #/hr	0	0	1	0	0	1
Sign Control	Stop	Stop	Free	Free	Free	Free
RT Channelized	-	None	-	None	-	None
Storage Length	0	-	-	-	-	-
Veh in Median Storage, #	0	-	-	0	0	-
Grade, %	0	-	-	0	0	-
Peak Hour Factor	93	93	93	93	93	93
Heavy Vehicles, %	2	2	2	2	2	2
Mvmt Flow	3	6	8	704	628	0

Major/Minor	Minor2	Major1		Major2	
Conflicting Flow All	1348	629	629	0	0
Stage 1	629	-	-	-	-
Stage 2	719	-	-	-	-
Critical Hdwy	6.42	6.22	4.12	-	-
Critical Hdwy Stg 1	5.42	-	-	-	-
Critical Hdwy Stg 2	5.42	-	-	-	-
Follow-up Hdwy	3.518	3.318	2.218	-	-
Pot Cap-1 Maneuver	166	482	953	-	-
Stage 1	531	-	-	-	-
Stage 2	483	-	-	-	-
Platoon blocked, %				-	-
Mov Cap-1 Maneuver	163	482	953	-	-
Mov Cap-2 Maneuver	163	-	-	-	-
Stage 1	530	-	-	-	-
Stage 2	476	-	-	-	-

Approach	EB	NB	SB
HCM Control Delay, s	17.8	0.1	0
HCM LOS	C		

Minor Lane/Major Mvmt	NBL	NBT	EBLn1	SBT	SBR
Capacity (veh/h)	953	-	292	-	-
HCM Lane V/C Ratio	0.008	-	0.033	-	-
HCM Control Delay (s)	8.8	0	17.8	-	-
HCM Lane LOS	A	A	C	-	-
HCM 95th %tile Q(veh)	0	-	0.1	-	-

Intersection

Int Delay, s/veh 0.4

Movement	WBL	WBR	NBT	NBR	SBL	SBT
Lane Configurations	↘		↑	↗		↖
Traffic Vol, veh/h	11	5	732	18	5	923
Future Vol, veh/h	11	5	732	18	5	923
Conflicting Peds, #/hr	0	0	0	1	1	0
Sign Control	Stop	Stop	Free	Free	Free	Free
RT Channelized	-	None	-	None	-	None
Storage Length	0	-	-	125	-	-
Veh in Median Storage, #	0	-	0	-	-	0
Grade, %	0	-	0	-	-	0
Peak Hour Factor	95	95	95	95	95	95
Heavy Vehicles, %	0	0	2	0	0	2
Mvmt Flow	12	5	771	19	5	972

Major/Minor	Minor1		Major1		Major2	
Conflicting Flow All	1754	772	0	0	772	0
Stage 1	772	-	-	-	-	-
Stage 2	982	-	-	-	-	-
Critical Hdwy	6.4	6.2	-	-	4.1	-
Critical Hdwy Stg 1	5.4	-	-	-	-	-
Critical Hdwy Stg 2	5.4	-	-	-	-	-
Follow-up Hdwy	3.5	3.3	-	-	2.2	-
Pot Cap-1 Maneuver	95	403	-	-	852	-
Stage 1	459	-	-	-	-	-
Stage 2	366	-	-	-	-	-
Platoon blocked, %			-	-		
Mov Cap-1 Maneuver	94	403	-	-	852	-
Mov Cap-2 Maneuver	94	-	-	-	-	-
Stage 1	459	-	-	-	-	-
Stage 2	361	-	-	-	-	-

Approach	WB		NB		SB
HCM Control Delay, s	38.5		0		0
HCM LOS	E				

Minor Lane/Major Mvmt	NBT	NBRWBLn1	SBL	SBT
Capacity (veh/h)	-	- 124	852	-
HCM Lane V/C Ratio	-	- 0.136	0.006	-
HCM Control Delay (s)	-	- 38.5	9.3	0
HCM Lane LOS	-	- E	A	A
HCM 95th %tile Q(veh)	-	- 0.5	0	-

Intersection

Int Delay, s/veh 0.3

Movement	EBL	EBT	EBR	WBL	WBT	WBR	NBL	NBT	NBR	SBL	SBT	SBR
Lane Configurations		↔			↔		↑	↑		↑	↑	
Traffic Vol, veh/h	5	0	4	1	0	2	0	744	0	1	919	4
Future Vol, veh/h	5	0	4	1	0	2	0	744	0	1	919	4
Conflicting Peds, #/hr	5	0	0	0	0	5	0	0	4	4	0	0
Sign Control	Stop	Stop	Stop	Stop	Stop	Stop	Free	Free	Free	Free	Free	Free
RT Channelized	-	-	None	-	-	None	-	-	None	-	-	None
Storage Length	-	-	-	-	-	-	65	-	-	50	-	-
Veh in Median Storage, #	-	0	-	-	0	-	-	0	-	-	0	-
Grade, %	-	0	-	-	0	-	-	0	-	-	0	-
Peak Hour Factor	94	94	94	94	94	94	94	94	94	94	94	94
Heavy Vehicles, %	0	0	0	0	0	0	0	2	0	0	1	0
Mvmt Flow	5	0	4	1	0	2	0	791	0	1	978	4

Major/Minor	Minor2			Minor1			Major1			Major2		
Conflicting Flow All	1780	1777	980	1779	1779	800	982	0	0	795	0	0
Stage 1	982	982	-	795	795	-	-	-	-	-	-	-
Stage 2	798	795	-	984	984	-	-	-	-	-	-	-
Critical Hdwy	7.1	6.5	6.2	7.1	6.5	6.2	4.1	-	-	4.1	-	-
Critical Hdwy Stg 1	6.1	5.5	-	6.1	5.5	-	-	-	-	-	-	-
Critical Hdwy Stg 2	6.1	5.5	-	6.1	5.5	-	-	-	-	-	-	-
Follow-up Hdwy	3.5	4	3.3	3.5	4	3.3	2.2	-	-	2.2	-	-
Pot Cap-1 Maneuver	65	83	306	65	83	388	711	-	-	835	-	-
Stage 1	302	330	-	384	402	-	-	-	-	-	-	-
Stage 2	382	402	-	302	329	-	-	-	-	-	-	-
Platoon blocked, %												
Mov Cap-1 Maneuver	64	83	306	64	83	385	711	-	-	831	-	-
Mov Cap-2 Maneuver	64	83	-	64	83	-	-	-	-	-	-	-
Stage 1	302	330	-	383	400	-	-	-	-	-	-	-
Stage 2	378	400	-	297	329	-	-	-	-	-	-	-

Approach	EB	WB	NB	SB
HCM Control Delay, s	45.2	30.6	0	0
HCM LOS	E	D		

Minor Lane/Major Mvmt	NBL	NBT	NBR	EBLn1WBLn1	SBL	SBT	SBR
Capacity (veh/h)	711	-	-	99	144	831	-
HCM Lane V/C Ratio	-	-	-	0.097	0.022	0.001	-
HCM Control Delay (s)	0	-	-	45.2	30.6	9.3	-
HCM Lane LOS	A	-	-	E	D	A	-
HCM 95th %tile Q(veh)	0	-	-	0.3	0.1	0	-

Intersection

Int Delay, s/veh 0.2

Movement	WBL	WBR	NBT	NBR	SBL	SBT
Lane Configurations	Y		P		T	T
Traffic Vol, veh/h	0	5	739	0	18	912
Future Vol, veh/h	0	5	739	0	18	912
Conflicting Peds, #/hr	0	0	0	2	2	0
Sign Control	Stop	Stop	Free	Free	Free	Free
RT Channelized	-	None	-	None	-	None
Storage Length	0	-	-	-	65	-
Veh in Median Storage, #	0	-	0	-	-	0
Grade, %	0	-	0	-	-	0
Peak Hour Factor	96	96	96	96	96	96
Heavy Vehicles, %	0	0	2	0	0	2
Mvmt Flow	0	5	770	0	19	950

Major/Minor	Minor1		Major1		Major2	
Conflicting Flow All	1760	772	0	0	772	0
Stage 1	772	-	-	-	-	-
Stage 2	988	-	-	-	-	-
Critical Hdwy	6.4	6.2	-	-	4.1	-
Critical Hdwy Stg 1	5.4	-	-	-	-	-
Critical Hdwy Stg 2	5.4	-	-	-	-	-
Follow-up Hdwy	3.5	3.3	-	-	2.2	-
Pot Cap-1 Maneuver	94	403	-	-	852	-
Stage 1	459	-	-	-	-	-
Stage 2	364	-	-	-	-	-
Platoon blocked, %			-	-		-
Mov Cap-1 Maneuver	92	402	-	-	852	-
Mov Cap-2 Maneuver	92	-	-	-	-	-
Stage 1	458	-	-	-	-	-
Stage 2	356	-	-	-	-	-

Approach	WB		NB		SB
HCM Control Delay, s	14.1		0		0.2
HCM LOS	B				

Minor Lane/Major Mvmt	NBT	NBRWBLn1	SBL	SBT
Capacity (veh/h)	-	- 402	852	-
HCM Lane V/C Ratio	-	- 0.013	0.022	-
HCM Control Delay (s)	-	- 14.1	9.3	-
HCM Lane LOS	-	- B	A	-
HCM 95th %tile Q(veh)	-	- 0	0.1	-

Intersection

Int Delay, s/veh 6.3

Movement	WBL	WBR	NBT	NBR	SBL	SBT
Lane Configurations	Y		P			A
Traffic Vol, veh/h	4	6	1	6	19	0
Future Vol, veh/h	4	6	1	6	19	0
Conflicting Peds, #/hr	1	0	0	5	5	0
Sign Control	Stop	Stop	Free	Free	Free	Free
RT Channelized	-	None	-	None	-	None
Storage Length	0	-	-	-	-	-
Veh in Median Storage, #	0	-	0	-	-	0
Grade, %	0	-	0	-	-	0
Peak Hour Factor	75	75	75	75	75	75
Heavy Vehicles, %	0	17	0	0	0	0
Mvmt Flow	5	8	1	8	25	0

Major/Minor	Minor1		Major1		Major2	
Conflicting Flow All	62	10	0	0	14	0
Stage 1	10	-	-	-	-	-
Stage 2	52	-	-	-	-	-
Critical Hdwy	6.4	6.37	-	-	4.1	-
Critical Hdwy Stg 1	5.4	-	-	-	-	-
Critical Hdwy Stg 2	5.4	-	-	-	-	-
Follow-up Hdwy	3.5	3.453	-	-	2.2	-
Pot Cap-1 Maneuver	949	1029	-	-	1617	-
Stage 1	1018	-	-	-	-	-
Stage 2	976	-	-	-	-	-
Platoon blocked, %			-	-		-
Mov Cap-1 Maneuver	929	1024	-	-	1617	-
Mov Cap-2 Maneuver	929	-	-	-	-	-
Stage 1	1013	-	-	-	-	-
Stage 2	960	-	-	-	-	-

Approach	WB		NB		SB
HCM Control Delay, s	8.7		0		7.3
HCM LOS	A				

Minor Lane/Major Mvmt	NBT	NBRWBLn1	SBL	SBT
Capacity (veh/h)	-	- 984	1617	-
HCM Lane V/C Ratio	-	- 0.014	0.016	-
HCM Control Delay (s)	-	- 8.7	7.3	0
HCM Lane LOS	-	- A	A	A
HCM 95th %tile Q(veh)	-	- 0	0	-

Intersection

Int Delay, s/veh 2

Movement	EBT	EBR	WBL	WBT	NBL	NBR
Lane Configurations	↔		↔		↔	
Traffic Vol, veh/h	8	16	1	4	7	0
Future Vol, veh/h	8	16	1	4	7	0
Conflicting Peds, #/hr	0	3	3	0	1	0
Sign Control	Free	Free	Free	Free	Stop	Stop
RT Channelized	-	None	-	None	-	None
Storage Length	-	-	-	-	0	-
Veh in Median Storage, #	0	-	-	0	0	-
Grade, %	0	-	-	0	0	-
Peak Hour Factor	69	69	69	69	69	69
Heavy Vehicles, %	0	0	0	0	29	0
Mvmt Flow	12	23	1	6	10	0

Major/Minor	Major1	Major2	Minor1
Conflicting Flow All	0	38	36
Stage 1	-	-	26
Stage 2	-	-	10
Critical Hdwy	-	4.1	7.39
Critical Hdwy Stg 1	-	-	6.39
Critical Hdwy Stg 2	-	-	6.39
Follow-up Hdwy	-	2.2	3.761
Pot Cap-1 Maneuver	-	1585	906
Stage 1	-	-	926
Stage 2	-	-	945
Platoon blocked, %	-	-	-
Mov Cap-1 Maneuver	-	1585	902
Mov Cap-2 Maneuver	-	-	902
Stage 1	-	-	926
Stage 2	-	-	943

Approach	EB	WB	NB
HCM Control Delay, s	0	1.5	9
HCM LOS			A

Minor Lane/Major Mvmt	NBLn1	EBT	EBR	WBL	WBT
Capacity (veh/h)	902	-	-	1585	-
HCM Lane V/C Ratio	0.011	-	-	0.001	-
HCM Control Delay (s)	9	-	-	7.3	0
HCM Lane LOS	A	-	-	A	A
HCM 95th %tile Q(veh)	0	-	-	0	-

Intersection

Int Delay, s/veh 1

Movement	EBL	EBT	EBR	WBL	WBT	WBR	NBL	NBT	NBR	SBL	SBT	SBR
Lane Configurations		↔			↔		↑	↑		↑	↑	
Traffic Vol, veh/h	7	0	7	7	0	17	10	716	7	28	873	5
Future Vol, veh/h	7	0	7	7	0	17	10	716	7	28	873	5
Conflicting Peds, #/hr	0	0	0	0	0	0	0	0	2	2	0	0
Sign Control	Stop	Stop	Stop	Stop	Stop	Stop	Free	Free	Free	Free	Free	Free
RT Channelized	-	-	None	-	-	None	-	-	None	-	-	None
Storage Length	-	-	-	-	-	-	125	-	-	125	-	-
Veh in Median Storage, #	-	0	-	-	0	-	-	0	-	-	0	-
Grade, %	-	0	-	-	0	-	-	0	-	-	0	-
Peak Hour Factor	96	96	96	96	96	96	96	96	96	96	96	96
Heavy Vehicles, %	0	0	0	0	0	0	0	2	14	7	2	0
Mvmt Flow	7	0	7	7	0	18	10	746	7	29	909	5

Major/Minor	Minor2			Minor1			Major1			Major2		
Conflicting Flow All	1749	1746	912	1746	1745	751	915	0	0	755	0	0
Stage 1	970	970	-	772	772	-	-	-	-	-	-	-
Stage 2	779	776	-	974	973	-	-	-	-	-	-	-
Critical Hdwy	7.1	6.5	6.2	7.1	6.5	6.2	4.1	-	-	4.17	-	-
Critical Hdwy Stg 1	6.1	5.5	-	6.1	5.5	-	-	-	-	-	-	-
Critical Hdwy Stg 2	6.1	5.5	-	6.1	5.5	-	-	-	-	-	-	-
Follow-up Hdwy	3.5	4	3.3	3.5	4	3.3	2.2	-	-	2.263	-	-
Pot Cap-1 Maneuver	68	87	335	68	87	414	754	-	-	833	-	-
Stage 1	307	334	-	395	412	-	-	-	-	-	-	-
Stage 2	392	410	-	305	333	-	-	-	-	-	-	-
Platoon blocked, %												
Mov Cap-1 Maneuver	63	83	335	64	83	413	754	-	-	833	-	-
Mov Cap-2 Maneuver	63	83	-	64	83	-	-	-	-	-	-	-
Stage 1	303	322	-	389	406	-	-	-	-	-	-	-
Stage 2	370	404	-	288	321	-	-	-	-	-	-	-

Approach	EB	WB	NB	SB
HCM Control Delay, s	44.3	31.8	0.1	0.3
HCM LOS	E	D		

Minor Lane/Major Mvmt	NBL	NBT	NBR	EBLn1	WBLn1	SBL	SBT	SBR
Capacity (veh/h)	754	-	-	106	159	833	-	-
HCM Lane V/C Ratio	0.014	-	-	0.138	0.157	0.035	-	-
HCM Control Delay (s)	9.8	-	-	44.3	31.8	9.5	-	-
HCM Lane LOS	A	-	-	E	D	A	-	-
HCM 95th %tile Q(veh)	0	-	-	0.5	0.5	0.1	-	-

Intersection

Int Delay, s/veh 3.3

Movement	EBL	EBT	EBR	WBL	WBT	WBR	NBL	NBT	NBR	SBL	SBT	SBR
Lane Configurations		↔			↔		↔	↔		↔	↔	
Traffic Vol, veh/h	3	0	3	32	0	13	5	721	42	17	867	10
Future Vol, veh/h	3	0	3	32	0	13	5	721	42	17	867	10
Conflicting Peds, #/hr	1	0	0	0	0	1	1	0	0	0	0	1
Sign Control	Stop	Stop	Stop	Stop	Stop	Stop	Free	Free	Free	Free	Free	Free
RT Channelized	-	-	None	-	-	None	-	-	None	-	-	None
Storage Length	-	-	-	-	-	-	80	-	-	125	-	-
Veh in Median Storage, #	-	0	-	-	0	-	-	0	-	-	0	-
Grade, %	-	0	-	-	0	-	-	0	-	-	0	-
Peak Hour Factor	91	91	91	91	91	91	91	91	91	91	91	91
Heavy Vehicles, %	2	2	2	2	2	2	2	2	2	2	2	2
Mvmt Flow	3	0	3	35	0	14	5	792	46	19	953	11

Major/Minor	Minor2			Minor1			Major1			Major2		
Conflicting Flow All	1832	1846	959	1823	1828	816	965	0	0	838	0	0
Stage 1	997	997	-	826	826	-	-	-	-	-	-	-
Stage 2	835	849	-	997	1002	-	-	-	-	-	-	-
Critical Hdwy	7.12	6.52	6.22	7.12	6.52	6.22	4.12	-	-	4.12	-	-
Critical Hdwy Stg 1	6.12	5.52	-	6.12	5.52	-	-	-	-	-	-	-
Critical Hdwy Stg 2	6.12	5.52	-	6.12	5.52	-	-	-	-	-	-	-
Follow-up Hdwy	3.518	4.018	3.318	3.518	4.018	3.318	2.218	-	-	2.218	-	-
Pot Cap-1 Maneuver	59	75	312	60	77	377	714	-	-	796	-	-
Stage 1	294	322	-	366	387	-	-	-	-	-	-	-
Stage 2	362	377	-	294	320	-	-	-	-	-	-	-
Platoon blocked, %												
Mov Cap-1 Maneuver	55	73	312	58	75	377	714	-	-	795	-	-
Mov Cap-2 Maneuver	55	73	-	58	75	-	-	-	-	-	-	-
Stage 1	292	314	-	363	384	-	-	-	-	-	-	-
Stage 2	346	374	-	284	312	-	-	-	-	-	-	-

Approach	EB	WB	NB	SB
HCM Control Delay, s	46.2	112.6	0.1	0.2
HCM LOS	E	F		

Minor Lane/Major Mvmt	NBL	NBT	NBR	EBLn1	WBLn1	SBL	SBT	SBR
Capacity (veh/h)	714	-	-	94	77	795	-	-
HCM Lane V/C Ratio	0.008	-	-	0.07	0.642	0.023	-	-
HCM Control Delay (s)	10.1	-	-	46.2	112.6	9.6	-	-
HCM Lane LOS	B	-	-	E	F	A	-	-
HCM 95th %tile Q(veh)	0	-	-	0.2	2.9	0.1	-	-

Intersection

Int Delay, s/veh 3.9

Movement	EBL	EBT	EBR	WBL	WBT	WBR	NBL	NBT	NBR	SBL	SBT	SBR
Lane Configurations		↕			↕			↕			↕	
Traffic Vol, veh/h	13	35	2	0	34	4	9	7	6	3	8	12
Future Vol, veh/h	13	35	2	0	34	4	9	7	6	3	8	12
Conflicting Peds, #/hr	2	0	1	1	0	2	0	0	0	0	0	0
Sign Control	Free	Free	Free	Free	Free	Free	Stop	Stop	Stop	Stop	Stop	Stop
RT Channelized	-	-	None	-	-	None	-	-	None	-	-	None
Storage Length	-	-	-	-	-	-	-	-	-	-	-	-
Veh in Median Storage, #	-	0	-	-	0	-	-	0	-	-	0	-
Grade, %	-	0	-	-	0	-	-	0	-	-	0	-
Peak Hour Factor	79	79	79	79	79	79	79	79	79	79	79	79
Heavy Vehicles, %	0	3	0	0	0	0	0	0	0	33	0	0
Mvmt Flow	16	44	3	0	43	5	11	9	8	4	10	15

Major/Minor	Major1			Major2			Minor1			Minor2		
Conflicting Flow All	50	0	0	48	0	0	137	129	47	135	129	48
Stage 1	-	-	-	-	-	-	79	79	-	48	48	-
Stage 2	-	-	-	-	-	-	58	50	-	87	81	-
Critical Hdwy	4.1	-	-	4.1	-	-	7.1	6.5	6.2	7.43	6.5	6.2
Critical Hdwy Stg 1	-	-	-	-	-	-	6.1	5.5	-	6.43	5.5	-
Critical Hdwy Stg 2	-	-	-	-	-	-	6.1	5.5	-	6.43	5.5	-
Follow-up Hdwy	2.2	-	-	2.2	-	-	3.5	4	3.3	3.797	4	3.3
Pot Cap-1 Maneuver	1570	-	-	1572	-	-	838	765	1028	770	765	1027
Stage 1	-	-	-	-	-	-	935	833	-	892	859	-
Stage 2	-	-	-	-	-	-	959	857	-	849	832	-
Platoon blocked, %	-	-	-	-	-	-	-	-	-	-	-	-
Mov Cap-1 Maneuver	1570	-	-	1572	-	-	810	755	1027	750	755	1025
Mov Cap-2 Maneuver	-	-	-	-	-	-	810	755	-	750	755	-
Stage 1	-	-	-	-	-	-	925	824	-	881	857	-
Stage 2	-	-	-	-	-	-	934	855	-	825	823	-

Approach	EB	WB	NB	SB
HCM Control Delay, s	1.9	0	9.4	9.3
HCM LOS			A	A

Minor Lane/Major Mvmt	NBLn1	EBL	EBT	EBR	WBL	WBT	WBR	SBLn1
Capacity (veh/h)	839	1570	-	-	1572	-	-	874
HCM Lane V/C Ratio	0.033	0.01	-	-	-	-	-	0.033
HCM Control Delay (s)	9.4	7.3	0	-	0	-	-	9.3
HCM Lane LOS	A	A	A	-	A	-	-	A
HCM 95th %tile Q(veh)	0.1	0	-	-	0	-	-	0.1

Intersection												
Int Delay, s/veh	7.5											
Movement	EBL	EBT	EBR	WBL	WBT	WBR	NBL	NBT	NBR	SBL	SBT	SBR
Lane Configurations		↕			↕			↕			↕	
Traffic Vol, veh/h	0	39	3	9	33	2	4	6	5	15	12	2
Future Vol, veh/h	0	39	3	9	33	2	4	6	5	15	12	2
Conflicting Peds, #/hr	3	0	0	0	0	3	3	0	2	2	0	3
Sign Control	Stop	Stop	Stop	Stop	Stop	Stop	Free	Free	Free	Free	Free	Free
RT Channelized	-	-	None	-	-	None	-	-	None	-	-	None
Storage Length	-	-	-	-	-	-	-	-	-	-	-	-
Veh in Median Storage, #	-	0	-	-	0	-	-	0	-	-	0	-
Grade, %	-	0	-	-	0	-	-	0	-	-	0	-
Peak Hour Factor	86	86	86	86	86	86	86	86	86	86	86	86
Heavy Vehicles, %	0	5	0	22	0	0	0	0	0	0	8	0
Mvmt Flow	0	45	3	10	38	2	5	7	6	17	14	2
Major/Minor	Minor2			Minor1			Major1			Major2		
Conflicting Flow All	96	77	18	95	75	15	19	0	0	15	0	0
Stage 1	53	53	-	21	21	-	-	-	-	-	-	-
Stage 2	43	24	-	74	54	-	-	-	-	-	-	-
Critical Hdwy	7.1	6.55	6.2	7.32	6.5	6.2	4.1	-	-	4.1	-	-
Critical Hdwy Stg 1	6.1	5.55	-	6.32	5.5	-	-	-	-	-	-	-
Critical Hdwy Stg 2	6.1	5.55	-	6.32	5.5	-	-	-	-	-	-	-
Follow-up Hdwy	3.5	4.045	3.3	3.698	4	3.3	2.2	-	-	2.2	-	-
Pot Cap-1 Maneuver	891	808	1066	842	819	1070	1611	-	-	1616	-	-
Stage 1	965	845	-	948	882	-	-	-	-	-	-	-
Stage 2	976	869	-	888	854	-	-	-	-	-	-	-
Platoon blocked, %												
Mov Cap-1 Maneuver	843	793	1063	793	804	1065	1611	-	-	1611	-	-
Mov Cap-2 Maneuver	843	793	-	793	804	-	-	-	-	-	-	-
Stage 1	959	833	-	943	878	-	-	-	-	-	-	-
Stage 2	926	865	-	828	842	-	-	-	-	-	-	-
Approach	EB			WB			NB			SB		
HCM Control Delay, s	9.7			9.7			1.9			3.8		
HCM LOS	A			A								
Minor Lane/Major Mvmt	NBL	NBT	NBR	EBLn1	WBLn1	SBL	SBT	SBR				
Capacity (veh/h)	1611	-	-	808	811	1611	-	-				
HCM Lane V/C Ratio	0.003	-	-	0.06	0.063	0.011	-	-				
HCM Control Delay (s)	7.2	0	-	9.7	9.7	7.3	0	-				
HCM Lane LOS	A	A	-	A	A	A	A	-				
HCM 95th %tile Q(veh)	0	-	-	0.2	0.2	0	-	-				

Intersection	
Intersection Delay, s/veh	7.3
Intersection LOS	A

Movement	EBU	EBL	EBT	EBR	WBU	WBL	WBT	WBR	NBU	NBL	NBT	NBR
Lane Configurations			↕				↕				↕	
Traffic Vol, veh/h	0	2	53	6	0	1	32	0	0	5	2	3
Future Vol, veh/h	0	2	53	6	0	1	32	0	0	5	2	3
Peak Hour Factor	0.92	0.75	0.75	0.75	0.92	0.75	0.75	0.75	0.92	0.75	0.75	0.75
Heavy Vehicles, %	2	0	4	0	2	0	0	0	2	40	0	0
Mvmt Flow	0	3	71	8	0	1	43	0	0	7	3	4
Number of Lanes	0	0	1	0	0	0	1	0	0	0	1	0

Approach	EB	WB	NB
Opposing Approach	WB	EB	SB
Opposing Lanes	1	1	1
Conflicting Approach Left	SB	NB	EB
Conflicting Lanes Left	1	1	1
Conflicting Approach Right	NB	SB	WB
Conflicting Lanes Right	1	1	1
HCM Control Delay	7.3	7.2	7.9
HCM LOS	A	A	A

Lane	NBLn1	EBLn1	WBLn1	SBLn1
Vol Left, %	50%	3%	3%	0%
Vol Thru, %	20%	87%	97%	0%
Vol Right, %	30%	10%	0%	100%
Sign Control	Stop	Stop	Stop	Stop
Traffic Vol by Lane	10	61	33	4
LT Vol	5	2	1	0
Through Vol	2	53	32	0
RT Vol	3	6	0	4
Lane Flow Rate	13	81	44	5
Geometry Grp	1	1	1	1
Degree of Util (X)	0.017	0.088	0.049	0.005
Departure Headway (Hd)	4.721	3.914	4	3.525
Convergence, Y/N	Yes	Yes	Yes	Yes
Cap	755	917	895	1006
Service Time	2.771	1.932	2.023	1.579
HCM Lane V/C Ratio	0.017	0.088	0.049	0.005
HCM Control Delay	7.9	7.3	7.2	6.6
HCM Lane LOS	A	A	A	A
HCM 95th-tile Q	0.1	0.3	0.2	0

Intersection

Intersection Delay, s/veh

Intersection LOS

Movement	SBU	SBL	SBT	SBR
Lane Configurations			↕	
Traffic Vol, veh/h	0	0	0	4
Future Vol, veh/h	0	0	0	4
Peak Hour Factor	0.92	0.75	0.75	0.75
Heavy Vehicles, %	2	0	0	0
Mvmt Flow	0	0	0	5
Number of Lanes	0	0	1	0

Approach SB

Opposing Approach	NB
Opposing Lanes	1
Conflicting Approach Left	WB
Conflicting Lanes Left	1
Conflicting Approach Right	EB
Conflicting Lanes Right	1
HCM Control Delay	6.6
HCM LOS	A

Intersection

Int Delay, s/veh 0.1

Movement	EBL	EBR	NBL	NBT	SBT	SBR
Lane Configurations	Y			Y	Y	
Traffic Vol, veh/h	1	2	8	752	896	1
Future Vol, veh/h	1	2	8	752	896	1
Conflicting Peds, #/hr	0	0	0	0	0	0
Sign Control	Stop	Stop	Free	Free	Free	Free
RT Channelized	-	None	-	None	-	None
Storage Length	0	-	-	-	-	-
Veh in Median Storage, #	0	-	-	0	0	-
Grade, %	0	-	-	0	0	-
Peak Hour Factor	91	91	91	91	91	92
Heavy Vehicles, %	2	2	2	2	2	2
Mvmt Flow	1	2	9	826	985	1

Major/Minor	Minor2	Major1	Major2
Conflicting Flow All	1829	985	986 0
Stage 1	985	-	- -
Stage 2	844	-	- -
Critical Hdwy	6.42	6.22	4.12 -
Critical Hdwy Stg 1	5.42	-	- -
Critical Hdwy Stg 2	5.42	-	- -
Follow-up Hdwy	3.518	3.318	2.218 -
Pot Cap-1 Maneuver	84	301	701 -
Stage 1	362	-	- -
Stage 2	422	-	- -
Platoon blocked, %			- -
Mov Cap-1 Maneuver	82	301	701 -
Mov Cap-2 Maneuver	82	-	- -
Stage 1	362	-	- -
Stage 2	412	-	- -

Approach	EB	NB	SB
HCM Control Delay, s	28.1	0.1	0
HCM LOS	D		

Minor Lane/Major Mvmt	NBL	NBT	EBLn1	SBT	SBR
Capacity (veh/h)	701	-	159	-	-
HCM Lane V/C Ratio	0.013	-	0.021	-	-
HCM Control Delay (s)	10.2	0	28.1	-	-
HCM Lane LOS	B	A	D	-	-
HCM 95th %tile Q(veh)	0	-	0.1	-	-

Intersection

Int Delay, s/veh 0.2

Movement	WBL	WBR	NBT	NBR	SBL	SBT
Lane Configurations	↘		↑	↗		↖
Traffic Vol, veh/h	7	3	756	9	4	972
Future Vol, veh/h	7	3	756	9	4	972
Conflicting Peds, #/hr	0	0	0	1	1	0
Sign Control	Stop	Stop	Free	Free	Free	Free
RT Channelized	-	None	-	None	-	None
Storage Length	0	-	-	125	-	-
Veh in Median Storage, #	0	-	0	-	-	0
Grade, %	0	-	0	-	-	0
Peak Hour Factor	96	96	96	96	96	96
Heavy Vehicles, %	0	0	2	0	0	1
Mvmt Flow	7	3	788	9	4	1013

Major/Minor	Minor1		Major1		Major2	
Conflicting Flow All	1810	789	0	0	789	0
Stage 1	789	-	-	-	-	-
Stage 2	1021	-	-	-	-	-
Critical Hdwy	6.4	6.2	-	-	4.1	-
Critical Hdwy Stg 1	5.4	-	-	-	-	-
Critical Hdwy Stg 2	5.4	-	-	-	-	-
Follow-up Hdwy	3.5	3.3	-	-	2.2	-
Pot Cap-1 Maneuver	88	394	-	-	840	-
Stage 1	451	-	-	-	-	-
Stage 2	351	-	-	-	-	-
Platoon blocked, %			-	-		
Mov Cap-1 Maneuver	87	394	-	-	840	-
Mov Cap-2 Maneuver	87	-	-	-	-	-
Stage 1	451	-	-	-	-	-
Stage 2	347	-	-	-	-	-

Approach	WB		NB		SB
HCM Control Delay, s	39.7		0		0
HCM LOS	E				

Minor Lane/Major Mvmt	NBT	NBRWBLn1	SBL	SBT
Capacity (veh/h)	-	- 114	840	-
HCM Lane V/C Ratio	-	- 0.091	0.005	-
HCM Control Delay (s)	-	- 39.7	9.3	0
HCM Lane LOS	-	- E	A	A
HCM 95th %tile Q(veh)	-	- 0.3	0	-

Intersection												
Int Delay, s/veh	0											
Movement	EBL	EBT	EBR	WBL	WBT	WBR	NBL	NBT	NBR	SBL	SBT	SBR
Lane Configurations		↕			↕		↕	↕		↕	↕	
Traffic Vol, veh/h	0	0	0	1	0	1	2	755	0	1	981	4
Future Vol, veh/h	0	0	0	1	0	1	2	755	0	1	981	4
Conflicting Peds, #/hr	0	0	1	1	0	0	0	0	3	3	0	0
Sign Control	Stop	Stop	Stop	Stop	Stop	Stop	Free	Free	Free	Free	Free	Free
RT Channelized	-	-	None	-	-	None	-	-	None	-	-	None
Storage Length	-	-	-	-	-	-	65	-	-	50	-	-
Veh in Median Storage, #	-	0	-	-	0	-	-	0	-	-	0	-
Grade, %	-	0	-	-	0	-	-	0	-	-	0	-
Peak Hour Factor	96	96	96	96	96	96	96	96	96	96	96	96
Heavy Vehicles, %	0	0	0	0	0	0	0	3	0	0	2	0
Mvmt Flow	0	0	0	1	0	1	2	786	0	1	1022	4
Major/Minor	Minor2			Minor1			Major1			Major2		
Conflicting Flow All	1817	1820	1025	1821	1822	789	1026	0	0	789	0	0
Stage 1	1026	1026	-	794	794	-	-	-	-	-	-	-
Stage 2	791	794	-	1027	1028	-	-	-	-	-	-	-
Critical Hdwy	7.1	6.5	6.2	7.1	6.5	6.2	4.1	-	-	4.1	-	-
Critical Hdwy Stg 1	6.1	5.5	-	6.1	5.5	-	-	-	-	-	-	-
Critical Hdwy Stg 2	6.1	5.5	-	6.1	5.5	-	-	-	-	-	-	-
Follow-up Hdwy	3.5	4	3.3	3.5	4	3.3	2.2	-	-	2.2	-	-
Pot Cap-1 Maneuver	61	78	288	60	78	394	685	-	-	840	-	-
Stage 1	286	315	-	384	403	-	-	-	-	-	-	-
Stage 2	386	403	-	285	314	-	-	-	-	-	-	-
Platoon blocked, %												
Mov Cap-1 Maneuver	61	77	288	60	77	393	684	-	-	840	-	-
Mov Cap-2 Maneuver	61	77	-	60	77	-	-	-	-	-	-	-
Stage 1	285	315	-	382	401	-	-	-	-	-	-	-
Stage 2	384	401	-	284	314	-	-	-	-	-	-	-
Approach	EB			WB			NB			SB		
HCM Control Delay, s	0			40.3			0			0		
HCM LOS	A			E								
Minor Lane/Major Mvmt	NBL	NBT	NBR	EBLn1	WBLn1	SBL	SBT	SBR				
Capacity (veh/h)	684	-	-	-	104	840	-	-				
HCM Lane V/C Ratio	0.003	-	-	-	0.02	0.001	-	-				
HCM Control Delay (s)	10.3	-	-	0	40.3	9.3	-	-				
HCM Lane LOS	B	-	-	A	E	A	-	-				
HCM 95th %tile Q(veh)	0	-	-	-	0.1	0	-	-				

Intersection

Int Delay, s/veh 0.2

Movement	WBL	WBR	NBT	NBR	SBL	SBT
Lane Configurations	Y		P		T	T
Traffic Vol, veh/h	0	11	749	0	8	973
Future Vol, veh/h	0	11	749	0	8	973
Conflicting Peds, #/hr	0	0	0	1	1	0
Sign Control	Stop	Stop	Free	Free	Free	Free
RT Channelized	-	None	-	None	-	None
Storage Length	0	-	-	-	65	-
Veh in Median Storage, #	0	-	0	-	-	0
Grade, %	0	-	0	-	-	0
Peak Hour Factor	93	93	93	93	93	93
Heavy Vehicles, %	0	9	2	0	0	1
Mvmt Flow	0	12	805	0	9	1046

Major/Minor	Minor1		Major1		Major2	
Conflicting Flow All	1869	806	0	0	806	0
Stage 1	806	-	-	-	-	-
Stage 2	1063	-	-	-	-	-
Critical Hdwy	6.4	6.29	-	-	4.1	-
Critical Hdwy Stg 1	5.4	-	-	-	-	-
Critical Hdwy Stg 2	5.4	-	-	-	-	-
Follow-up Hdwy	3.5	3.381	-	-	2.2	-
Pot Cap-1 Maneuver	80	371	-	-	828	-
Stage 1	443	-	-	-	-	-
Stage 2	335	-	-	-	-	-
Platoon blocked, %			-	-		-
Mov Cap-1 Maneuver	79	371	-	-	828	-
Mov Cap-2 Maneuver	79	-	-	-	-	-
Stage 1	443	-	-	-	-	-
Stage 2	331	-	-	-	-	-

Approach	WB		NB		SB
HCM Control Delay, s	15		0		0.1
HCM LOS	C				

Minor Lane/Major Mvmt	NBT	NBRWBLn1	SBL	SBT
Capacity (veh/h)	-	- 371	828	-
HCM Lane V/C Ratio	-	- 0.032	0.01	-
HCM Control Delay (s)	-	- 15	9.4	-
HCM Lane LOS	-	- C	A	-
HCM 95th %tile Q(veh)	-	- 0.1	0	-

Intersection

Int Delay, s/veh 6.7

Movement	WBL	WBR	NBT	NBR	SBL	SBT
Lane Configurations	Y		P			A
Traffic Vol, veh/h	3	13	1	2	6	2
Future Vol, veh/h	3	13	1	2	6	2
Conflicting Peds, #/hr	2	0	0	0	0	0
Sign Control	Stop	Stop	Free	Free	Free	Free
RT Channelized	-	None	-	None	-	None
Storage Length	0	-	-	-	-	-
Veh in Median Storage, #	0	-	0	-	-	0
Grade, %	0	-	0	-	-	0
Peak Hour Factor	75	75	75	75	75	75
Heavy Vehicles, %	33	8	0	0	0	0
Mvmt Flow	4	17	1	3	8	3

Major/Minor	Minor1		Major1		Major2	
Conflicting Flow All	24	3	0	0	4	0
Stage 1	3	-	-	-	-	-
Stage 2	21	-	-	-	-	-
Critical Hdwy	6.73	6.28	-	-	4.1	-
Critical Hdwy Stg 1	5.73	-	-	-	-	-
Critical Hdwy Stg 2	5.73	-	-	-	-	-
Follow-up Hdwy	3.797	3.372	-	-	2.2	-
Pot Cap-1 Maneuver	918	1064	-	-	1631	-
Stage 1	945	-	-	-	-	-
Stage 2	927	-	-	-	-	-
Platoon blocked, %			-	-		-
Mov Cap-1 Maneuver	912	1064	-	-	1631	-
Mov Cap-2 Maneuver	912	-	-	-	-	-
Stage 1	945	-	-	-	-	-
Stage 2	921	-	-	-	-	-

Approach	WB		NB		SB
HCM Control Delay, s	8.6		0		5.4
HCM LOS	A				

Minor Lane/Major Mvmt	NBT	NBRWBLn1	SBL	SBT
Capacity (veh/h)	-	- 1032	1631	-
HCM Lane V/C Ratio	-	- 0.021	0.005	-
HCM Control Delay (s)	-	- 8.6	7.2	0
HCM Lane LOS	-	- A	A	A
HCM 95th %tile Q(veh)	-	- 0.1	0	-

Intersection

Int Delay, s/veh 5.9

Movement	EBT	EBR	WBL	WBT	NBL	NBR
Lane Configurations	↔			↔	↔	
Traffic Vol, veh/h	2	5	1	0	13	1
Future Vol, veh/h	2	5	1	0	13	1
Conflicting Peds, #/hr	0	1	1	0	0	0
Sign Control	Free	Free	Free	Free	Stop	Stop
RT Channelized	-	None	-	None	-	None
Storage Length	-	-	-	-	0	-
Veh in Median Storage, #	0	-	-	0	0	-
Grade, %	0	-	-	0	0	-
Peak Hour Factor	79	79	79	79	79	79
Heavy Vehicles, %	0	0	100	0	15	0
Mvmt Flow	3	6	1	0	16	1

Major/Minor	Major1	Major2	Minor1
Conflicting Flow All	0	10	10
Stage 1	-	-	7
Stage 2	-	-	3
Critical Hdwy	-	5.1	6.55
Critical Hdwy Stg 1	-	-	5.55
Critical Hdwy Stg 2	-	-	5.55
Follow-up Hdwy	-	3.1	3.635
Pot Cap-1 Maneuver	-	1150	977
Stage 1	-	-	983
Stage 2	-	-	987
Platoon blocked, %	-	-	-
Mov Cap-1 Maneuver	-	1150	975
Mov Cap-2 Maneuver	-	-	975
Stage 1	-	-	982
Stage 2	-	-	986

Approach	EB	WB	NB
HCM Control Delay, s	0	8.1	8.7
HCM LOS			A

Minor Lane/Major Mvmt	NBLn1	EBT	EBR	WBL	WBT
Capacity (veh/h)	982	-	-	1150	-
HCM Lane V/C Ratio	0.018	-	-	0.001	-
HCM Control Delay (s)	8.7	-	-	8.1	0
HCM Lane LOS	A	-	-	A	A
HCM 95th %tile Q(veh)	0.1	-	-	0	-

Intersection

Int Delay, s/veh 0.8

Movement	EBL	EBT	EBR	WBL	WBT	WBR	NBL	NBT	NBR	SBL	SBT	SBR
Lane Configurations		↔			↔		↑	↑		↑	↑	
Traffic Vol, veh/h	0	0	6	6	1	25	9	728	2	22	943	5
Future Vol, veh/h	0	0	6	6	1	25	9	728	2	22	943	5
Conflicting Peds, #/hr	0	0	0	0	0	0	0	0	1	1	0	0
Sign Control	Stop	Stop	Stop	Stop	Stop	Stop	Free	Free	Free	Free	Free	Free
RT Channelized	-	-	None	-	-	None	-	-	None	-	-	None
Storage Length	-	-	-	-	-	-	125	-	-	125	-	-
Veh in Median Storage, #	-	0	-	-	0	-	-	0	-	-	0	-
Grade, %	-	0	-	-	0	-	-	0	-	-	0	-
Peak Hour Factor	95	95	95	95	95	95	95	95	95	95	95	95
Heavy Vehicles, %	0	0	0	17	0	4	0	3	0	5	1	0
Mvmt Flow	0	0	6	6	1	26	9	766	2	23	993	5

Major/Minor	Minor2			Minor1			Major1			Major2		
Conflicting Flow All	1842	1830	995	1832	1831	768	998	0	0	769	0	0
Stage 1	1042	1042	-	787	787	-	-	-	-	-	-	-
Stage 2	800	788	-	1045	1044	-	-	-	-	-	-	-
Critical Hdwy	7.1	6.5	6.2	7.27	6.5	6.24	4.1	-	-	4.15	-	-
Critical Hdwy Stg 1	6.1	5.5	-	6.27	5.5	-	-	-	-	-	-	-
Critical Hdwy Stg 2	6.1	5.5	-	6.27	5.5	-	-	-	-	-	-	-
Follow-up Hdwy	3.5	4	3.3	3.653	4	3.336	2.2	-	-	2.245	-	-
Pot Cap-1 Maneuver	58	77	300	54	77	398	701	-	-	832	-	-
Stage 1	280	309	-	363	406	-	-	-	-	-	-	-
Stage 2	382	405	-	259	309	-	-	-	-	-	-	-
Platoon blocked, %												
Mov Cap-1 Maneuver	52	74	300	51	74	398	701	-	-	832	-	-
Mov Cap-2 Maneuver	52	74	-	51	74	-	-	-	-	-	-	-
Stage 1	276	300	-	358	400	-	-	-	-	-	-	-
Stage 2	351	399	-	247	300	-	-	-	-	-	-	-

Approach	EB	WB	NB	SB
HCM Control Delay, s	17.3	32.3	0.1	0.2
HCM LOS	C	D		

Minor Lane/Major Mvmt	NBL	NBT	NBR	EBLn1WBLn1	SBL	SBT	SBR
Capacity (veh/h)	701	-	-	300	165	832	-
HCM Lane V/C Ratio	0.014	-	-	0.021	0.204	0.028	-
HCM Control Delay (s)	10.2	-	-	17.3	32.3	9.5	-
HCM Lane LOS	B	-	-	C	D	A	-
HCM 95th %tile Q(veh)	0	-	-	0.1	0.7	0.1	-

Intersection												
Int Delay, s/veh	3.5											
Movement	EBL	EBT	EBR	WBL	WBT	WBR	NBL	NBT	NBR	SBL	SBT	SBR
Lane Configurations		↔			↔		↔	↔		↔	↔	
Traffic Vol, veh/h	6	3	21	23	3	23	28	712	36	7	943	7
Future Vol, veh/h	6	3	21	23	3	23	28	712	36	7	943	7
Conflicting Peds, #/hr	1	0	0	0	0	1	0	0	0	0	0	0
Sign Control	Stop	Stop	Stop	Stop	Stop	Stop	Free	Free	Free	Free	Free	Free
RT Channelized	-	-	None	-	-	None	-	-	None	-	-	None
Storage Length	-	-	-	-	-	-	80	-	-	125	-	-
Veh in Median Storage, #	-	0	-	-	0	-	-	0	-	-	0	-
Grade, %	-	0	-	-	0	-	-	0	-	-	0	-
Peak Hour Factor	95	95	95	95	95	95	95	95	95	95	95	95
Heavy Vehicles, %	2	2	2	2	2	2	2	2	2	2	2	2
Mvmt Flow	6	3	22	24	3	24	29	749	38	7	993	7
Major/Minor	Minor2			Minor1			Major1			Major2		
Conflicting Flow All	1853	1857	996	1851	1842	769	1000	0	0	787	0	0
Stage 1	1011	1011	-	827	827	-	-	-	-	-	-	-
Stage 2	842	846	-	1024	1015	-	-	-	-	-	-	-
Critical Hdwy	7.12	6.52	6.22	7.12	6.52	6.22	4.12	-	-	4.12	-	-
Critical Hdwy Stg 1	6.12	5.52	-	6.12	5.52	-	-	-	-	-	-	-
Critical Hdwy Stg 2	6.12	5.52	-	6.12	5.52	-	-	-	-	-	-	-
Follow-up Hdwy	3.518	4.018	3.318	3.518	4.018	3.318	2.218	-	-	2.218	-	-
Pot Cap-1 Maneuver	57	74	297	57	75	401	692	-	-	832	-	-
Stage 1	289	317	-	366	386	-	-	-	-	-	-	-
Stage 2	359	378	-	284	316	-	-	-	-	-	-	-
Platoon blocked, %												
Mov Cap-1 Maneuver	50	70	297	49	71	401	692	-	-	831	-	-
Mov Cap-2 Maneuver	50	70	-	49	71	-	-	-	-	-	-	-
Stage 1	277	314	-	351	370	-	-	-	-	-	-	-
Stage 2	320	362	-	258	313	-	-	-	-	-	-	-
Approach	EB			WB			NB			SB		
HCM Control Delay, s	42.1			96.1			0.4			0.1		
HCM LOS	E			F								
Minor Lane/Major Mvmt	NBL	NBT	NBR	EBLn1	WBLn1	SBL	SBT	SBR				
Capacity (veh/h)	692	-	-	128	86	831	-	-				
HCM Lane V/C Ratio	0.043	-	-	0.247	0.6	0.009	-	-				
HCM Control Delay (s)	10.4	-	-	42.1	96.1	9.4	-	-				
HCM Lane LOS	B	-	-	E	F	A	-	-				
HCM 95th %tile Q(veh)	0.1	-	-	0.9	2.7	0	-	-				

Intersection

Int Delay, s/veh 4.5

Movement	EBL	EBT	EBR	WBL	WBT	WBR	NBL	NBT	NBR	SBL	SBT	SBR
Lane Configurations		↕			↕			↕			↕	
Traffic Vol, veh/h	25	33	2	5	31	17	10	9	3	6	17	8
Future Vol, veh/h	25	33	2	5	31	17	10	9	3	6	17	8
Conflicting Peds, #/hr	1	0	0	0	0	1	0	0	2	2	0	0
Sign Control	Free	Free	Free	Free	Free	Free	Stop	Stop	Stop	Stop	Stop	Stop
RT Channelized	-	-	None	-	-	None	-	-	None	-	-	None
Storage Length	-	-	-	-	-	-	-	-	-	-	-	-
Veh in Median Storage, #	-	0	-	-	0	-	-	0	-	-	0	-
Grade, %	-	0	-	-	0	-	-	0	-	-	0	-
Peak Hour Factor	83	83	83	83	83	83	83	83	83	83	83	83
Heavy Vehicles, %	0	0	0	0	0	0	0	0	0	0	0	0
Mvmt Flow	30	40	2	6	37	20	12	11	4	7	20	10

Major/Minor	Major1			Major2			Minor1			Minor2		
Conflicting Flow All	59	0	0	42	0	0	176	172	43	171	163	49
Stage 1	-	-	-	-	-	-	101	101	-	61	61	-
Stage 2	-	-	-	-	-	-	75	71	-	110	102	-
Critical Hdwy	4.1	-	-	4.1	-	-	7.1	6.5	6.2	7.1	6.5	6.2
Critical Hdwy Stg 1	-	-	-	-	-	-	6.1	5.5	-	6.1	5.5	-
Critical Hdwy Stg 2	-	-	-	-	-	-	6.1	5.5	-	6.1	5.5	-
Follow-up Hdwy	2.2	-	-	2.2	-	-	3.5	4	3.3	3.5	4	3.3
Pot Cap-1 Maneuver	1558	-	-	1580	-	-	791	725	1033	797	733	1025
Stage 1	-	-	-	-	-	-	910	815	-	955	848	-
Stage 2	-	-	-	-	-	-	939	840	-	900	815	-
Platoon blocked, %	-	-	-	-	-	-	-	-	-	-	-	-
Mov Cap-1 Maneuver	1558	-	-	1577	-	-	752	707	1031	768	715	1024
Mov Cap-2 Maneuver	-	-	-	-	-	-	752	707	-	768	715	-
Stage 1	-	-	-	-	-	-	892	799	-	935	844	-
Stage 2	-	-	-	-	-	-	904	836	-	865	799	-

Approach	EB	WB	NB	SB
HCM Control Delay, s	3.1	0.7	9.9	9.8
HCM LOS			A	A

Minor Lane/Major Mvmt	NBLn1	EBL	EBT	EBR	WBL	WBT	WBR	SBLn1
Capacity (veh/h)	760	1558	-	-	1577	-	-	787
HCM Lane V/C Ratio	0.035	0.019	-	-	0.004	-	-	0.047
HCM Control Delay (s)	9.9	7.4	0	-	7.3	0	-	9.8
HCM Lane LOS	A	A	A	-	A	A	-	A
HCM 95th %tile Q(veh)	0.1	0.1	-	-	0	-	-	0.1

Intersection

Int Delay, s/veh 6.9

Movement	EBL	EBT	EBR	WBL	WBT	WBR	NBL	NBT	NBR	SBL	SBT	SBR
Lane Configurations		↕			↕			↕			↕	
Traffic Vol, veh/h	2	37	3	10	37	2	7	13	7	8	16	3
Future Vol, veh/h	2	37	3	10	37	2	7	13	7	8	16	3
Conflicting Peds, #/hr	4	0	0	0	0	4	1	0	1	1	0	1
Sign Control	Stop	Stop	Stop	Stop	Stop	Stop	Free	Free	Free	Free	Free	Free
RT Channelized	-	-	None	-	-	None	-	-	None	-	-	None
Storage Length	-	-	-	-	-	-	-	-	-	-	-	-
Veh in Median Storage, #	-	0	-	-	0	-	-	0	-	-	0	-
Grade, %	-	0	-	-	0	-	-	0	-	-	0	-
Peak Hour Factor	84	84	84	84	84	84	84	84	84	84	84	84
Heavy Vehicles, %	0	0	0	0	0	0	0	8	14	0	6	0
Mvmt Flow	2	44	4	12	44	2	8	15	8	10	19	4

Major/Minor	Minor2			Minor1			Major1			Major2		
Conflicting Flow All	105	82	22	101	80	25	24	0	0	25	0	0
Stage 1	41	41	-	37	37	-	-	-	-	-	-	-
Stage 2	64	41	-	64	43	-	-	-	-	-	-	-
Critical Hdwy	7.1	6.5	6.2	7.1	6.5	6.2	4.1	-	-	4.1	-	-
Critical Hdwy Stg 1	6.1	5.5	-	6.1	5.5	-	-	-	-	-	-	-
Critical Hdwy Stg 2	6.1	5.5	-	6.1	5.5	-	-	-	-	-	-	-
Follow-up Hdwy	3.5	4	3.3	3.5	4	3.3	2.2	-	-	2.2	-	-
Pot Cap-1 Maneuver	880	812	1061	885	814	1057	1604	-	-	1603	-	-
Stage 1	979	865	-	984	868	-	-	-	-	-	-	-
Stage 2	952	865	-	952	863	-	-	-	-	-	-	-
Platoon blocked, %												
Mov Cap-1 Maneuver	830	802	1060	837	804	1052	1604	-	-	1597	-	-
Mov Cap-2 Maneuver	830	802	-	837	804	-	-	-	-	-	-	-
Stage 1	973	859	-	978	863	-	-	-	-	-	-	-
Stage 2	893	860	-	895	857	-	-	-	-	-	-	-

Approach	EB	WB	NB	SB
HCM Control Delay, s	9.7	9.7	1.9	2.2
HCM LOS	A	A		

Minor Lane/Major Mvmt	NBL	NBT	NBR	EBLn1	WBLn1	SBL	SBT	SBR
Capacity (veh/h)	1604	-	-	818	818	1597	-	-
HCM Lane V/C Ratio	0.005	-	-	0.061	0.071	0.006	-	-
HCM Control Delay (s)	7.3	0	-	9.7	9.7	7.3	0	-
HCM Lane LOS	A	A	-	A	A	A	A	-
HCM 95th %tile Q(veh)	0	-	-	0.2	0.2	0	-	-

Intersection	
Intersection Delay, s/veh	7.2
Intersection LOS	A

Movement	EBU	EBL	EBT	EBR	WBU	WBL	WBT	WBR	NBU	NBL	NBT	NBR
Lane Configurations			↕				↕				↕	
Traffic Vol, veh/h	0	4	45	3	0	2	40	0	0	4	1	4
Future Vol, veh/h	0	4	45	3	0	2	40	0	0	4	1	4
Peak Hour Factor	0.92	0.83	0.83	0.83	0.92	0.83	0.83	0.83	0.92	0.83	0.83	0.83
Heavy Vehicles, %	2	0	2	0	2	0	0	0	2	0	0	0
Mvmt Flow	0	5	54	4	0	2	48	0	0	5	1	5
Number of Lanes	0	0	1	0	0	0	1	0	0	0	1	0

Approach	EB	WB	NB
Opposing Approach	WB	EB	SB
Opposing Lanes	1	1	1
Conflicting Approach Left	SB	NB	EB
Conflicting Lanes Left	1	1	1
Conflicting Approach Right	NB	SB	WB
Conflicting Lanes Right	1	1	1
HCM Control Delay	7.3	7.2	7
HCM LOS	A	A	A

Lane	NBLn1	EBLn1	WBLn1	SBLn1
Vol Left, %	44%	8%	5%	0%
Vol Thru, %	11%	87%	95%	14%
Vol Right, %	44%	6%	0%	86%
Sign Control	Stop	Stop	Stop	Stop
Traffic Vol by Lane	9	52	42	7
LT Vol	4	4	2	0
Through Vol	1	45	40	1
RT Vol	4	3	0	6
Lane Flow Rate	11	63	51	8
Geometry Grp	1	1	1	1
Degree of Util (X)	0.012	0.069	0.056	0.008
Departure Headway (Hd)	3.924	3.952	3.99	3.59
Convergence, Y/N	Yes	Yes	Yes	Yes
Cap	907	908	899	990
Service Time	1.971	1.967	2.007	1.638
HCM Lane V/C Ratio	0.012	0.069	0.057	0.008
HCM Control Delay	7	7.3	7.2	6.7
HCM Lane LOS	A	A	A	A
HCM 95th-tile Q	0	0.2	0.2	0

Intersection

Intersection Delay, s/veh
 Intersection LOS

Movement	SBU	SBL	SBT	SBR
Lane Configurations			↕	
Traffic Vol, veh/h	0	0	1	6
Future Vol, veh/h	0	0	1	6
Peak Hour Factor	0.92	0.83	0.83	0.83
Heavy Vehicles, %	2	0	0	0
Mvmt Flow	0	0	1	7
Number of Lanes	0	0	1	0

Approach SB

Opposing Approach	NB
Opposing Lanes	1
Conflicting Approach Left	WB
Conflicting Lanes Left	1
Conflicting Approach Right	EB
Conflicting Lanes Right	1
HCM Control Delay	6.7
HCM LOS	A

Intersection

Int Delay, s/veh 0.2

Movement	EBL	EBR	NBL	NBT	SBT	SBR
Lane Configurations	Y			Y	Y	
Traffic Vol, veh/h	3	8	4	739	950	5
Future Vol, veh/h	3	8	4	739	950	5
Conflicting Peds, #/hr	0	0	1	0	0	1
Sign Control	Stop	Stop	Free	Free	Free	Free
RT Channelized	-	None	-	None	-	None
Storage Length	0	-	-	-	-	-
Veh in Median Storage, #	0	-	-	0	0	-
Grade, %	0	-	-	0	0	-
Peak Hour Factor	95	95	95	95	95	95
Heavy Vehicles, %	2	2	2	2	2	2
Mvmt Flow	3	8	4	778	1000	5

Major/Minor	Minor2	Major1		Major2	
Conflicting Flow All	1790	1004	1006	0	0
Stage 1	1004	-	-	-	-
Stage 2	786	-	-	-	-
Critical Hdwy	7.12	6.22	4.12	-	-
Critical Hdwy Stg 1	6.12	-	-	-	-
Critical Hdwy Stg 2	6.12	-	-	-	-
Follow-up Hdwy	3.518	3.318	2.218	-	-
Pot Cap-1 Maneuver	63	294	689	-	-
Stage 1	291	-	-	-	-
Stage 2	385	-	-	-	-
Platoon blocked, %				-	-
Mov Cap-1 Maneuver	62	294	689	-	-
Mov Cap-2 Maneuver	62	-	-	-	-
Stage 1	288	-	-	-	-
Stage 2	381	-	-	-	-

Approach	EB	NB	SB
HCM Control Delay, s	31.8	0.1	0
HCM LOS	D		

Minor Lane/Major Mvmt	NBL	NBT	EBLn1	SBT	SBR
Capacity (veh/h)	689	-	146	-	-
HCM Lane V/C Ratio	0.006	-	0.079	-	-
HCM Control Delay (s)	10.3	0	31.8	-	-
HCM Lane LOS	B	A	D	-	-
HCM 95th %tile Q(veh)	0	-	0.3	-	-

Appendix 7 Background with Project Level- of-Service Worksheets

Intersection

Int Delay, s/veh 0.4

Movement	WBL	WBR	NBT	NBR	SBL	SBT
Lane Configurations	↘		↑	↗		↖
Traffic Vol, veh/h	14	7	711	15	1	588
Future Vol, veh/h	14	7	711	15	1	588
Conflicting Peds, #/hr	0	0	0	0	0	0
Sign Control	Stop	Stop	Free	Free	Free	Free
RT Channelized	-	None	-	None	-	None
Storage Length	0	-	-	125	-	-
Veh in Median Storage, #	0	-	0	-	-	0
Grade, %	0	-	0	-	-	0
Peak Hour Factor	92	92	92	92	92	92
Heavy Vehicles, %	0	0	6	0	0	4
Mvmt Flow	15	8	773	16	1	639

Major/Minor	Minor1		Major1		Major2	
Conflicting Flow All	1414	773	0	0	773	0
Stage 1	773	-	-	-	-	-
Stage 2	641	-	-	-	-	-
Critical Hdwy	6.4	6.2	-	-	4.1	-
Critical Hdwy Stg 1	5.4	-	-	-	-	-
Critical Hdwy Stg 2	5.4	-	-	-	-	-
Follow-up Hdwy	3.5	3.3	-	-	2.2	-
Pot Cap-1 Maneuver	153	402	-	-	851	-
Stage 1	459	-	-	-	-	-
Stage 2	528	-	-	-	-	-
Platoon blocked, %			-	-		
Mov Cap-1 Maneuver	153	402	-	-	851	-
Mov Cap-2 Maneuver	153	-	-	-	-	-
Stage 1	459	-	-	-	-	-
Stage 2	527	-	-	-	-	-

Approach	WB		NB		SB
HCM Control Delay, s	26.1		0		0
HCM LOS	D				

Minor Lane/Major Mvmt	NBT	NBRWBLn1	SBL	SBT
Capacity (veh/h)	-	- 193	851	-
HCM Lane V/C Ratio	-	- 0.118	0.001	-
HCM Control Delay (s)	-	- 26.1	9.2	0
HCM Lane LOS	-	- D	A	A
HCM 95th %tile Q(veh)	-	- 0.4	0	-

Intersection

Int Delay, s/veh 0.1

Movement	EBL	EBT	EBR	WBL	WBT	WBR	NBL	NBT	NBR	SBL	SBT	SBR
Lane Configurations		↔			↔		↑	↑		↑	↑	
Traffic Vol, veh/h	4	0	1	0	0	0	0	716	0	0	614	4
Future Vol, veh/h	4	0	1	0	0	0	0	716	0	0	614	4
Conflicting Peds, #/hr	1	0	0	0	0	1	1	0	1	1	0	1
Sign Control	Stop	Stop	Stop	Stop	Stop	Stop	Free	Free	Free	Free	Free	Free
RT Channelized	-	-	None	-	-	None	-	-	None	-	-	None
Storage Length	-	-	-	-	-	-	65	-	-	50	-	-
Veh in Median Storage, #	-	0	-	-	0	-	-	0	-	-	0	-
Grade, %	-	0	-	-	0	-	-	0	-	-	0	-
Peak Hour Factor	93	93	93	93	93	93	93	93	93	93	93	93
Heavy Vehicles, %	0	0	0	0	0	0	0	6	0	0	4	0
Mvmt Flow	4	0	1	0	0	0	0	770	0	0	660	4

Major/Minor	Minor2			Minor1			Major1			Major2		
Conflicting Flow All	1434	1434	663	1434	1437	772	666	0	0	771	0	0
Stage 1	663	663	-	771	771	-	-	-	-	-	-	-
Stage 2	771	771	-	663	666	-	-	-	-	-	-	-
Critical Hdwy	7.1	6.5	6.2	7.1	6.5	6.2	4.1	-	-	4.1	-	-
Critical Hdwy Stg 1	6.1	5.5	-	6.1	5.5	-	-	-	-	-	-	-
Critical Hdwy Stg 2	6.1	5.5	-	6.1	5.5	-	-	-	-	-	-	-
Follow-up Hdwy	3.5	4	3.3	3.5	4	3.3	2.2	-	-	2.2	-	-
Pot Cap-1 Maneuver	113	135	465	113	135	403	933	-	-	853	-	-
Stage 1	454	462	-	396	413	-	-	-	-	-	-	-
Stage 2	396	413	-	454	460	-	-	-	-	-	-	-
Platoon blocked, %												
Mov Cap-1 Maneuver	113	135	465	113	135	402	933	-	-	852	-	-
Mov Cap-2 Maneuver	113	135	-	113	135	-	-	-	-	-	-	-
Stage 1	454	462	-	396	413	-	-	-	-	-	-	-
Stage 2	396	413	-	453	460	-	-	-	-	-	-	-

Approach	EB	WB	NB	SB
HCM Control Delay, s	33.2	0	0	0
HCM LOS	D	A		

Minor Lane/Major Mvmt	NBL	NBT	NBR	EBLn1WBLn1	SBL	SBT	SBR
Capacity (veh/h)	933	-	-	133	-	852	-
HCM Lane V/C Ratio	-	-	-	0.04	-	-	-
HCM Control Delay (s)	0	-	-	33.2	0	0	-
HCM Lane LOS	A	-	-	D	A	A	-
HCM 95th %tile Q(veh)	0	-	-	0.1	-	0	-

Intersection

Int Delay, s/veh 0.8

Movement	WBL	WBR	NBT	NBR	SBL	SBT
Lane Configurations	↕		↔		↕	↕
Traffic Vol, veh/h	14	38	675	4	9	599
Future Vol, veh/h	14	38	675	4	9	599
Conflicting Peds, #/hr	0	0	0	0	0	0
Sign Control	Stop	Stop	Free	Free	Free	Free
RT Channelized	-	None	-	None	-	None
Storage Length	0	-	-	-	65	-
Veh in Median Storage, #	0	-	0	-	-	0
Grade, %	0	-	0	-	-	0
Peak Hour Factor	92	92	92	92	92	92
Heavy Vehicles, %	0	0	6	0	0	4
Mvmt Flow	15	41	734	4	10	651

Major/Minor	Minor1		Major1		Major2	
Conflicting Flow All	1407	736	0	0	738	0
Stage 1	736	-	-	-	-	-
Stage 2	671	-	-	-	-	-
Critical Hdwy	6.4	6.2	-	-	4.1	-
Critical Hdwy Stg 1	5.4	-	-	-	-	-
Critical Hdwy Stg 2	5.4	-	-	-	-	-
Follow-up Hdwy	3.5	3.3	-	-	2.2	-
Pot Cap-1 Maneuver	155	422	-	-	877	-
Stage 1	477	-	-	-	-	-
Stage 2	512	-	-	-	-	-
Platoon blocked, %			-	-		-
Mov Cap-1 Maneuver	153	422	-	-	877	-
Mov Cap-2 Maneuver	153	-	-	-	-	-
Stage 1	477	-	-	-	-	-
Stage 2	506	-	-	-	-	-

Approach	WB		NB		SB
HCM Control Delay, s	20.7		0		0.1
HCM LOS	C				

Minor Lane/Major Mvmt	NBT	NBRWBLn1	SBL	SBT
Capacity (veh/h)	-	- 286	877	-
HCM Lane V/C Ratio	-	- 0.198	0.011	-
HCM Control Delay (s)	-	- 20.7	9.2	-
HCM Lane LOS	-	- C	A	-
HCM 95th %tile Q(veh)	-	- 0.7	0	-

Intersection						
Int Delay, s/veh	7.6					
Movement	WBL	WBR	NBT	NBR	SBL	SBT
Lane Configurations	Y		P			A
Traffic Vol, veh/h	1	22	1	0	5	1
Future Vol, veh/h	1	22	1	0	5	1
Conflicting Peds, #/hr	0	0	0	0	0	0
Sign Control	Stop	Stop	Free	Free	Free	Free
RT Channelized	-	None	-	None	-	None
Storage Length	0	-	-	-	-	-
Veh in Median Storage, #	0	-	0	-	-	0
Grade, %	0	-	0	-	-	0
Peak Hour Factor	75	75	75	75	75	75
Heavy Vehicles, %	0	0	0	0	0	0
Mvmt Flow	1	29	1	0	7	1
Major/Minor	Minor1	Major1		Major2		
Conflicting Flow All	16	1	0	0	1	0
Stage 1	1	-	-	-	-	-
Stage 2	15	-	-	-	-	-
Critical Hdwy	6.4	6.2	-	-	4.1	-
Critical Hdwy Stg 1	5.4	-	-	-	-	-
Critical Hdwy Stg 2	5.4	-	-	-	-	-
Follow-up Hdwy	3.5	3.3	-	-	2.2	-
Pot Cap-1 Maneuver	1008	1090	-	-	1635	-
Stage 1	1028	-	-	-	-	-
Stage 2	1013	-	-	-	-	-
Platoon blocked, %			-	-		-
Mov Cap-1 Maneuver	1004	1090	-	-	1635	-
Mov Cap-2 Maneuver	1004	-	-	-	-	-
Stage 1	1028	-	-	-	-	-
Stage 2	1009	-	-	-	-	-
Approach	WB	NB		SB		
HCM Control Delay, s	8.4	0		6		
HCM LOS	A					
Minor Lane/Major Mvmt	NBT	NBRWBLn1	SBL	SBT		
Capacity (veh/h)	-	- 1086	1635	-		
HCM Lane V/C Ratio	-	- 0.028	0.004	-		
HCM Control Delay (s)	-	- 8.4	7.2	0		
HCM Lane LOS	-	- A	A	A		
HCM 95th %tile Q(veh)	-	- 0.1	0	-		

Intersection

Int Delay, s/veh 5.7

Movement	EBT	EBR	WBL	WBT	NBL	NBR
Lane Configurations	↔		↔		↔	
Traffic Vol, veh/h	2	3	0	4	18	0
Future Vol, veh/h	2	3	0	4	18	0
Conflicting Peds, #/hr	0	0	0	0	0	1
Sign Control	Free	Free	Free	Free	Stop	Stop
RT Channelized	-	None	-	None	-	None
Storage Length	-	-	-	-	0	-
Veh in Median Storage, #	0	-	-	0	0	-
Grade, %	0	-	-	0	0	-
Peak Hour Factor	70	70	70	70	70	70
Heavy Vehicles, %	0	0	0	0	0	0
Mvmt Flow	3	4	0	6	26	0

Major/Minor	Major1		Major2		Minor1	
Conflicting Flow All	0	0	7	0	11	6
Stage 1	-	-	-	-	5	-
Stage 2	-	-	-	-	6	-
Critical Hdwy	-	-	4.1	-	6.4	6.2
Critical Hdwy Stg 1	-	-	-	-	5.4	-
Critical Hdwy Stg 2	-	-	-	-	5.4	-
Follow-up Hdwy	-	-	2.2	-	3.5	3.3
Pot Cap-1 Maneuver	-	-	1627	-	1014	1083
Stage 1	-	-	-	-	1023	-
Stage 2	-	-	-	-	1022	-
Platoon blocked, %	-	-	-	-	-	-
Mov Cap-1 Maneuver	-	-	1625	-	1014	1082
Mov Cap-2 Maneuver	-	-	-	-	1014	-
Stage 1	-	-	-	-	1023	-
Stage 2	-	-	-	-	1022	-

Approach	EB	WB	NB
HCM Control Delay, s	0	0	8.6
HCM LOS			A

Minor Lane/Major Mvmt	NBLn1	EBT	EBR	WBL	WBT
Capacity (veh/h)	1014	-	-	1625	-
HCM Lane V/C Ratio	0.025	-	-	-	-
HCM Control Delay (s)	8.6	-	-	0	-
HCM Lane LOS	A	-	-	A	-
HCM 95th %tile Q(veh)	0.1	-	-	0	-

Intersection

Int Delay, s/veh 0.6

Movement	EBL	EBT	EBR	WBL	WBT	WBR	NBL	NBT	NBR	SBL	SBT	SBR
Lane Configurations		↔			↔		↖	↗		↖	↗	
Traffic Vol, veh/h	3	0	5	2	0	26	4	652	4	10	596	0
Future Vol, veh/h	3	0	5	2	0	26	4	652	4	10	596	0
Conflicting Peds, #/hr	0	0	0	0	0	0	1	0	0	0	0	1
Sign Control	Stop	Stop	Stop	Stop	Stop	Stop	Free	Free	Free	Free	Free	Free
RT Channelized	-	-	None	-	-	None	-	-	None	-	-	None
Storage Length	-	-	-	-	-	-	125	-	-	125	-	-
Veh in Median Storage, #	-	0	-	-	0	-	-	0	-	-	0	-
Grade, %	-	0	-	-	0	-	-	0	-	-	0	-
Peak Hour Factor	90	90	90	90	90	90	90	90	90	90	90	90
Heavy Vehicles, %	0	0	0	0	0	4	0	6	0	0	4	0
Mvmt Flow	3	0	6	2	0	29	4	724	4	11	662	0

Major/Minor	Minor2			Minor1			Major1			Major2		
Conflicting Flow All	1435	1423	663	1423	1421	727	663	0	0	729	0	0
Stage 1	685	685	-	736	736	-	-	-	-	-	-	-
Stage 2	750	738	-	687	685	-	-	-	-	-	-	-
Critical Hdwy	7.1	6.5	6.2	7.1	6.5	6.24	4.1	-	-	4.1	-	-
Critical Hdwy Stg 1	6.1	5.5	-	6.1	5.5	-	-	-	-	-	-	-
Critical Hdwy Stg 2	6.1	5.5	-	6.1	5.5	-	-	-	-	-	-	-
Follow-up Hdwy	3.5	4	3.3	3.5	4	3.336	2.2	-	-	2.2	-	-
Pot Cap-1 Maneuver	113	137	465	115	138	421	935	-	-	884	-	-
Stage 1	441	451	-	414	428	-	-	-	-	-	-	-
Stage 2	407	427	-	440	451	-	-	-	-	-	-	-
Platoon blocked, %												
Mov Cap-1 Maneuver	104	135	465	112	136	421	935	-	-	884	-	-
Mov Cap-2 Maneuver	104	135	-	112	136	-	-	-	-	-	-	-
Stage 1	439	445	-	412	426	-	-	-	-	-	-	-
Stage 2	377	425	-	429	445	-	-	-	-	-	-	-

Approach	EB	WB	NB	SB
HCM Control Delay, s	23.6	16.2	0.1	0.2
HCM LOS	C	C		

Minor Lane/Major Mvmt	NBL	NBT	NBR	EBLn1WBLn1	SBL	SBT	SBR
Capacity (veh/h)	935	-	-	202	352	884	-
HCM Lane V/C Ratio	0.005	-	-	0.044	0.088	0.013	-
HCM Control Delay (s)	8.9	-	-	23.6	16.2	9.1	-
HCM Lane LOS	A	-	-	C	C	A	-
HCM 95th %tile Q(veh)	0	-	-	0.1	0.3	0	-

Intersection

Int Delay, s/veh 2.8

Movement	EBL	EBT	EBR	WBL	WBT	WBR	NBL	NBT	NBR	SBL	SBT	SBR
Lane Configurations		↔			↔		↔	↔		↔	↔	
Traffic Vol, veh/h	10	0	11	48	0	15	4	640	21	6	592	6
Future Vol, veh/h	10	0	11	48	0	15	4	640	21	6	592	6
Conflicting Peds, #/hr	0	0	0	0	0	0	1	0	0	0	0	1
Sign Control	Stop	Stop	Stop	Stop	Stop	Stop	Free	Free	Free	Free	Free	Free
RT Channelized	-	-	None	-	-	None	-	-	None	-	-	None
Storage Length	-	-	-	-	-	-	80	-	-	125	-	-
Veh in Median Storage, #	-	0	-	-	0	-	-	0	-	-	0	-
Grade, %	-	0	-	-	0	-	-	0	-	-	0	-
Peak Hour Factor	93	93	93	93	93	93	93	93	93	93	93	93
Heavy Vehicles, %	2	2	2	2	2	2	2	2	2	2	2	2
Mvmt Flow	11	0	12	52	0	16	4	688	23	6	637	6

Major/Minor	Minor2			Minor1			Major1			Major2		
Conflicting Flow All	1370	1373	641	1367	1365	699	644	0	0	711	0	0
Stage 1	654	654	-	708	708	-	-	-	-	-	-	-
Stage 2	716	719	-	659	657	-	-	-	-	-	-	-
Critical Hdwy	7.12	6.52	6.22	7.12	6.52	6.22	4.12	-	-	4.12	-	-
Critical Hdwy Stg 1	6.12	5.52	-	6.12	5.52	-	-	-	-	-	-	-
Critical Hdwy Stg 2	6.12	5.52	-	6.12	5.52	-	-	-	-	-	-	-
Follow-up Hdwy	3.518	4.018	3.318	3.518	4.018	3.318	2.218	-	-	2.218	-	-
Pot Cap-1 Maneuver	124	146	475	124	147	440	941	-	-	888	-	-
Stage 1	456	463	-	426	438	-	-	-	-	-	-	-
Stage 2	421	433	-	453	462	-	-	-	-	-	-	-
Platoon blocked, %												
Mov Cap-1 Maneuver	118	144	475	120	145	440	941	-	-	888	-	-
Mov Cap-2 Maneuver	118	144	-	120	145	-	-	-	-	-	-	-
Stage 1	454	459	-	424	436	-	-	-	-	-	-	-
Stage 2	404	431	-	439	458	-	-	-	-	-	-	-

Approach	EB	WB	NB	SB
HCM Control Delay, s	25.9	49.9	0.1	0.1
HCM LOS	D	E		

Minor Lane/Major Mvmt	NBL	NBT	NBR	EBLn1WBLn1	SBL	SBT	SBR
Capacity (veh/h)	941	-	-	195	145	888	-
HCM Lane V/C Ratio	0.005	-	-	0.116	0.467	0.007	-
HCM Control Delay (s)	8.8	-	-	25.9	49.9	9.1	-
HCM Lane LOS	A	-	-	D	E	A	-
HCM 95th %tile Q(veh)	0	-	-	0.4	2.2	0	-

Intersection

Int Delay, s/veh 1.6

Movement	EBL	EBT	EBR	WBL	WBT	WBR	NBL	NBT	NBR	SBL	SBT	SBR
Lane Configurations		↕			↕			↕			↕	
Traffic Vol, veh/h	6	16	0	1	65	0	3	2	0	2	2	3
Future Vol, veh/h	6	16	0	1	65	0	3	2	0	2	2	3
Conflicting Peds, #/hr	1	0	0	0	0	1	0	0	1	1	0	0
Sign Control	Free	Free	Free	Free	Free	Free	Stop	Stop	Stop	Stop	Stop	Stop
RT Channelized	-	-	None	-	-	None	-	-	None	-	-	None
Storage Length	-	-	-	-	-	-	-	-	-	-	-	-
Veh in Median Storage, #	-	0	-	-	0	-	-	0	-	-	0	-
Grade, %	-	0	-	-	0	-	-	0	-	-	0	-
Peak Hour Factor	74	74	74	74	74	74	74	74	74	74	74	74
Heavy Vehicles, %	0	0	0	0	0	0	33	0	0	0	0	0
Mvmt Flow	8	22	0	1	88	0	4	3	0	3	3	4

Major/Minor	Major1			Major2			Minor1			Minor2		
Conflicting Flow All	89	0	0	22	0	0	132	130	23	132	130	89
Stage 1	-	-	-	-	-	-	38	38	-	92	92	-
Stage 2	-	-	-	-	-	-	94	92	-	40	38	-
Critical Hdwy	4.1	-	-	4.1	-	-	7.43	6.5	6.2	7.1	6.5	6.2
Critical Hdwy Stg 1	-	-	-	-	-	-	6.43	5.5	-	6.1	5.5	-
Critical Hdwy Stg 2	-	-	-	-	-	-	6.43	5.5	-	6.1	5.5	-
Follow-up Hdwy	2.2	-	-	2.2	-	-	3.797	4	3.3	3.5	4	3.3
Pot Cap-1 Maneuver	1519	-	-	1607	-	-	773	764	1060	845	764	975
Stage 1	-	-	-	-	-	-	904	867	-	920	823	-
Stage 2	-	-	-	-	-	-	842	823	-	980	867	-
Platoon blocked, %	-	-	-	-	-	-	-	-	-	-	-	-
Mov Cap-1 Maneuver	1519	-	-	1605	-	-	764	759	1059	837	759	974
Mov Cap-2 Maneuver	-	-	-	-	-	-	764	759	-	837	759	-
Stage 1	-	-	-	-	-	-	899	863	-	915	821	-
Stage 2	-	-	-	-	-	-	835	821	-	971	863	-

Approach	EB	WB	NB	SB
HCM Control Delay, s	2	0.1	9.8	9.2
HCM LOS			A	A

Minor Lane/Major Mvmt	NBLn1	EBL	EBT	EBR	WBL	WBT	WBR	SBLn1
Capacity (veh/h)	762	1519	-	-	1605	-	-	864
HCM Lane V/C Ratio	0.009	0.005	-	-	0.001	-	-	0.011
HCM Control Delay (s)	9.8	7.4	0	-	7.2	0	-	9.2
HCM Lane LOS	A	A	A	-	A	A	-	A
HCM 95th %tile Q(veh)	0	0	-	-	0	-	-	0

Intersection

Int Delay, s/veh 7.7

Movement	EBL	EBT	EBR	WBL	WBT	WBR	NBL	NBT	NBR	SBL	SBT	SBR
Lane Configurations		↕			↕			↕			↕	
Traffic Vol, veh/h	0	14	0	1	65	9	2	17	0	1	4	0
Future Vol, veh/h	0	14	0	1	65	9	2	17	0	1	4	0
Conflicting Peds, #/hr	1	0	0	0	0	1	0	0	0	0	0	0
Sign Control	Stop	Stop	Stop	Stop	Stop	Stop	Free	Free	Free	Free	Free	Free
RT Channelized	-	-	None	-	-	None	-	-	None	-	-	None
Storage Length	-	-	-	-	-	-	-	-	-	-	-	-
Veh in Median Storage, #	-	0	-	-	0	-	-	0	-	-	0	-
Grade, %	-	0	-	-	0	-	-	0	-	-	0	-
Peak Hour Factor	83	83	83	83	83	83	83	83	83	83	83	83
Heavy Vehicles, %	0	0	0	0	0	0	0	6	0	0	0	0
Mvmt Flow	0	17	0	1	78	11	2	20	0	1	5	0

Major/Minor	Minor2			Minor1			Major1			Major2		
Conflicting Flow All	78	32	5	41	32	21	5	0	0	20	0	0
Stage 1	7	7	-	25	25	-	-	-	-	-	-	-
Stage 2	71	25	-	16	7	-	-	-	-	-	-	-
Critical Hdwy	7.1	6.5	6.2	7.1	6.5	6.2	4.1	-	-	4.1	-	-
Critical Hdwy Stg 1	6.1	5.5	-	6.1	5.5	-	-	-	-	-	-	-
Critical Hdwy Stg 2	6.1	5.5	-	6.1	5.5	-	-	-	-	-	-	-
Follow-up Hdwy	3.5	4	3.3	3.5	4	3.3	2.2	-	-	2.2	-	-
Pot Cap-1 Maneuver	916	865	1084	968	865	1062	1630	-	-	1609	-	-
Stage 1	1020	894	-	998	878	-	-	-	-	-	-	-
Stage 2	944	878	-	1009	894	-	-	-	-	-	-	-
Platoon blocked, %												
Mov Cap-1 Maneuver	842	863	1084	952	863	1061	1630	-	-	1607	-	-
Mov Cap-2 Maneuver	842	863	-	952	863	-	-	-	-	-	-	-
Stage 1	1019	893	-	997	877	-	-	-	-	-	-	-
Stage 2	849	877	-	989	893	-	-	-	-	-	-	-

Approach	EB	WB	NB	SB
HCM Control Delay, s	9.3	9.5	0.8	1.4
HCM LOS	A	A		

Minor Lane/Major Mvmt	NBL	NBT	NBR	EBLn1WBLn1	SBL	SBT	SBR
Capacity (veh/h)	1630	-	-	863	884	1607	-
HCM Lane V/C Ratio	0.001	-	-	0.02	0.102	0.001	-
HCM Control Delay (s)	7.2	0	-	9.3	9.5	7.2	0
HCM Lane LOS	A	A	-	A	A	A	A
HCM 95th %tile Q(veh)	0	-	-	0.1	0.3	0	-

Intersection	
Intersection Delay, s/veh	7.2
Intersection LOS	A

Movement	EBU	EBL	EBT	EBR	WBU	WBL	WBT	WBR	NBU	NBL	NBT	NBR
Lane Configurations			↕				↕				↕	
Traffic Vol, veh/h	0	0	17	1	0	5	63	1	0	1	1	2
Future Vol, veh/h	0	0	17	1	0	5	63	1	0	1	1	2
Peak Hour Factor	0.92	0.90	0.90	0.90	0.92	0.90	0.90	0.90	0.92	0.90	0.90	0.90
Heavy Vehicles, %	2	0	6	0	2	0	0	0	2	0	0	0
Mvmt Flow	0	0	19	1	0	6	70	1	0	1	1	2
Number of Lanes	0	0	1	0	0	0	1	0	0	0	1	0

Approach	EB	WB	NB
Opposing Approach	WB	EB	SB
Opposing Lanes	1	1	1
Conflicting Approach Left	SB	NB	EB
Conflicting Lanes Left	1	1	1
Conflicting Approach Right	NB	SB	WB
Conflicting Lanes Right	1	1	1
HCM Control Delay	7.2	7.3	6.9
HCM LOS	A	A	A

Lane	NBLn1	EBLn1	WBLn1	SBLn1
Vol Left, %	25%	0%	7%	0%
Vol Thru, %	25%	94%	91%	0%
Vol Right, %	50%	6%	1%	100%
Sign Control	Stop	Stop	Stop	Stop
Traffic Vol by Lane	4	18	69	6
LT Vol	1	0	5	0
Through Vol	1	17	63	0
RT Vol	2	1	1	6
Lane Flow Rate	4	20	77	7
Geometry Grp	1	1	1	1
Degree of Util (X)	0.005	0.022	0.084	0.006
Departure Headway (Hd)	3.823	4.045	3.94	3.47
Convergence, Y/N	Yes	Yes	Yes	Yes
Cap	932	887	913	1026
Service Time	1.861	2.061	1.946	1.51
HCM Lane V/C Ratio	0.004	0.023	0.084	0.007
HCM Control Delay	6.9	7.2	7.3	6.5
HCM Lane LOS	A	A	A	A
HCM 95th-tile Q	0	0.1	0.3	0

Intersection

Intersection Delay, s/veh
 Intersection LOS

Movement	SBU	SBL	SBT	SBR
Lane Configurations			↕	
Traffic Vol, veh/h	0	0	0	6
Future Vol, veh/h	0	0	0	6
Peak Hour Factor	0.92	0.90	0.90	0.90
Heavy Vehicles, %	2	0	0	0
Mvmt Flow	0	0	0	7
Number of Lanes	0	0	1	0

Approach SB

Opposing Approach	NB
Opposing Lanes	1
Conflicting Approach Left	WB
Conflicting Lanes Left	1
Conflicting Approach Right	EB
Conflicting Lanes Right	1
HCM Control Delay	6.5
HCM LOS	A

Intersection

Int Delay, s/veh 0.2

Movement	EBL	EBR	NBL	NBT	SBT	SBR
Lane Configurations	Y			4	4	
Traffic Vol, veh/h	3	6	7	659	598	0
Future Vol, veh/h	3	6	7	659	598	0
Conflicting Peds, #/hr	0	0	1	0	0	1
Sign Control	Stop	Stop	Free	Free	Free	Free
RT Channelized	-	None	-	None	-	None
Storage Length	0	-	-	-	-	-
Veh in Median Storage, #	0	-	-	0	0	-
Grade, %	0	-	-	0	0	-
Peak Hour Factor	93	93	93	93	93	93
Heavy Vehicles, %	2	2	2	2	2	2
Mvmt Flow	3	6	8	709	643	0

Major/Minor	Minor2	Major1	Major2
Conflicting Flow All	1368	644	0
Stage 1	644	-	-
Stage 2	724	-	-
Critical Hdwy	6.42	6.22	4.12
Critical Hdwy Stg 1	5.42	-	-
Critical Hdwy Stg 2	5.42	-	-
Follow-up Hdwy	3.518	3.318	2.218
Pot Cap-1 Maneuver	162	473	941
Stage 1	523	-	-
Stage 2	480	-	-
Platoon blocked, %			-
Mov Cap-1 Maneuver	159	473	941
Mov Cap-2 Maneuver	159	-	-
Stage 1	523	-	-
Stage 2	473	-	-

Approach	EB	NB	SB
HCM Control Delay, s	18.1	0.1	0
HCM LOS	C		

Minor Lane/Major Mvmt	NBL	NBT	EBLn1	SBT	SBR
Capacity (veh/h)	941	-	285	-	-
HCM Lane V/C Ratio	0.008	-	0.034	-	-
HCM Control Delay (s)	8.9	0	18.1	-	-
HCM Lane LOS	A	A	C	-	-
HCM 95th %tile Q(veh)	0	-	0.1	-	-

Intersection

Int Delay, s/veh 0.4

Movement	WBL	WBR	NBT	NBR	SBL	SBT
Lane Configurations	↘↙		↑	↗		↖
Traffic Vol, veh/h	11	5	739	18	5	939
Future Vol, veh/h	11	5	739	18	5	939
Conflicting Peds, #/hr	0	0	0	1	1	0
Sign Control	Stop	Stop	Free	Free	Free	Free
RT Channelized	-	None	-	None	-	None
Storage Length	0	-	-	125	-	-
Veh in Median Storage, #	0	-	0	-	-	0
Grade, %	0	-	0	-	-	0
Peak Hour Factor	95	95	95	95	95	95
Heavy Vehicles, %	0	0	2	0	0	2
Mvmt Flow	12	5	778	19	5	988

Major/Minor	Minor1		Major1		Major2	
Conflicting Flow All	1778	779	0	0	779	0
Stage 1	779	-	-	-	-	-
Stage 2	999	-	-	-	-	-
Critical Hdwy	6.4	6.2	-	-	4.1	-
Critical Hdwy Stg 1	5.4	-	-	-	-	-
Critical Hdwy Stg 2	5.4	-	-	-	-	-
Follow-up Hdwy	3.5	3.3	-	-	2.2	-
Pot Cap-1 Maneuver	92	399	-	-	847	-
Stage 1	456	-	-	-	-	-
Stage 2	359	-	-	-	-	-
Platoon blocked, %			-	-		
Mov Cap-1 Maneuver	91	399	-	-	847	-
Mov Cap-2 Maneuver	91	-	-	-	-	-
Stage 1	456	-	-	-	-	-
Stage 2	354	-	-	-	-	-

Approach	WB		NB		SB
HCM Control Delay, s	39.8		0		0
HCM LOS	E				

Minor Lane/Major Mvmt	NBT	NBRWBLn1	SBL	SBT
Capacity (veh/h)	-	-	120	847
HCM Lane V/C Ratio	-	-	0.14	0.006
HCM Control Delay (s)	-	-	39.8	9.3
HCM Lane LOS	-	-	E	A
HCM 95th %tile Q(veh)	-	-	0.5	0

Intersection

Int Delay, s/veh 0.3

Movement	EBL	EBT	EBR	WBL	WBT	WBR	NBL	NBT	NBR	SBL	SBT	SBR
Lane Configurations		↔			↔		↑	↑		↑	↑	
Traffic Vol, veh/h	5	0	4	1	0	2	0	751	0	1	935	4
Future Vol, veh/h	5	0	4	1	0	2	0	751	0	1	935	4
Conflicting Peds, #/hr	5	0	0	0	0	5	0	0	4	4	0	0
Sign Control	Stop	Stop	Stop	Stop	Stop	Stop	Free	Free	Free	Free	Free	Free
RT Channelized	-	-	None	-	-	None	-	-	None	-	-	None
Storage Length	-	-	-	-	-	-	65	-	-	50	-	-
Veh in Median Storage, #	-	0	-	-	0	-	-	0	-	-	0	-
Grade, %	-	0	-	-	0	-	-	0	-	-	0	-
Peak Hour Factor	94	94	94	94	94	94	94	94	94	94	94	94
Heavy Vehicles, %	0	0	0	0	0	0	0	2	0	0	1	0
Mvmt Flow	5	0	4	1	0	2	0	799	0	1	995	4

Major/Minor	Minor2			Minor1			Major1			Major2		
Conflicting Flow All	1804	1802	997	1804	1804	808	999	0	0	803	0	0
Stage 1	999	999	-	803	803	-	-	-	-	-	-	-
Stage 2	805	803	-	1001	1001	-	-	-	-	-	-	-
Critical Hdwy	7.1	6.5	6.2	7.1	6.5	6.2	4.1	-	-	4.1	-	-
Critical Hdwy Stg 1	6.1	5.5	-	6.1	5.5	-	-	-	-	-	-	-
Critical Hdwy Stg 2	6.1	5.5	-	6.1	5.5	-	-	-	-	-	-	-
Follow-up Hdwy	3.5	4	3.3	3.5	4	3.3	2.2	-	-	2.2	-	-
Pot Cap-1 Maneuver	62	80	299	62	80	384	701	-	-	830	-	-
Stage 1	296	324	-	380	399	-	-	-	-	-	-	-
Stage 2	379	399	-	295	323	-	-	-	-	-	-	-
Platoon blocked, %												
Mov Cap-1 Maneuver	61	80	299	61	80	381	701	-	-	826	-	-
Mov Cap-2 Maneuver	61	80	-	61	80	-	-	-	-	-	-	-
Stage 1	296	324	-	379	397	-	-	-	-	-	-	-
Stage 2	375	397	-	290	323	-	-	-	-	-	-	-

Approach	EB	WB	NB	SB
HCM Control Delay, s	47.6	31.5	0	0
HCM LOS	E	D		

Minor Lane/Major Mvmt	NBL	NBT	NBR	EBLn1WBLn1	SBL	SBT	SBR
Capacity (veh/h)	701	-	-	94	139	826	-
HCM Lane V/C Ratio	-	-	-	0.102	0.023	0.001	-
HCM Control Delay (s)	0	-	-	47.6	31.5	9.4	-
HCM Lane LOS	A	-	-	E	D	A	-
HCM 95th %tile Q(veh)	0	-	-	0.3	0.1	0	-

Intersection						
Int Delay, s/veh	0.6					
Movement	WBL	WBR	NBT	NBR	SBL	SBT
Lane Configurations	Y		P		T	T
Traffic Vol, veh/h	9	12	739	13	34	912
Future Vol, veh/h	9	12	739	13	34	912
Conflicting Peds, #/hr	0	0	0	2	2	0
Sign Control	Stop	Stop	Free	Free	Free	Free
RT Channelized	-	None	-	None	-	None
Storage Length	0	-	-	-	65	-
Veh in Median Storage, #	0	-	0	-	-	0
Grade, %	0	-	0	-	-	0
Peak Hour Factor	96	96	96	96	96	96
Heavy Vehicles, %	0	0	2	0	0	2
Mvmt Flow	9	13	770	14	35	950
Major/Minor	Minor1		Major1		Major2	
Conflicting Flow All	1800	779	0	0	785	0
Stage 1	779	-	-	-	-	-
Stage 2	1021	-	-	-	-	-
Critical Hdwy	6.4	6.2	-	-	4.1	-
Critical Hdwy Stg 1	5.4	-	-	-	-	-
Critical Hdwy Stg 2	5.4	-	-	-	-	-
Follow-up Hdwy	3.5	3.3	-	-	2.2	-
Pot Cap-1 Maneuver	89	399	-	-	843	-
Stage 1	456	-	-	-	-	-
Stage 2	351	-	-	-	-	-
Platoon blocked, %			-	-		
Mov Cap-1 Maneuver	85	398	-	-	843	-
Mov Cap-2 Maneuver	85	-	-	-	-	-
Stage 1	455	-	-	-	-	-
Stage 2	336	-	-	-	-	-
Approach	WB		NB		SB	
HCM Control Delay, s	32.2		0		0.3	
HCM LOS	D					
Minor Lane/Major Mvmt	NBT	NBRWBLn1	SBL	SBT		
Capacity (veh/h)	-	- 154	843	-		
HCM Lane V/C Ratio	-	- 0.142	0.042	-		
HCM Control Delay (s)	-	- 32.2	9.5	-		
HCM Lane LOS	-	- D	A	-		
HCM 95th %tile Q(veh)	-	- 0.5	0.1	-		

Intersection

Int Delay, s/veh 6.3

Movement	WBL	WBR	NBT	NBR	SBL	SBT
Lane Configurations	Y		P			A
Traffic Vol, veh/h	4	6	1	6	19	0
Future Vol, veh/h	4	6	1	6	19	0
Conflicting Peds, #/hr	1	0	0	5	5	0
Sign Control	Stop	Stop	Free	Free	Free	Free
RT Channelized	-	None	-	None	-	None
Storage Length	0	-	-	-	-	-
Veh in Median Storage, #	0	-	0	-	-	0
Grade, %	0	-	0	-	-	0
Peak Hour Factor	75	75	75	75	75	75
Heavy Vehicles, %	0	17	0	0	0	0
Mvmt Flow	5	8	1	8	25	0

Major/Minor	Minor1		Major1		Major2	
Conflicting Flow All	62	10	0	0	14	0
Stage 1	10	-	-	-	-	-
Stage 2	52	-	-	-	-	-
Critical Hdwy	6.4	6.37	-	-	4.1	-
Critical Hdwy Stg 1	5.4	-	-	-	-	-
Critical Hdwy Stg 2	5.4	-	-	-	-	-
Follow-up Hdwy	3.5	3.453	-	-	2.2	-
Pot Cap-1 Maneuver	949	1029	-	-	1617	-
Stage 1	1018	-	-	-	-	-
Stage 2	976	-	-	-	-	-
Platoon blocked, %			-	-		-
Mov Cap-1 Maneuver	929	1024	-	-	1617	-
Mov Cap-2 Maneuver	929	-	-	-	-	-
Stage 1	1013	-	-	-	-	-
Stage 2	960	-	-	-	-	-

Approach	WB		NB		SB
HCM Control Delay, s	8.7		0		7.3
HCM LOS	A				

Minor Lane/Major Mvmt	NBT	NBRWBLn1	SBL	SBT
Capacity (veh/h)	-	- 984	1617	-
HCM Lane V/C Ratio	-	- 0.014	0.016	-
HCM Control Delay (s)	-	- 8.7	7.3	0
HCM Lane LOS	-	- A	A	A
HCM 95th %tile Q(veh)	-	- 0	0	-

Intersection

Int Delay, s/veh 2

Movement	EBT	EBR	WBL	WBT	NBL	NBR
Lane Configurations	↔			↔	↔	
Traffic Vol, veh/h	8	16	1	4	7	0
Future Vol, veh/h	8	16	1	4	7	0
Conflicting Peds, #/hr	0	3	3	0	1	0
Sign Control	Free	Free	Free	Free	Stop	Stop
RT Channelized	-	None	-	None	-	None
Storage Length	-	-	-	-	0	-
Veh in Median Storage, #	0	-	-	0	0	-
Grade, %	0	-	-	0	0	-
Peak Hour Factor	69	69	69	69	69	69
Heavy Vehicles, %	0	0	0	0	29	0
Mvmt Flow	12	23	1	6	10	0

Major/Minor	Major1	Major2	Minor1
Conflicting Flow All	0	38	36
Stage 1	-	-	26
Stage 2	-	-	10
Critical Hdwy	-	4.1	7.39
Critical Hdwy Stg 1	-	-	6.39
Critical Hdwy Stg 2	-	-	6.39
Follow-up Hdwy	-	2.2	3.761
Pot Cap-1 Maneuver	-	1585	906
Stage 1	-	-	926
Stage 2	-	-	945
Platoon blocked, %	-	-	-
Mov Cap-1 Maneuver	-	1585	902
Mov Cap-2 Maneuver	-	-	902
Stage 1	-	-	926
Stage 2	-	-	943

Approach	EB	WB	NB
HCM Control Delay, s	0	1.5	9
HCM LOS			A

Minor Lane/Major Mvmt	NBLn1	EBT	EBR	WBL	WBT
Capacity (veh/h)	902	-	-	1585	-
HCM Lane V/C Ratio	0.011	-	-	0.001	-
HCM Control Delay (s)	9	-	-	7.3	0
HCM Lane LOS	A	-	-	A	A
HCM 95th %tile Q(veh)	0	-	-	0	-

Intersection

Int Delay, s/veh 1

Movement	EBL	EBT	EBR	WBL	WBT	WBR	NBL	NBT	NBR	SBL	SBT	SBR
Lane Configurations		↕			↕		↕	↕		↕	↕	
Traffic Vol, veh/h	7	0	7	7	0	17	10	729	7	28	882	5
Future Vol, veh/h	7	0	7	7	0	17	10	729	7	28	882	5
Conflicting Peds, #/hr	0	0	0	0	0	0	0	0	2	2	0	0
Sign Control	Stop	Stop	Stop	Stop	Stop	Stop	Free	Free	Free	Free	Free	Free
RT Channelized	-	-	None	-	-	None	-	-	None	-	-	None
Storage Length	-	-	-	-	-	-	125	-	-	125	-	-
Veh in Median Storage, #	-	0	-	-	0	-	-	0	-	-	0	-
Grade, %	-	0	-	-	0	-	-	0	-	-	0	-
Peak Hour Factor	96	96	96	96	96	96	96	96	96	96	96	96
Heavy Vehicles, %	0	0	0	0	0	0	0	2	14	7	2	0
Mvmt Flow	7	0	7	7	0	18	10	759	7	29	919	5

Major/Minor	Minor2			Minor1			Major1			Major2		
Conflicting Flow All	1773	1770	921	1769	1768	765	924	0	0	769	0	0
Stage 1	980	980	-	786	786	-	-	-	-	-	-	-
Stage 2	793	790	-	983	982	-	-	-	-	-	-	-
Critical Hdwy	7.1	6.5	6.2	7.1	6.5	6.2	4.1	-	-	4.17	-	-
Critical Hdwy Stg 1	6.1	5.5	-	6.1	5.5	-	-	-	-	-	-	-
Critical Hdwy Stg 2	6.1	5.5	-	6.1	5.5	-	-	-	-	-	-	-
Follow-up Hdwy	3.5	4	3.3	3.5	4	3.3	2.2	-	-	2.263	-	-
Pot Cap-1 Maneuver	65	84	331	66	84	406	748	-	-	823	-	-
Stage 1	303	331	-	388	406	-	-	-	-	-	-	-
Stage 2	385	404	-	302	330	-	-	-	-	-	-	-
Platoon blocked, %												
Mov Cap-1 Maneuver	60	80	331	62	80	405	748	-	-	823	-	-
Mov Cap-2 Maneuver	60	80	-	62	80	-	-	-	-	-	-	-
Stage 1	299	319	-	382	400	-	-	-	-	-	-	-
Stage 2	363	398	-	285	318	-	-	-	-	-	-	-

Approach	EB	WB	NB	SB
HCM Control Delay, s	46.1	32.6	0.1	0.3
HCM LOS	E	D		

Minor Lane/Major Mvmt	NBL	NBT	NBR	EBLn1WBLn1	SBL	SBT	SBR
Capacity (veh/h)	748	-	-	102	155	823	-
HCM Lane V/C Ratio	0.014	-	-	0.143	0.161	0.035	-
HCM Control Delay (s)	9.9	-	-	46.1	32.6	9.5	-
HCM Lane LOS	A	-	-	E	D	A	-
HCM 95th %tile Q(veh)	0	-	-	0.5	0.6	0.1	-

Intersection

Int Delay, s/veh 3.5

Movement	EBL	EBT	EBR	WBL	WBT	WBR	NBL	NBT	NBR	SBL	SBT	SBR
Lane Configurations		↔			↔		↔	↔		↔	↔	
Traffic Vol, veh/h	3	0	3	32	0	13	5	734	42	17	876	10
Future Vol, veh/h	3	0	3	32	0	13	5	734	42	17	876	10
Conflicting Peds, #/hr	1	0	0	0	0	1	1	0	0	0	0	1
Sign Control	Stop	Stop	Stop	Stop	Stop	Stop	Free	Free	Free	Free	Free	Free
RT Channelized	-	-	None	-	-	None	-	-	None	-	-	None
Storage Length	-	-	-	-	-	-	80	-	-	125	-	-
Veh in Median Storage, #	-	0	-	-	0	-	-	0	-	-	0	-
Grade, %	-	0	-	-	0	-	-	0	-	-	0	-
Peak Hour Factor	91	91	91	91	91	91	91	91	91	91	91	91
Heavy Vehicles, %	2	2	2	2	2	2	2	2	2	2	2	2
Mvmt Flow	3	0	3	35	0	14	5	807	46	19	963	11

Major/Minor	Minor2			Minor1			Major1			Major2		
Conflicting Flow All	1855	1870	969	1848	1853	831	975	0	0	853	0	0
Stage 1	1006	1006	-	841	841	-	-	-	-	-	-	-
Stage 2	849	864	-	1007	1012	-	-	-	-	-	-	-
Critical Hdwy	7.12	6.52	6.22	7.12	6.52	6.22	4.12	-	-	4.12	-	-
Critical Hdwy Stg 1	6.12	5.52	-	6.12	5.52	-	-	-	-	-	-	-
Critical Hdwy Stg 2	6.12	5.52	-	6.12	5.52	-	-	-	-	-	-	-
Follow-up Hdwy	3.518	4.018	3.318	3.518	4.018	3.318	2.218	-	-	2.218	-	-
Pot Cap-1 Maneuver	57	72	308	57	74	370	707	-	-	786	-	-
Stage 1	291	319	-	359	380	-	-	-	-	-	-	-
Stage 2	356	371	-	290	317	-	-	-	-	-	-	-
Platoon blocked, %												
Mov Cap-1 Maneuver	53	70	308	55	72	370	707	-	-	785	-	-
Mov Cap-2 Maneuver	53	70	-	55	72	-	-	-	-	-	-	-
Stage 1	289	311	-	356	377	-	-	-	-	-	-	-
Stage 2	340	368	-	280	309	-	-	-	-	-	-	-

Approach	EB	WB	NB	SB
HCM Control Delay, s	48.1	124.2	0.1	0.2
HCM LOS	E	F		

Minor Lane/Major Mvmt	NBL	NBT	NBR	EBLn1	WBLn1	SBL	SBT	SBR
Capacity (veh/h)	707	-	-	90	73	785	-	-
HCM Lane V/C Ratio	0.008	-	-	0.073	0.677	0.024	-	-
HCM Control Delay (s)	10.1	-	-	48.1	124.2	9.7	-	-
HCM Lane LOS	B	-	-	E	F	A	-	-
HCM 95th %tile Q(veh)	0	-	-	0.2	3.1	0.1	-	-

Intersection

Int Delay, s/veh 3.9

Movement	EBL	EBT	EBR	WBL	WBT	WBR	NBL	NBT	NBR	SBL	SBT	SBR
Lane Configurations		↕			↕			↕			↕	
Traffic Vol, veh/h	13	35	2	0	34	4	9	7	6	3	8	12
Future Vol, veh/h	13	35	2	0	34	4	9	7	6	3	8	12
Conflicting Peds, #/hr	2	0	1	1	0	2	0	0	0	0	0	0
Sign Control	Free	Free	Free	Free	Free	Free	Stop	Stop	Stop	Stop	Stop	Stop
RT Channelized	-	-	None	-	-	None	-	-	None	-	-	None
Storage Length	-	-	-	-	-	-	-	-	-	-	-	-
Veh in Median Storage, #	-	0	-	-	0	-	-	0	-	-	0	-
Grade, %	-	0	-	-	0	-	-	0	-	-	0	-
Peak Hour Factor	79	79	79	79	79	79	79	79	79	79	79	79
Heavy Vehicles, %	0	3	0	0	0	0	0	0	0	33	0	0
Mvmt Flow	16	44	3	0	43	5	11	9	8	4	10	15

Major/Minor	Major1			Major2			Minor1			Minor2		
Conflicting Flow All	50	0	0	48	0	0	137	129	47	135	129	48
Stage 1	-	-	-	-	-	-	79	79	-	48	48	-
Stage 2	-	-	-	-	-	-	58	50	-	87	81	-
Critical Hdwy	4.1	-	-	4.1	-	-	7.1	6.5	6.2	7.43	6.5	6.2
Critical Hdwy Stg 1	-	-	-	-	-	-	6.1	5.5	-	6.43	5.5	-
Critical Hdwy Stg 2	-	-	-	-	-	-	6.1	5.5	-	6.43	5.5	-
Follow-up Hdwy	2.2	-	-	2.2	-	-	3.5	4	3.3	3.797	4	3.3
Pot Cap-1 Maneuver	1570	-	-	1572	-	-	838	765	1028	770	765	1027
Stage 1	-	-	-	-	-	-	935	833	-	892	859	-
Stage 2	-	-	-	-	-	-	959	857	-	849	832	-
Platoon blocked, %	-	-	-	-	-	-	-	-	-	-	-	-
Mov Cap-1 Maneuver	1570	-	-	1572	-	-	810	755	1027	750	755	1025
Mov Cap-2 Maneuver	-	-	-	-	-	-	810	755	-	750	755	-
Stage 1	-	-	-	-	-	-	925	824	-	881	857	-
Stage 2	-	-	-	-	-	-	934	855	-	825	823	-

Approach	EB	WB	NB	SB
HCM Control Delay, s	1.9	0	9.4	9.3
HCM LOS			A	A

Minor Lane/Major Mvmt	NBLn1	EBL	EBT	EBR	WBL	WBT	WBR	SBLn1
Capacity (veh/h)	839	1570	-	-	1572	-	-	874
HCM Lane V/C Ratio	0.033	0.01	-	-	-	-	-	0.033
HCM Control Delay (s)	9.4	7.3	0	-	0	-	-	9.3
HCM Lane LOS	A	A	A	-	A	-	-	A
HCM 95th %tile Q(veh)	0.1	0	-	-	0	-	-	0.1

Intersection

Int Delay, s/veh 7.5

Movement	EBL	EBT	EBR	WBL	WBT	WBR	NBL	NBT	NBR	SBL	SBT	SBR
Lane Configurations		↕			↕			↕			↕	
Traffic Vol, veh/h	0	39	3	9	33	2	4	6	5	15	12	2
Future Vol, veh/h	0	39	3	9	33	2	4	6	5	15	12	2
Conflicting Peds, #/hr	3	0	0	0	0	3	3	0	2	2	0	3
Sign Control	Stop	Stop	Stop	Stop	Stop	Stop	Free	Free	Free	Free	Free	Free
RT Channelized	-	-	None	-	-	None	-	-	None	-	-	None
Storage Length	-	-	-	-	-	-	-	-	-	-	-	-
Veh in Median Storage, #	-	0	-	-	0	-	-	0	-	-	0	-
Grade, %	-	0	-	-	0	-	-	0	-	-	0	-
Peak Hour Factor	86	86	86	86	86	86	86	86	86	86	86	86
Heavy Vehicles, %	0	5	0	22	0	0	0	0	0	0	8	0
Mvmt Flow	0	45	3	10	38	2	5	7	6	17	14	2

Major/Minor	Minor2			Minor1			Major1			Major2		
Conflicting Flow All	96	77	18	95	75	15	19	0	0	15	0	0
Stage 1	53	53	-	21	21	-	-	-	-	-	-	-
Stage 2	43	24	-	74	54	-	-	-	-	-	-	-
Critical Hdwy	7.1	6.55	6.2	7.32	6.5	6.2	4.1	-	-	4.1	-	-
Critical Hdwy Stg 1	6.1	5.55	-	6.32	5.5	-	-	-	-	-	-	-
Critical Hdwy Stg 2	6.1	5.55	-	6.32	5.5	-	-	-	-	-	-	-
Follow-up Hdwy	3.5	4.045	3.3	3.698	4	3.3	2.2	-	-	2.2	-	-
Pot Cap-1 Maneuver	891	808	1066	842	819	1070	1611	-	-	1616	-	-
Stage 1	965	845	-	948	882	-	-	-	-	-	-	-
Stage 2	976	869	-	888	854	-	-	-	-	-	-	-
Platoon blocked, %												
Mov Cap-1 Maneuver	843	793	1063	793	804	1065	1611	-	-	1611	-	-
Mov Cap-2 Maneuver	843	793	-	793	804	-	-	-	-	-	-	-
Stage 1	959	833	-	943	878	-	-	-	-	-	-	-
Stage 2	926	865	-	828	842	-	-	-	-	-	-	-

Approach	EB	WB	NB	SB
HCM Control Delay, s	9.7	9.7	1.9	3.8
HCM LOS	A	A		

Minor Lane/Major Mvmt	NBL	NBT	NBR	EBLn1WBLn1	SBL	SBT	SBR
Capacity (veh/h)	1611	-	-	808	811	1611	-
HCM Lane V/C Ratio	0.003	-	-	0.06	0.063	0.011	-
HCM Control Delay (s)	7.2	0	-	9.7	9.7	7.3	0
HCM Lane LOS	A	A	-	A	A	A	A
HCM 95th %tile Q(veh)	0	-	-	0.2	0.2	0	-

Intersection	
Intersection Delay, s/veh	7.3
Intersection LOS	A

Movement	EBU	EBL	EBT	EBR	WBU	WBL	WBT	WBR	NBU	NBL	NBT	NBR
Lane Configurations			↕				↕				↕	
Traffic Vol, veh/h	0	2	53	6	0	1	32	0	0	5	2	3
Future Vol, veh/h	0	2	53	6	0	1	32	0	0	5	2	3
Peak Hour Factor	0.92	0.75	0.75	0.75	0.92	0.75	0.75	0.75	0.92	0.75	0.75	0.75
Heavy Vehicles, %	2	0	4	0	2	0	0	0	2	40	0	0
Mvmt Flow	0	3	71	8	0	1	43	0	0	7	3	4
Number of Lanes	0	0	1	0	0	0	1	0	0	0	1	0

Approach	EB	WB	NB
Opposing Approach	WB	EB	SB
Opposing Lanes	1	1	1
Conflicting Approach Left	SB	NB	EB
Conflicting Lanes Left	1	1	1
Conflicting Approach Right	NB	SB	WB
Conflicting Lanes Right	1	1	1
HCM Control Delay	7.3	7.2	7.9
HCM LOS	A	A	A

Lane	NBLn1	EBLn1	WBLn1	SBLn1
Vol Left, %	50%	3%	3%	0%
Vol Thru, %	20%	87%	97%	0%
Vol Right, %	30%	10%	0%	100%
Sign Control	Stop	Stop	Stop	Stop
Traffic Vol by Lane	10	61	33	4
LT Vol	5	2	1	0
Through Vol	2	53	32	0
RT Vol	3	6	0	4
Lane Flow Rate	13	81	44	5
Geometry Grp	1	1	1	1
Degree of Util (X)	0.017	0.088	0.049	0.005
Departure Headway (Hd)	4.721	3.914	4	3.525
Convergence, Y/N	Yes	Yes	Yes	Yes
Cap	755	917	895	1006
Service Time	2.771	1.932	2.023	1.579
HCM Lane V/C Ratio	0.017	0.088	0.049	0.005
HCM Control Delay	7.9	7.3	7.2	6.6
HCM Lane LOS	A	A	A	A
HCM 95th-tile Q	0.1	0.3	0.2	0

Intersection

Intersection Delay, s/veh
 Intersection LOS

Movement	SBU	SBL	SBT	SBR
Lane Configurations			↕	
Traffic Vol, veh/h	0	0	0	4
Future Vol, veh/h	0	0	0	4
Peak Hour Factor	0.92	0.75	0.75	0.75
Heavy Vehicles, %	2	0	0	0
Mvmt Flow	0	0	0	5
Number of Lanes	0	0	1	0

Approach SB

Opposing Approach	NB
Opposing Lanes	1
Conflicting Approach Left	WB
Conflicting Lanes Left	1
Conflicting Approach Right	EB
Conflicting Lanes Right	1
HCM Control Delay	6.6
HCM LOS	A

Intersection

Int Delay, s/veh 0.1

Movement	EBL	EBR	NBL	NBT	SBT	SBR
Lane Configurations	Y			Y	Y	
Traffic Vol, veh/h	1	2	8	765	905	1
Future Vol, veh/h	1	2	8	765	905	1
Conflicting Peds, #/hr	0	0	0	0	0	0
Sign Control	Stop	Stop	Free	Free	Free	Free
RT Channelized	-	None	-	None	-	None
Storage Length	0	-	-	-	-	-
Veh in Median Storage, #	0	-	-	0	0	-
Grade, %	0	-	-	0	0	-
Peak Hour Factor	91	91	91	91	91	92
Heavy Vehicles, %	2	2	2	2	2	2
Mvmt Flow	1	2	9	841	995	1

Major/Minor	Minor2		Major1		Major2	
Conflicting Flow All	1853	995	996	0	-	0
Stage 1	995	-	-	-	-	-
Stage 2	858	-	-	-	-	-
Critical Hdwy	6.42	6.22	4.12	-	-	-
Critical Hdwy Stg 1	5.42	-	-	-	-	-
Critical Hdwy Stg 2	5.42	-	-	-	-	-
Follow-up Hdwy	3.518	3.318	2.218	-	-	-
Pot Cap-1 Maneuver	81	297	695	-	-	-
Stage 1	358	-	-	-	-	-
Stage 2	415	-	-	-	-	-
Platoon blocked, %				-	-	-
Mov Cap-1 Maneuver	79	297	695	-	-	-
Mov Cap-2 Maneuver	79	-	-	-	-	-
Stage 1	358	-	-	-	-	-
Stage 2	405	-	-	-	-	-

Approach	EB	NB	SB
HCM Control Delay, s	28.7	0.1	0
HCM LOS	D		

Minor Lane/Major Mvmt	NBL	NBT	EBLn1	SBT	SBR
Capacity (veh/h)	695	-	155	-	-
HCM Lane V/C Ratio	0.013	-	0.021	-	-
HCM Control Delay (s)	10.2	0	28.7	-	-
HCM Lane LOS	B	A	D	-	-
HCM 95th %tile Q(veh)	0	-	0.1	-	-

Intersection

Int Delay, s/veh 0.3

Movement	WBL	WBR	NBT	NBR	SBL	SBT
Lane Configurations	↕		↑	↗		↖
Traffic Vol, veh/h	7	3	764	9	4	983
Future Vol, veh/h	7	3	764	9	4	983
Conflicting Peds, #/hr	0	0	0	1	1	0
Sign Control	Stop	Stop	Free	Free	Free	Free
RT Channelized	-	None	-	None	-	None
Storage Length	0	-	-	125	-	-
Veh in Median Storage, #	0	-	0	-	-	0
Grade, %	0	-	0	-	-	0
Peak Hour Factor	96	96	96	96	96	96
Heavy Vehicles, %	0	0	2	0	0	1
Mvmt Flow	7	3	796	9	4	1024

Major/Minor	Minor1		Major1		Major2	
Conflicting Flow All	1829	797	0	0	797	0
Stage 1	797	-	-	-	-	-
Stage 2	1032	-	-	-	-	-
Critical Hdwy	7.1	6.2	-	-	4.1	-
Critical Hdwy Stg 1	6.1	-	-	-	-	-
Critical Hdwy Stg 2	6.1	-	-	-	-	-
Follow-up Hdwy	3.5	3.3	-	-	2.2	-
Pot Cap-1 Maneuver	60	390	-	-	834	-
Stage 1	383	-	-	-	-	-
Stage 2	284	-	-	-	-	-
Platoon blocked, %			-	-		
Mov Cap-1 Maneuver	59	390	-	-	834	-
Mov Cap-2 Maneuver	59	-	-	-	-	-
Stage 1	383	-	-	-	-	-
Stage 2	281	-	-	-	-	-

Approach	WB		NB		SB
HCM Control Delay, s	57.4		0		0
HCM LOS	F				

Minor Lane/Major Mvmt	NBT	NBRWBLn1	SBL	SBT
Capacity (veh/h)	-	-	79	834
HCM Lane V/C Ratio	-	-	0.132	0.005
HCM Control Delay (s)	-	-	57.4	9.3
HCM Lane LOS	-	-	F	A
HCM 95th %tile Q(veh)	-	-	0.4	0

Intersection

Int Delay, s/veh 0

Movement	EBL	EBT	EBR	WBL	WBT	WBR	NBL	NBT	NBR	SBL	SBT	SBR
Lane Configurations		↕			↕		↕	↕		↕	↕	
Traffic Vol, veh/h	0	0	0	1	0	1	2	763	0	1	992	4
Future Vol, veh/h	0	0	0	1	0	1	2	763	0	1	992	4
Conflicting Peds, #/hr	0	0	1	1	0	0	0	0	3	3	0	0
Sign Control	Stop	Stop	Stop	Stop	Stop	Stop	Free	Free	Free	Free	Free	Free
RT Channelized	-	-	None	-	-	None	-	-	None	-	-	None
Storage Length	-	-	-	-	-	-	65	-	-	50	-	-
Veh in Median Storage, #	-	0	-	-	0	-	-	0	-	-	0	-
Grade, %	-	0	-	-	0	-	-	0	-	-	0	-
Peak Hour Factor	96	96	96	96	96	96	96	96	96	96	96	96
Heavy Vehicles, %	0	0	0	0	0	0	0	3	0	0	2	0
Mvmt Flow	0	0	0	1	0	1	2	795	0	1	1033	4

Major/Minor	Minor2			Minor1			Major1			Major2		
Conflicting Flow All	1837	1840	1036	1841	1842	798	1038	0	0	798	0	0
Stage 1	1038	1038	-	802	802	-	-	-	-	-	-	-
Stage 2	799	802	-	1039	1040	-	-	-	-	-	-	-
Critical Hdwy	7.1	6.5	6.2	7.1	6.5	6.2	4.1	-	-	4.1	-	-
Critical Hdwy Stg 1	6.1	5.5	-	6.1	5.5	-	-	-	-	-	-	-
Critical Hdwy Stg 2	6.1	5.5	-	6.1	5.5	-	-	-	-	-	-	-
Follow-up Hdwy	3.5	4	3.3	3.5	4	3.3	2.2	-	-	2.2	-	-
Pot Cap-1 Maneuver	59	76	284	59	76	389	678	-	-	833	-	-
Stage 1	281	311	-	381	399	-	-	-	-	-	-	-
Stage 2	382	399	-	281	310	-	-	-	-	-	-	-
Platoon blocked, %												
Mov Cap-1 Maneuver	59	75	284	59	75	388	677	-	-	833	-	-
Mov Cap-2 Maneuver	59	75	-	59	75	-	-	-	-	-	-	-
Stage 1	280	311	-	379	397	-	-	-	-	-	-	-
Stage 2	380	397	-	280	310	-	-	-	-	-	-	-

Approach	EB	WB	NB	SB
HCM Control Delay, s	0	41	0	0
HCM LOS	A	E		

Minor Lane/Major Mvmt	NBL	NBT	NBR	EBLn1	WBLn1	SBL	SBT	SBR
Capacity (veh/h)	677	-	-	-	102	833	-	-
HCM Lane V/C Ratio	0.003	-	-	-	0.02	0.001	-	-
HCM Control Delay (s)	10.3	-	-	0	41	9.3	-	-
HCM Lane LOS	B	-	-	A	E	A	-	-
HCM 95th %tile Q(veh)	0	-	-	-	0.1	0	-	-

Intersection

Int Delay, s/veh 0.7

Movement	WBL	WBR	NBT	NBR	SBL	SBT
Lane Configurations	Y		P		T	T
Traffic Vol, veh/h	10	19	749	8	19	973
Future Vol, veh/h	10	19	749	8	19	973
Conflicting Peds, #/hr	0	0	0	1	1	0
Sign Control	Stop	Stop	Free	Free	Free	Free
RT Channelized	-	None	-	None	-	None
Storage Length	0	-	-	-	65	-
Veh in Median Storage, #	0	-	0	-	-	0
Grade, %	0	-	0	-	-	0
Peak Hour Factor	93	93	93	93	93	93
Heavy Vehicles, %	0	9	2	0	0	1
Mvmt Flow	11	20	805	9	20	1046

Major/Minor	Minor1		Major1		Major2	
Conflicting Flow All	1898	811	0	0	815	0
Stage 1	811	-	-	-	-	-
Stage 2	1087	-	-	-	-	-
Critical Hdwy	6.4	6.29	-	-	4.1	-
Critical Hdwy Stg 1	5.4	-	-	-	-	-
Critical Hdwy Stg 2	5.4	-	-	-	-	-
Follow-up Hdwy	3.5	3.381	-	-	2.2	-
Pot Cap-1 Maneuver	77	369	-	-	821	-
Stage 1	440	-	-	-	-	-
Stage 2	326	-	-	-	-	-
Platoon blocked, %			-	-		
Mov Cap-1 Maneuver	75	369	-	-	821	-
Mov Cap-2 Maneuver	75	-	-	-	-	-
Stage 1	440	-	-	-	-	-
Stage 2	318	-	-	-	-	-

Approach	WB		NB		SB
HCM Control Delay, s	33.5		0		0.2
HCM LOS	D				

Minor Lane/Major Mvmt	NBT	NBRWBLn1	SBL	SBT
Capacity (veh/h)	-	- 157	821	-
HCM Lane V/C Ratio	-	- 0.199	0.025	-
HCM Control Delay (s)	-	- 33.5	9.5	-
HCM Lane LOS	-	- D	A	-
HCM 95th %tile Q(veh)	-	- 0.7	0.1	-

Intersection

Int Delay, s/veh 6.7

Movement	WBL	WBR	NBT	NBR	SBL	SBT
Lane Configurations	Y		P			A
Traffic Vol, veh/h	3	13	1	2	6	2
Future Vol, veh/h	3	13	1	2	6	2
Conflicting Peds, #/hr	2	0	0	0	0	0
Sign Control	Stop	Stop	Free	Free	Free	Free
RT Channelized	-	None	-	None	-	None
Storage Length	0	-	-	-	-	-
Veh in Median Storage, #	0	-	0	-	-	0
Grade, %	0	-	0	-	-	0
Peak Hour Factor	75	75	75	75	75	75
Heavy Vehicles, %	33	8	0	0	0	0
Mvmt Flow	4	17	1	3	8	3

Major/Minor	Minor1		Major1		Major2	
Conflicting Flow All	24	3	0	0	4	0
Stage 1	3	-	-	-	-	-
Stage 2	21	-	-	-	-	-
Critical Hdwy	6.73	6.28	-	-	4.1	-
Critical Hdwy Stg 1	5.73	-	-	-	-	-
Critical Hdwy Stg 2	5.73	-	-	-	-	-
Follow-up Hdwy	3.797	3.372	-	-	2.2	-
Pot Cap-1 Maneuver	918	1064	-	-	1631	-
Stage 1	945	-	-	-	-	-
Stage 2	927	-	-	-	-	-
Platoon blocked, %			-	-		-
Mov Cap-1 Maneuver	912	1064	-	-	1631	-
Mov Cap-2 Maneuver	912	-	-	-	-	-
Stage 1	945	-	-	-	-	-
Stage 2	921	-	-	-	-	-

Approach	WB		NB		SB
HCM Control Delay, s	8.6		0		5.4
HCM LOS	A				

Minor Lane/Major Mvmt	NBT	NBRWBLn1	SBL	SBT
Capacity (veh/h)	-	- 1032	1631	-
HCM Lane V/C Ratio	-	- 0.021	0.005	-
HCM Control Delay (s)	-	- 8.6	7.2	0
HCM Lane LOS	-	- A	A	A
HCM 95th %tile Q(veh)	-	- 0.1	0	-

Intersection

Int Delay, s/veh 5.9

Movement	EBT	EBR	WBL	WBT	NBL	NBR
Lane Configurations	↔			↔	↔	
Traffic Vol, veh/h	2	5	1	0	13	1
Future Vol, veh/h	2	5	1	0	13	1
Conflicting Peds, #/hr	0	1	1	0	0	0
Sign Control	Free	Free	Free	Free	Stop	Stop
RT Channelized	-	None	-	None	-	None
Storage Length	-	-	-	-	0	-
Veh in Median Storage, #	0	-	-	0	0	-
Grade, %	0	-	-	0	0	-
Peak Hour Factor	79	79	79	79	79	79
Heavy Vehicles, %	0	0	100	0	15	0
Mvmt Flow	3	6	1	0	16	1

Major/Minor	Major1	Major2	Minor1	Minor2
Conflicting Flow All	0	0	10	0
Stage 1	-	-	-	-
Stage 2	-	-	-	-
Critical Hdwy	-	-	5.1	-
Critical Hdwy Stg 1	-	-	-	-
Critical Hdwy Stg 2	-	-	-	-
Follow-up Hdwy	-	-	3.1	-
Pot Cap-1 Maneuver	-	-	1150	-
Stage 1	-	-	-	-
Stage 2	-	-	-	-
Platoon blocked, %	-	-	-	-
Mov Cap-1 Maneuver	-	-	1150	-
Mov Cap-2 Maneuver	-	-	-	-
Stage 1	-	-	-	-
Stage 2	-	-	-	-

Approach	EB	WB	NB
HCM Control Delay, s	0	8.1	8.7
HCM LOS			A

Minor Lane/Major Mvmt	NBLn1	EBT	EBR	WBL	WBT
Capacity (veh/h)	982	-	-	1150	-
HCM Lane V/C Ratio	0.018	-	-	0.001	-
HCM Control Delay (s)	8.7	-	-	8.1	0
HCM Lane LOS	A	-	-	A	A
HCM 95th %tile Q(veh)	0.1	-	-	0	-

Intersection

Int Delay, s/veh 0.8

Movement	EBL	EBT	EBR	WBL	WBT	WBR	NBL	NBT	NBR	SBL	SBT	SBR
Lane Configurations		↕			↕		↕	↕		↕	↕	
Traffic Vol, veh/h	0	0	6	6	1	25	9	736	2	22	953	5
Future Vol, veh/h	0	0	6	6	1	25	9	736	2	22	953	5
Conflicting Peds, #/hr	0	0	0	0	0	0	0	0	1	1	0	0
Sign Control	Stop	Stop	Stop	Stop	Stop	Stop	Free	Free	Free	Free	Free	Free
RT Channelized	-	-	None	-	-	None	-	-	None	-	-	None
Storage Length	-	-	-	-	-	-	125	-	-	125	-	-
Veh in Median Storage, #	-	0	-	-	0	-	-	0	-	-	0	-
Grade, %	-	0	-	-	0	-	-	0	-	-	0	-
Peak Hour Factor	95	95	95	95	95	95	95	95	95	95	95	95
Heavy Vehicles, %	0	0	0	17	0	4	0	3	0	5	1	0
Mvmt Flow	0	0	6	6	1	26	9	775	2	23	1003	5

Major/Minor	Minor2			Minor1			Major1			Major2		
Conflicting Flow All	1860	1849	1006	1851	1851	777	1008	0	0	778	0	0
Stage 1	1052	1052	-	796	796	-	-	-	-	-	-	-
Stage 2	808	797	-	1055	1055	-	-	-	-	-	-	-
Critical Hdwy	7.1	6.5	6.2	7.27	6.5	6.24	4.1	-	-	4.15	-	-
Critical Hdwy Stg 1	6.1	5.5	-	6.27	5.5	-	-	-	-	-	-	-
Critical Hdwy Stg 2	6.1	5.5	-	6.27	5.5	-	-	-	-	-	-	-
Follow-up Hdwy	3.5	4	3.3	3.653	4	3.336	2.2	-	-	2.245	-	-
Pot Cap-1 Maneuver	57	75	295	52	75	394	695	-	-	825	-	-
Stage 1	276	306	-	359	402	-	-	-	-	-	-	-
Stage 2	378	401	-	256	305	-	-	-	-	-	-	-
Platoon blocked, %												
Mov Cap-1 Maneuver	51	72	295	49	72	394	695	-	-	825	-	-
Mov Cap-2 Maneuver	51	72	-	49	72	-	-	-	-	-	-	-
Stage 1	272	297	-	354	396	-	-	-	-	-	-	-
Stage 2	347	395	-	244	296	-	-	-	-	-	-	-

Approach	EB	WB	NB	SB
HCM Control Delay, s	17.5	33.4	0.1	0.2
HCM LOS	C	D		

Minor Lane/Major Mvmt	NBL	NBT	NBR	EBLn1	WBLn1	SBL	SBT	SBR
Capacity (veh/h)	695	-	-	295	160	825	-	-
HCM Lane V/C Ratio	0.014	-	-	0.021	0.211	0.028	-	-
HCM Control Delay (s)	10.3	-	-	17.5	33.4	9.5	-	-
HCM Lane LOS	B	-	-	C	D	A	-	-
HCM 95th %tile Q(veh)	0	-	-	0.1	0.8	0.1	-	-

Intersection

Int Delay, s/veh 3.7

Movement	EBL	EBT	EBR	WBL	WBT	WBR	NBL	NBT	NBR	SBL	SBT	SBR
Lane Configurations		↔			↔		↔	↔		↔	↔	
Traffic Vol, veh/h	6	3	21	23	3	23	28	720	36	7	953	7
Future Vol, veh/h	6	3	21	23	3	23	28	720	36	7	953	7
Conflicting Peds, #/hr	1	0	0	0	0	1	0	0	0	0	0	0
Sign Control	Stop	Stop	Stop	Stop	Stop	Stop	Free	Free	Free	Free	Free	Free
RT Channelized	-	-	None	-	-	None	-	-	None	-	-	None
Storage Length	-	-	-	-	-	-	80	-	-	125	-	-
Veh in Median Storage, #	-	0	-	-	0	-	-	0	-	-	0	-
Grade, %	-	0	-	-	0	-	-	0	-	-	0	-
Peak Hour Factor	95	95	95	95	95	95	95	95	95	95	95	95
Heavy Vehicles, %	2	2	2	2	2	2	2	2	2	2	2	2
Mvmt Flow	6	3	22	24	3	24	29	758	38	7	1003	7

Major/Minor	Minor2			Minor1			Major1			Major2		
Conflicting Flow All	1872	1877	1007	1870	1861	778	1011	0	0	796	0	0
Stage 1	1022	1022	-	836	836	-	-	-	-	-	-	-
Stage 2	850	855	-	1034	1025	-	-	-	-	-	-	-
Critical Hdwy	7.12	6.52	6.22	7.12	6.52	6.22	4.12	-	-	4.12	-	-
Critical Hdwy Stg 1	6.12	5.52	-	6.12	5.52	-	-	-	-	-	-	-
Critical Hdwy Stg 2	6.12	5.52	-	6.12	5.52	-	-	-	-	-	-	-
Follow-up Hdwy	3.518	4.018	3.318	3.518	4.018	3.318	2.218	-	-	2.218	-	-
Pot Cap-1 Maneuver	55	71	292	55	73	396	686	-	-	826	-	-
Stage 1	285	313	-	362	382	-	-	-	-	-	-	-
Stage 2	355	375	-	280	312	-	-	-	-	-	-	-
Platoon blocked, %												
Mov Cap-1 Maneuver	48	67	292	47	69	396	686	-	-	825	-	-
Mov Cap-2 Maneuver	48	67	-	47	69	-	-	-	-	-	-	-
Stage 1	273	310	-	347	366	-	-	-	-	-	-	-
Stage 2	316	359	-	254	309	-	-	-	-	-	-	-

Approach	EB	WB	NB	SB
HCM Control Delay, s	43.7	102.4	0.4	0.1
HCM LOS	E	F		

Minor Lane/Major Mvmt	NBL	NBT	NBR	EBLn1	WBLn1	SBL	SBT	SBR
Capacity (veh/h)	686	-	-	124	83	825	-	-
HCM Lane V/C Ratio	0.043	-	-	0.255	0.621	0.009	-	-
HCM Control Delay (s)	10.5	-	-	43.7	102.4	9.4	-	-
HCM Lane LOS	B	-	-	E	F	A	-	-
HCM 95th %tile Q(veh)	0.1	-	-	0.9	2.9	0	-	-

Intersection

Int Delay, s/veh 4.5

Movement	EBL	EBT	EBR	WBL	WBT	WBR	NBL	NBT	NBR	SBL	SBT	SBR
Lane Configurations		↕			↕			↕			↕	
Traffic Vol, veh/h	25	33	2	5	31	17	10	9	3	6	17	8
Future Vol, veh/h	25	33	2	5	31	17	10	9	3	6	17	8
Conflicting Peds, #/hr	1	0	0	0	0	1	0	0	2	2	0	0
Sign Control	Free	Free	Free	Free	Free	Free	Stop	Stop	Stop	Stop	Stop	Stop
RT Channelized	-	-	None	-	-	None	-	-	None	-	-	None
Storage Length	-	-	-	-	-	-	-	-	-	-	-	-
Veh in Median Storage, #	-	0	-	-	0	-	-	0	-	-	0	-
Grade, %	-	0	-	-	0	-	-	0	-	-	0	-
Peak Hour Factor	83	83	83	83	83	83	83	83	83	83	83	83
Heavy Vehicles, %	0	0	0	0	0	0	0	0	0	0	0	0
Mvmt Flow	30	40	2	6	37	20	12	11	4	7	20	10

Major/Minor	Major1	Major2	Minor1	Minor2								
Conflicting Flow All	59	0	0	42	0	0	176	172	43	171	163	49
Stage 1	-	-	-	-	-	-	101	101	-	61	61	-
Stage 2	-	-	-	-	-	-	75	71	-	110	102	-
Critical Hdwy	4.1	-	-	4.1	-	-	7.1	6.5	6.2	7.1	6.5	6.2
Critical Hdwy Stg 1	-	-	-	-	-	-	6.1	5.5	-	6.1	5.5	-
Critical Hdwy Stg 2	-	-	-	-	-	-	6.1	5.5	-	6.1	5.5	-
Follow-up Hdwy	2.2	-	-	2.2	-	-	3.5	4	3.3	3.5	4	3.3
Pot Cap-1 Maneuver	1558	-	-	1580	-	-	791	725	1033	797	733	1025
Stage 1	-	-	-	-	-	-	910	815	-	955	848	-
Stage 2	-	-	-	-	-	-	939	840	-	900	815	-
Platoon blocked, %	-	-	-	-	-	-	-	-	-	-	-	-
Mov Cap-1 Maneuver	1558	-	-	1577	-	-	752	707	1031	768	715	1024
Mov Cap-2 Maneuver	-	-	-	-	-	-	752	707	-	768	715	-
Stage 1	-	-	-	-	-	-	892	799	-	935	844	-
Stage 2	-	-	-	-	-	-	904	836	-	865	799	-

Approach	EB	WB	NB	SB
HCM Control Delay, s	3.1	0.7	9.9	9.8
HCM LOS			A	A

Minor Lane/Major Mvmt	NBLn1	EBL	EBT	EBR	WBL	WBT	WBR	SBLn1
Capacity (veh/h)	760	1558	-	-	1577	-	-	787
HCM Lane V/C Ratio	0.035	0.019	-	-	0.004	-	-	0.047
HCM Control Delay (s)	9.9	7.4	0	-	7.3	0	-	9.8
HCM Lane LOS	A	A	A	-	A	A	-	A
HCM 95th %tile Q(veh)	0.1	0.1	-	-	0	-	-	0.1

Intersection

Int Delay, s/veh 6.9

Movement	EBL	EBT	EBR	WBL	WBT	WBR	NBL	NBT	NBR	SBL	SBT	SBR
Lane Configurations		↕			↕			↕			↕	
Traffic Vol, veh/h	2	37	3	10	37	2	7	13	7	8	16	3
Future Vol, veh/h	2	37	3	10	37	2	7	13	7	8	16	3
Conflicting Peds, #/hr	4	0	0	0	0	4	1	0	1	1	0	1
Sign Control	Stop	Stop	Stop	Stop	Stop	Stop	Free	Free	Free	Free	Free	Free
RT Channelized	-	-	None	-	-	None	-	-	None	-	-	None
Storage Length	-	-	-	-	-	-	-	-	-	-	-	-
Veh in Median Storage, #	-	0	-	-	0	-	-	0	-	-	0	-
Grade, %	-	0	-	-	0	-	-	0	-	-	0	-
Peak Hour Factor	84	84	84	84	84	84	84	84	84	84	84	84
Heavy Vehicles, %	0	0	0	0	0	0	0	8	14	0	6	0
Mvmt Flow	2	44	4	12	44	2	8	15	8	10	19	4

Major/Minor	Minor2			Minor1			Major1			Major2		
Conflicting Flow All	105	82	22	101	80	25	24	0	0	25	0	0
Stage 1	41	41	-	37	37	-	-	-	-	-	-	-
Stage 2	64	41	-	64	43	-	-	-	-	-	-	-
Critical Hdwy	7.1	6.5	6.2	7.1	6.5	6.2	4.1	-	-	4.1	-	-
Critical Hdwy Stg 1	6.1	5.5	-	6.1	5.5	-	-	-	-	-	-	-
Critical Hdwy Stg 2	6.1	5.5	-	6.1	5.5	-	-	-	-	-	-	-
Follow-up Hdwy	3.5	4	3.3	3.5	4	3.3	2.2	-	-	2.2	-	-
Pot Cap-1 Maneuver	880	812	1061	885	814	1057	1604	-	-	1603	-	-
Stage 1	979	865	-	984	868	-	-	-	-	-	-	-
Stage 2	952	865	-	952	863	-	-	-	-	-	-	-
Platoon blocked, %												
Mov Cap-1 Maneuver	830	802	1060	837	804	1052	1604	-	-	1597	-	-
Mov Cap-2 Maneuver	830	802	-	837	804	-	-	-	-	-	-	-
Stage 1	973	859	-	978	863	-	-	-	-	-	-	-
Stage 2	893	860	-	895	857	-	-	-	-	-	-	-

Approach	EB	WB	NB	SB
HCM Control Delay, s	9.7	9.7	1.9	2.2
HCM LOS	A	A		

Minor Lane/Major Mvmt	NBL	NBT	NBR	EBLn1	WBLn1	SBL	SBT	SBR
Capacity (veh/h)	1604	-	-	818	818	1597	-	-
HCM Lane V/C Ratio	0.005	-	-	0.061	0.071	0.006	-	-
HCM Control Delay (s)	7.3	0	-	9.7	9.7	7.3	0	-
HCM Lane LOS	A	A	-	A	A	A	A	-
HCM 95th %tile Q(veh)	0	-	-	0.2	0.2	0	-	-

Intersection	
Intersection Delay, s/veh	7.2
Intersection LOS	A

Movement	EBU	EBL	EBT	EBR	WBU	WBL	WBT	WBR	NBU	NBL	NBT	NBR
Lane Configurations			↕				↕				↕	
Traffic Vol, veh/h	0	4	45	3	0	2	40	0	0	4	1	4
Future Vol, veh/h	0	4	45	3	0	2	40	0	0	4	1	4
Peak Hour Factor	0.92	0.83	0.83	0.83	0.92	0.83	0.83	0.83	0.92	0.83	0.83	0.83
Heavy Vehicles, %	2	0	2	0	2	0	0	0	2	0	0	0
Mvmt Flow	0	5	54	4	0	2	48	0	0	5	1	5
Number of Lanes	0	0	1	0	0	0	1	0	0	0	1	0

Approach	EB	WB	NB
Opposing Approach	WB	EB	SB
Opposing Lanes	1	1	1
Conflicting Approach Left	SB	NB	EB
Conflicting Lanes Left	1	1	1
Conflicting Approach Right	NB	SB	WB
Conflicting Lanes Right	1	1	1
HCM Control Delay	7.3	7.2	7
HCM LOS	A	A	A

Lane	NBLn1	EBLn1	WBLn1	SBLn1
Vol Left, %	44%	8%	5%	0%
Vol Thru, %	11%	87%	95%	14%
Vol Right, %	44%	6%	0%	86%
Sign Control	Stop	Stop	Stop	Stop
Traffic Vol by Lane	9	52	42	7
LT Vol	4	4	2	0
Through Vol	1	45	40	1
RT Vol	4	3	0	6
Lane Flow Rate	11	63	51	8
Geometry Grp	1	1	1	1
Degree of Util (X)	0.012	0.069	0.056	0.008
Departure Headway (Hd)	3.924	3.952	3.99	3.59
Convergence, Y/N	Yes	Yes	Yes	Yes
Cap	907	908	899	990
Service Time	1.971	1.967	2.007	1.638
HCM Lane V/C Ratio	0.012	0.069	0.057	0.008
HCM Control Delay	7	7.3	7.2	6.7
HCM Lane LOS	A	A	A	A
HCM 95th-tile Q	0	0.2	0.2	0

Intersection				
Intersection Delay, s/veh				
Intersection LOS				
Movement	SBU	SBL	SBT	SBR
Lane Configurations			↕	
Traffic Vol, veh/h	0	0	1	6
Future Vol, veh/h	0	0	1	6
Peak Hour Factor	0.92	0.83	0.83	0.83
Heavy Vehicles, %	2	0	0	0
Mvmt Flow	0	0	1	7
Number of Lanes	0	0	1	0
Approach			SB	
Opposing Approach			NB	
Opposing Lanes			1	
Conflicting Approach Left			WB	
Conflicting Lanes Left			1	
Conflicting Approach Right			EB	
Conflicting Lanes Right			1	
HCM Control Delay			6.7	
HCM LOS			A	

Intersection

Int Delay, s/veh 0.2

Movement	EBL	EBR	NBL	NBT	SBT	SBR
Lane Configurations	Y			Y	Y	
Traffic Vol, veh/h	3	8	4	747	960	5
Future Vol, veh/h	3	8	4	747	960	5
Conflicting Peds, #/hr	0	0	1	0	0	1
Sign Control	Stop	Stop	Free	Free	Free	Free
RT Channelized	-	None	-	None	-	None
Storage Length	0	-	-	-	-	-
Veh in Median Storage, #	0	-	-	0	0	-
Grade, %	0	-	-	0	0	-
Peak Hour Factor	95	95	95	95	95	95
Heavy Vehicles, %	2	2	2	2	2	2
Mvmt Flow	3	8	4	786	1011	5

Major/Minor	Minor2	Major1		Major2
Conflicting Flow All	1809	1014	1017	0
Stage 1	1014	-	-	-
Stage 2	795	-	-	-
Critical Hdwy	6.42	6.22	4.12	-
Critical Hdwy Stg 1	5.42	-	-	-
Critical Hdwy Stg 2	5.42	-	-	-
Follow-up Hdwy	3.518	3.318	2.218	-
Pot Cap-1 Maneuver	87	290	682	-
Stage 1	350	-	-	-
Stage 2	445	-	-	-
Platoon blocked, %				-
Mov Cap-1 Maneuver	86	290	682	-
Mov Cap-2 Maneuver	86	-	-	-
Stage 1	350	-	-	-
Stage 2	440	-	-	-

Approach	EB	NB	SB
HCM Control Delay, s	26.9	0.1	0
HCM LOS	D		

Minor Lane/Major Mvmt	NBL	NBT	EBLn1	SBT	SBR
Capacity (veh/h)	682	-	176	-	-
HCM Lane V/C Ratio	0.006	-	0.066	-	-
HCM Control Delay (s)	10.3	0	26.9	-	-
HCM Lane LOS	B	A	D	-	-
HCM 95th %tile Q(veh)	0	-	0.2	-	-

Appendix 8 Cumulative Conditions Level-of-Service Worksheets

Intersection

Int Delay, s/veh 0.8

Movement	WBL	WBR	NBT	NBR	SBL	SBT
Lane Configurations	↘		↑	↗		↖
Traffic Vol, veh/h	17	9	857	18	2	954
Future Vol, veh/h	17	9	857	18	2	954
Conflicting Peds, #/hr	0	0	0	0	0	0
Sign Control	Stop	Stop	Free	Free	Free	Free
RT Channelized	-	None	-	None	-	None
Storage Length	0	-	-	125	-	-
Veh in Median Storage, #	0	-	0	-	-	0
Grade, %	0	-	0	-	-	0
Peak Hour Factor	92	92	92	92	92	92
Heavy Vehicles, %	0	0	6	0	0	4
Mvmt Flow	18	10	932	20	2	1037

Major/Minor	Minor1		Major1		Major2	
Conflicting Flow All	1973	932	0	0	932	0
Stage 1	932	-	-	-	-	-
Stage 2	1041	-	-	-	-	-
Critical Hdwy	6.4	6.2	-	-	4.1	-
Critical Hdwy Stg 1	5.4	-	-	-	-	-
Critical Hdwy Stg 2	5.4	-	-	-	-	-
Follow-up Hdwy	3.5	3.3	-	-	2.2	-
Pot Cap-1 Maneuver	69	326	-	-	743	-
Stage 1	386	-	-	-	-	-
Stage 2	343	-	-	-	-	-
Platoon blocked, %			-	-		
Mov Cap-1 Maneuver	69	326	-	-	743	-
Mov Cap-2 Maneuver	69	-	-	-	-	-
Stage 1	386	-	-	-	-	-
Stage 2	341	-	-	-	-	-

Approach	WB		NB		SB
HCM Control Delay, s	58.2		0		0
HCM LOS	F				

Minor Lane/Major Mvmt	NBT	NBRWBLn1	SBL	SBT
Capacity (veh/h)	-	- 95	743	-
HCM Lane V/C Ratio	-	- 0.297	0.003	-
HCM Control Delay (s)	-	- 58.2	9.9	0
HCM Lane LOS	-	- F	A	A
HCM 95th %tile Q(veh)	-	- 1.1	0	-

Intersection

Int Delay, s/veh 0.3

Movement	EBL	EBT	EBR	WBL	WBT	WBR	NBL	NBT	NBR	SBL	SBT	SBR
Lane Configurations		↔			↔		↑	↑		↑	↑	
Traffic Vol, veh/h	5	0	2	0	0	0	0	863	0	0	997	5
Future Vol, veh/h	5	0	2	0	0	0	0	863	0	0	997	5
Conflicting Peds, #/hr	1	0	0	0	0	1	1	0	1	1	0	1
Sign Control	Stop	Stop	Stop	Stop	Stop	Stop	Free	Free	Free	Free	Free	Free
RT Channelized	-	-	None	-	-	None	-	-	None	-	-	None
Storage Length	-	-	-	-	-	-	65	-	-	50	-	-
Veh in Median Storage, #	-	0	-	-	0	-	-	0	-	-	0	-
Grade, %	-	0	-	-	0	-	-	0	-	-	0	-
Peak Hour Factor	93	93	93	93	93	93	93	93	93	93	93	93
Heavy Vehicles, %	0	0	0	0	0	0	0	6	0	0	4	0
Mvmt Flow	5	0	2	0	0	0	0	928	0	0	1072	5

Major/Minor	Minor2			Minor1			Major1			Major2		
Conflicting Flow All	2005	2005	1076	2005	2007	930	1078	0	0	929	0	0
Stage 1	1076	1076	-	929	929	-	-	-	-	-	-	-
Stage 2	929	929	-	1076	1078	-	-	-	-	-	-	-
Critical Hdwy	7.1	6.5	6.2	7.1	6.5	6.2	4.1	-	-	4.1	-	-
Critical Hdwy Stg 1	6.1	5.5	-	6.1	5.5	-	-	-	-	-	-	-
Critical Hdwy Stg 2	6.1	5.5	-	6.1	5.5	-	-	-	-	-	-	-
Follow-up Hdwy	3.5	4	3.3	3.5	4	3.3	2.2	-	-	2.2	-	-
Pot Cap-1 Maneuver	45	60	269	45	60	327	655	-	-	744	-	-
Stage 1	268	298	-	324	349	-	-	-	-	-	-	-
Stage 2	324	349	-	268	297	-	-	-	-	-	-	-
Platoon blocked, %												
Mov Cap-1 Maneuver	45	60	269	45	60	326	655	-	-	743	-	-
Mov Cap-2 Maneuver	45	60	-	45	60	-	-	-	-	-	-	-
Stage 1	268	298	-	324	349	-	-	-	-	-	-	-
Stage 2	324	349	-	266	297	-	-	-	-	-	-	-

Approach	EB	WB	NB	SB
HCM Control Delay, s	74.7	0	0	0
HCM LOS	F	A		

Minor Lane/Major Mvmt	NBL	NBT	NBR	EBLn1WBLn1	SBL	SBT	SBR
Capacity (veh/h)	655	-	-	59	-	743	-
HCM Lane V/C Ratio	-	-	-	0.128	-	-	-
HCM Control Delay (s)	0	-	-	74.7	0	0	-
HCM Lane LOS	A	-	-	F	A	A	-
HCM 95th %tile Q(veh)	0	-	-	0.4	-	0	-

Intersection

Int Delay, s/veh 0.3

Movement	WBL	WBR	NBT	NBR	SBL	SBT
Lane Configurations	↘		↗		↘	↗
Traffic Vol, veh/h	0	27	809	0	6	980
Future Vol, veh/h	0	27	809	0	6	980
Conflicting Peds, #/hr	0	0	0	0	0	0
Sign Control	Stop	Stop	Free	Free	Free	Free
RT Channelized	-	None	-	None	-	None
Storage Length	0	-	-	-	65	-
Veh in Median Storage, #	0	-	0	-	-	0
Grade, %	0	-	0	-	-	0
Peak Hour Factor	92	92	92	92	92	92
Heavy Vehicles, %	0	0	6	0	0	4
Mvmt Flow	0	29	879	0	7	1065

Major/Minor	Minor1		Major1		Major2	
Conflicting Flow All	1957	879	0	0	879	0
Stage 1	879	-	-	-	-	-
Stage 2	1078	-	-	-	-	-
Critical Hdwy	6.4	6.2	-	-	4.1	-
Critical Hdwy Stg 1	5.4	-	-	-	-	-
Critical Hdwy Stg 2	5.4	-	-	-	-	-
Follow-up Hdwy	3.5	3.3	-	-	2.2	-
Pot Cap-1 Maneuver	71	350	-	-	777	-
Stage 1	409	-	-	-	-	-
Stage 2	330	-	-	-	-	-
Platoon blocked, %			-	-		
Mov Cap-1 Maneuver	70	350	-	-	777	-
Mov Cap-2 Maneuver	70	-	-	-	-	-
Stage 1	409	-	-	-	-	-
Stage 2	327	-	-	-	-	-

Approach	WB		NB		SB
HCM Control Delay, s	16.2		0		0.1
HCM LOS	C				

Minor Lane/Major Mvmt	NBT	NBRWBLn1	SBL	SBT
Capacity (veh/h)	-	- 350	777	-
HCM Lane V/C Ratio	-	- 0.084	0.008	-
HCM Control Delay (s)	-	- 16.2	9.7	-
HCM Lane LOS	-	- C	A	-
HCM 95th %tile Q(veh)	-	- 0.3	0	-

Intersection

Int Delay, s/veh 7.4

Movement	WBL	WBR	NBT	NBR	SBL	SBT
Lane Configurations	Y		P			A
Traffic Vol, veh/h	2	26	2	0	6	2
Future Vol, veh/h	2	26	2	0	6	2
Conflicting Peds, #/hr	0	0	0	0	0	0
Sign Control	Stop	Stop	Free	Free	Free	Free
RT Channelized	-	None	-	None	-	None
Storage Length	0	-	-	-	-	-
Veh in Median Storage, #	0	-	0	-	-	0
Grade, %	0	-	0	-	-	0
Peak Hour Factor	75	75	75	75	75	75
Heavy Vehicles, %	0	0	0	0	0	0
Mvmt Flow	3	35	3	0	8	3

Major/Minor	Minor1		Major1		Major2	
Conflicting Flow All	22	3	0	0	3	0
Stage 1	3	-	-	-	-	-
Stage 2	19	-	-	-	-	-
Critical Hdwy	6.4	6.2	-	-	4.1	-
Critical Hdwy Stg 1	5.4	-	-	-	-	-
Critical Hdwy Stg 2	5.4	-	-	-	-	-
Follow-up Hdwy	3.5	3.3	-	-	2.2	-
Pot Cap-1 Maneuver	1000	1087	-	-	1632	-
Stage 1	1025	-	-	-	-	-
Stage 2	1009	-	-	-	-	-
Platoon blocked, %			-	-		
Mov Cap-1 Maneuver	995	1087	-	-	1632	-
Mov Cap-2 Maneuver	995	-	-	-	-	-
Stage 1	1025	-	-	-	-	-
Stage 2	1004	-	-	-	-	-

Approach	WB		NB		SB
HCM Control Delay, s	8.5		0		5.4
HCM LOS	A				

Minor Lane/Major Mvmt	NBT	NBRWBLn1	SBL	SBT
Capacity (veh/h)	-	- 1080	1632	-
HCM Lane V/C Ratio	-	- 0.035	0.005	-
HCM Control Delay (s)	-	- 8.5	7.2	0
HCM Lane LOS	-	- A	A	A
HCM 95th %tile Q(veh)	-	- 0.1	0	-

Intersection

Int Delay, s/veh 5.5

Movement	EBT	EBR	WBL	WBT	NBL	NBR
Lane Configurations	↔			↔	↔	
Traffic Vol, veh/h	3	4	0	5	21	0
Future Vol, veh/h	3	4	0	5	21	0
Conflicting Peds, #/hr	0	0	0	0	0	1
Sign Control	Free	Free	Free	Free	Stop	Stop
RT Channelized	-	None	-	None	-	None
Storage Length	-	-	-	-	0	-
Veh in Median Storage, #	0	-	-	0	0	-
Grade, %	0	-	-	0	0	-
Peak Hour Factor	70	70	70	70	70	70
Heavy Vehicles, %	0	0	0	0	0	0
Mvmt Flow	4	6	0	7	30	0

Major/Minor	Major1	Major2	Minor1
Conflicting Flow All	0	10	14
Stage 1	-	-	7
Stage 2	-	-	7
Critical Hdwy	-	4.1	6.4
Critical Hdwy Stg 1	-	-	5.4
Critical Hdwy Stg 2	-	-	5.4
Follow-up Hdwy	-	2.2	3.5
Pot Cap-1 Maneuver	-	1623	1010
Stage 1	-	-	1021
Stage 2	-	-	1021
Platoon blocked, %	-	-	-
Mov Cap-1 Maneuver	-	1621	1010
Mov Cap-2 Maneuver	-	-	1010
Stage 1	-	-	1021
Stage 2	-	-	1021

Approach	EB	WB	NB
HCM Control Delay, s	0	0	8.7
HCM LOS			A

Minor Lane/Major Mvmt	NBLn1	EBT	EBR	WBL	WBT
Capacity (veh/h)	1010	-	-	1621	-
HCM Lane V/C Ratio	0.03	-	-	-	-
HCM Control Delay (s)	8.7	-	-	0	-
HCM Lane LOS	A	-	-	A	-
HCM 95th %tile Q(veh)	0.1	-	-	0	-

Intersection

Int Delay, s/veh 0.8

Movement	EBL	EBT	EBR	WBL	WBT	WBR	NBL	NBT	NBR	SBL	SBT	SBR
Lane Configurations		↕			↕		↕	↕		↕	↕	
Traffic Vol, veh/h	4	0	6	3	0	31	5	756	5	12	951	0
Future Vol, veh/h	4	0	6	3	0	31	5	756	5	12	951	0
Conflicting Peds, #/hr	0	0	0	0	0	0	1	0	0	0	0	1
Sign Control	Stop	Stop	Stop	Stop	Stop	Stop	Free	Free	Free	Free	Free	Free
RT Channelized	-	-	None	-	-	None	-	-	None	-	-	None
Storage Length	-	-	-	-	-	-	125	-	-	125	-	-
Veh in Median Storage, #	-	0	-	-	0	-	-	0	-	-	0	-
Grade, %	-	0	-	-	0	-	-	0	-	-	0	-
Peak Hour Factor	90	90	90	90	90	90	90	90	90	90	90	90
Heavy Vehicles, %	0	0	0	0	0	4	0	6	0	0	4	0
Mvmt Flow	4	0	7	3	0	34	6	840	6	13	1057	0



















Major/Minor	Minor2			Minor1			Major1			Major2		
Conflicting Flow All	1955	1941	1058	1941	1938	843	1058	0	0	846	0	0
Stage 1	1084	1084	-	854	854	-	-	-	-	-	-	-
Stage 2	871	857	-	1087	1084	-	-	-	-	-	-	-
Critical Hdwy	7.1	6.5	6.2	7.1	6.5	6.24	4.1	-	-	4.1	-	-
Critical Hdwy Stg 1	6.1	5.5	-	6.1	5.5	-	-	-	-	-	-	-
Critical Hdwy Stg 2	6.1	5.5	-	6.1	5.5	-	-	-	-	-	-	-
Follow-up Hdwy	3.5	4	3.3	3.5	4	3.336	2.2	-	-	2.2	-	-
Pot Cap-1 Maneuver	49	66	276	50	66	361	666	-	-	800	-	-
Stage 1	265	296	-	356	378	-	-	-	-	-	-	-
Stage 2	349	377	-	264	296	-	-	-	-	-	-	-
Platoon blocked, %												
Mov Cap-1 Maneuver	43	64	276	48	64	361	666	-	-	800	-	-
Mov Cap-2 Maneuver	43	64	-	48	64	-	-	-	-	-	-	-
Stage 1	262	291	-	353	375	-	-	-	-	-	-	-
Stage 2	313	374	-	253	291	-	-	-	-	-	-	-

Approach	EB	WB	NB	SB
HCM Control Delay, s	52.3	23.8	0.1	0.1
HCM LOS	F	C		

Minor Lane/Major Mvmt	NBL	NBT	NBR	EBLn1WBLn1	SBL	SBT	SBR
Capacity (veh/h)	666	-	-	87	229	800	-
HCM Lane V/C Ratio	0.008	-	-	0.128	0.165	0.017	-
HCM Control Delay (s)	10.5	-	-	52.3	23.8	9.6	-
HCM Lane LOS	B	-	-	F	C	A	-
HCM 95th %tile Q(veh)	0	-	-	0.4	0.6	0.1	-

HCM Signalized Intersection Capacity Analysis
7: Highway 1 & California Avenue & Wienke Way

Cumulative Weekday AM

													
Movement	EBL	EBT	EBR	WBL	WBT	WBR2	NBL2	NBL	NBT	NBR	SBL	SBT	
Lane Configurations													
Traffic Volume (vph)	12	0	13	56	0	18	5	9	752	25	7	943	
Future Volume (vph)	12	0	13	56	0	18	5	9	752	25	7	943	
Ideal Flow (vphpl)	1900	1900	1900	1900	1900	1900	1900	1900	1900	1900	1900	1900	
Total Lost time (s)		4.5			4.5			4.5	4.5		4.5	4.5	
Lane Util. Factor		1.00			1.00			1.00	1.00		1.00	1.00	
Frb, ped/bikes		0.99			1.00			1.00	1.00		1.00	1.00	
Flpb, ped/bikes		1.00			1.00			1.00	1.00		1.00	1.00	
Frt		0.93			0.97			1.00	1.00		1.00	1.00	
Flt Protected		0.98			0.96			0.95	1.00		0.95	1.00	
Satd. Flow (prot)		1673			1734			1770	1854		1770	1861	
Flt Permitted		0.87			0.76			0.18	1.00		0.27	1.00	
Satd. Flow (perm)		1498			1368			337	1854		500	1861	
Peak-hour factor, PHF	0.93	0.93	0.93	0.93	0.93	0.93	0.93	0.92	0.93	0.93	0.93	0.93	
Adj. Flow (vph)	13	0	14	60	0	19	5	10	809	27	8	1014	
RTOR Reduction (vph)	0	25	0	0	43	0	0	0	1	0	0	0	
Lane Group Flow (vph)	0	2	0	0	36	0	0	15	835	0	8	1022	
Confl. Peds. (#/hr)			1	1									
Turn Type	Perm	NA		Perm	NA		Perm	Perm	NA		Perm	NA	
Protected Phases		8			4				6			2	
Permitted Phases	8			4			6	6			2		
Actuated Green, G (s)		9.2			9.2			77.0	77.0		77.0	77.0	
Effective Green, g (s)		9.2			9.2			77.0	77.0		77.0	77.0	
Actuated g/C Ratio		0.09			0.09			0.75	0.75		0.75	0.75	
Clearance Time (s)		4.5			4.5			4.5	4.5		4.5	4.5	
Vehicle Extension (s)		3.0			3.0			3.0	3.0		3.0	3.0	
Lane Grp Cap (vph)		133			122			251	1384		373	1389	
v/s Ratio Prot									0.45			c0.55	
v/s Ratio Perm		0.00			c0.03			0.04			0.02		
v/c Ratio		0.02			0.30			0.06	0.60		0.02	0.74	
Uniform Delay, d1		42.8			43.9			3.5	6.0		3.4	7.3	
Progression Factor		1.00			1.00			1.00	1.00		1.00	1.00	
Incremental Delay, d2		0.1			1.4			0.1	0.7		0.0	2.1	
Delay (s)		42.9			45.3			3.6	6.8		3.4	9.4	
Level of Service		D			D			A	A		A	A	
Approach Delay (s)		42.9			45.3				6.7			9.4	
Approach LOS		D			D				A			A	
Intersection Summary													
HCM 2000 Control Delay			10.3									HCM 2000 Level of Service	B
HCM 2000 Volume to Capacity ratio			0.67										
Actuated Cycle Length (s)			103.1									Sum of lost time (s)	13.5
Intersection Capacity Utilization			72.5%									ICU Level of Service	C
Analysis Period (min)			15										
c Critical Lane Group													

HCM Signalized Intersection Capacity Analysis
 7: Highway 1 & California Avenue & Wienke Way

Cumulative Weekday AM

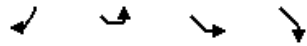

Movement	SBR	SEL2	SEL	SER
Lane Configurations				
Traffic Volume (vph)	7	4	0	7
Future Volume (vph)	7	4	0	7
Ideal Flow (vphpl)	1900	1900	1900	1900
Total Lost time (s)			4.5	
Lane Util. Factor			1.00	
Frbp, ped/bikes			1.00	
Flpb, ped/bikes			1.00	
Frt			0.91	
Flt Protected			0.98	
Satd. Flow (prot)			1667	
Flt Permitted			0.98	
Satd. Flow (perm)			1667	
Peak-hour factor, PHF	0.93	0.92	0.92	0.92
Adj. Flow (vph)	8	4	0	8
RTOR Reduction (vph)	0	0	0	0
Lane Group Flow (vph)	0	0	12	0
Confl. Peds. (#/hr)				
Turn Type		Perm	Prot	
Protected Phases			9	
Permitted Phases		9		
Actuated Green, G (s)			3.4	
Effective Green, g (s)			3.4	
Actuated g/C Ratio			0.03	
Clearance Time (s)			4.5	
Vehicle Extension (s)			3.0	
Lane Grp Cap (vph)			54	
v/s Ratio Prot				
v/s Ratio Perm			0.01	
v/c Ratio			0.22	
Uniform Delay, d1			48.6	
Progression Factor			1.00	
Incremental Delay, d2			2.1	
Delay (s)			50.6	
Level of Service			D	
Approach Delay (s)			50.6	
Approach LOS			D	
Intersection Summary				

Intersection

Int Delay, s/veh 1.9

Movement	EBL	EBT	EBR	WBL	WBT	WBR	NBL	NBT	NBR	SBL	SBT	SBR
Lane Configurations		↕			↕			↕			↕	
Traffic Vol, veh/h	7	19	0	2	76	0	4	3	0	3	3	4
Future Vol, veh/h	7	19	0	2	76	0	4	3	0	3	3	4
Conflicting Peds, #/hr	1	0	0	0	0	1	0	0	1	1	0	0
Sign Control	Free	Free	Free	Free	Free	Free	Stop	Stop	Stop	Stop	Stop	Stop
RT Channelized	-	-	None	-	-	None	-	-	None	-	-	None
Storage Length	-	-	-	-	-	-	-	-	-	-	-	-
Veh in Median Storage, #	-	0	-	-	0	-	-	0	-	-	0	-
Grade, %	-	0	-	-	0	-	-	0	-	-	0	-
Peak Hour Factor	74	74	74	74	74	74	74	74	74	74	74	74
Heavy Vehicles, %	0	0	0	0	0	0	33	0	0	0	0	0
Mvmt Flow	9	26	0	3	103	0	5	4	0	4	4	5

Major/Minor	Major1			Major2			Minor1			Minor2		
Conflicting Flow All	104	0	0	26	0	0	158	154	27	157	154	104
Stage 1	-	-	-	-	-	-	45	45	-	109	109	-
Stage 2	-	-	-	-	-	-	113	109	-	48	45	-
Critical Hdwy	4.1	-	-	4.1	-	-	7.43	6.5	6.2	7.1	6.5	6.2
Critical Hdwy Stg 1	-	-	-	-	-	-	6.43	5.5	-	6.1	5.5	-
Critical Hdwy Stg 2	-	-	-	-	-	-	6.43	5.5	-	6.1	5.5	-
Follow-up Hdwy	2.2	-	-	2.2	-	-	3.797	4	3.3	3.5	4	3.3
Pot Cap-1 Maneuver	1500	-	-	1601	-	-	743	741	1054	814	741	956
Stage 1	-	-	-	-	-	-	896	861	-	901	809	-
Stage 2	-	-	-	-	-	-	822	809	-	971	861	-
Platoon blocked, %		-	-		-	-						
Mov Cap-1 Maneuver	1500	-	-	1599	-	-	731	734	1053	804	734	955
Mov Cap-2 Maneuver	-	-	-	-	-	-	731	734	-	804	734	-
Stage 1	-	-	-	-	-	-	891	856	-	895	807	-
Stage 2	-	-	-	-	-	-	812	807	-	960	856	-

Approach	EB		WB		NB		SB
HCM Control Delay, s	2		0.2		10		9.4
HCM LOS					B		A

Minor Lane/Major Mvmt	NBLn1	EBL	EBT	EBR	WBL	WBT	WBR	SBLn1
Capacity (veh/h)	732	1500	-	-	1599	-	-	833
HCM Lane V/C Ratio	0.013	0.006	-	-	0.002	-	-	0.016
HCM Control Delay (s)	10	7.4	0	-	7.3	0	-	9.4
HCM Lane LOS	B	A	A	-	A	A	-	A
HCM 95th %tile Q(veh)	0	0	-	-	0	-	-	0

Intersection

Int Delay, s/veh 7.8

Movement	EBL	EBT	EBR	WBL	WBT	WBR	NBL	NBT	NBR	SBL	SBT	SBR
Lane Configurations		↕			↕			↕			↕	
Traffic Vol, veh/h	0	17	0	2	76	11	3	20	0	2	5	0
Future Vol, veh/h	0	17	0	2	76	11	3	20	0	2	5	0
Conflicting Peds, #/hr	1	0	0	0	0	1	0	0	0	0	0	0
Sign Control	Stop	Stop	Stop	Stop	Stop	Stop	Free	Free	Free	Free	Free	Free
RT Channelized	-	-	None	-	-	None	-	-	None	-	-	None
Storage Length	-	-	-	-	-	-	-	-	-	-	-	-
Veh in Median Storage, #	-	0	-	-	0	-	-	0	-	-	0	-
Grade, %	-	0	-	-	0	-	-	0	-	-	0	-
Peak Hour Factor	83	83	83	83	83	83	83	83	83	83	83	83
Heavy Vehicles, %	0	0	0	0	0	0	0	6	0	0	0	0
Mvmt Flow	0	20	0	2	92	13	4	24	0	2	6	0

Major/Minor	Minor2			Minor1			Major1			Major2		
Conflicting Flow All	96	42	6	52	42	25	6	0	0	24	0	0
Stage 1	11	11	-	31	31	-	-	-	-	-	-	-
Stage 2	85	31	-	21	11	-	-	-	-	-	-	-
Critical Hdwy	7.1	6.5	6.2	7.1	6.5	6.2	4.1	-	-	4.1	-	-
Critical Hdwy Stg 1	6.1	5.5	-	6.1	5.5	-	-	-	-	-	-	-
Critical Hdwy Stg 2	6.1	5.5	-	6.1	5.5	-	-	-	-	-	-	-
Follow-up Hdwy	3.5	4	3.3	3.5	4	3.3	2.2	-	-	2.2	-	-
Pot Cap-1 Maneuver	891	854	1083	952	854	1057	1628	-	-	1604	-	-
Stage 1	1015	890	-	991	873	-	-	-	-	-	-	-
Stage 2	928	873	-	1003	890	-	-	-	-	-	-	-
Platoon blocked, %												
Mov Cap-1 Maneuver	805	851	1083	932	851	1056	1628	-	-	1602	-	-
Mov Cap-2 Maneuver	805	851	-	932	851	-	-	-	-	-	-	-
Stage 1	1013	889	-	989	871	-	-	-	-	-	-	-
Stage 2	818	871	-	979	889	-	-	-	-	-	-	-

Approach	EB	WB	NB	SB
HCM Control Delay, s	9.3	9.7	0.9	2.1
HCM LOS	A	A		

Minor Lane/Major Mvmt	NBL	NBT	NBR	EBLn1WBLn1	SBL	SBT	SBR
Capacity (veh/h)	1628	-	-	851	874	1602	-
HCM Lane V/C Ratio	0.002	-	-	0.024	0.123	0.002	-
HCM Control Delay (s)	7.2	0	-	9.3	9.7	7.3	0
HCM Lane LOS	A	A	-	A	A	A	A
HCM 95th %tile Q(veh)	0	-	-	0.1	0.4	0	-

Intersection	
Intersection Delay, s/veh	7.3
Intersection LOS	A

Movement	EBU	EBL	EBT	EBR	WBU	WBL	WBT	WBR	NBU	NBL	NBT	NBR
Lane Configurations			↕				↕				↕	
Traffic Vol, veh/h	0	0	20	2	0	6	73	2	0	2	2	3
Future Vol, veh/h	0	0	20	2	0	6	73	2	0	2	2	3
Peak Hour Factor	0.92	0.90	0.90	0.90	0.92	0.90	0.90	0.90	0.92	0.90	0.90	0.90
Heavy Vehicles, %	2	0	6	0	2	0	0	0	2	0	0	0
Mvmt Flow	0	0	22	2	0	7	81	2	0	2	2	3
Number of Lanes	0	0	1	0	0	0	1	0	0	0	1	0

Approach	EB	WB	NB
Opposing Approach	WB	EB	SB
Opposing Lanes	1	1	1
Conflicting Approach Left	SB	NB	EB
Conflicting Lanes Left	1	1	1
Conflicting Approach Right	NB	SB	WB
Conflicting Lanes Right	1	1	1
HCM Control Delay	7.2	7.4	7
HCM LOS	A	A	A

Lane	NBLn1	EBLn1	WBLn1	SBLn1
Vol Left, %	29%	0%	7%	0%
Vol Thru, %	29%	91%	90%	0%
Vol Right, %	43%	9%	2%	100%
Sign Control	Stop	Stop	Stop	Stop
Traffic Vol by Lane	7	22	81	7
LT Vol	2	0	6	0
Through Vol	2	20	73	0
RT Vol	3	2	2	7
Lane Flow Rate	8	24	90	8
Geometry Grp	1	1	1	1
Degree of Util (X)	0.008	0.027	0.099	0.008
Departure Headway (Hd)	3.904	4.042	3.946	3.504
Convergence, Y/N	Yes	Yes	Yes	Yes
Cap	911	887	912	1014
Service Time	1.952	2.062	1.954	1.551
HCM Lane V/C Ratio	0.009	0.027	0.099	0.008
HCM Control Delay	7	7.2	7.4	6.6
HCM Lane LOS	A	A	A	A
HCM 95th-tile Q	0	0.1	0.3	0

Intersection

Intersection Delay, s/veh
 Intersection LOS

Movement	SBU	SBL	SBT	SBR
Lane Configurations			↕	
Traffic Vol, veh/h	0	0	0	7
Future Vol, veh/h	0	0	0	7
Peak Hour Factor	0.92	0.90	0.90	0.90
Heavy Vehicles, %	2	0	0	0
Mvmt Flow	0	0	0	8
Number of Lanes	0	0	1	0

Approach	SB
Opposing Approach	NB
Opposing Lanes	1
Conflicting Approach Left	WB
Conflicting Lanes Left	1
Conflicting Approach Right	EB
Conflicting Lanes Right	1
HCM Control Delay	6.6
HCM LOS	A

Intersection

Int Delay, s/veh 0.8

Movement	WBL	WBR	NBT	NBR	SBL	SBT
Lane Configurations	↘↙		↑	↗		↖
Traffic Vol, veh/h	13	6	1037	21	6	1078
Future Vol, veh/h	13	6	1037	21	6	1078
Conflicting Peds, #/hr	0	0	0	1	1	0
Sign Control	Stop	Stop	Free	Free	Free	Free
RT Channelized	-	None	-	None	-	None
Storage Length	0	-	-	125	-	-
Veh in Median Storage, #	0	-	0	-	-	0
Grade, %	0	-	0	-	-	0
Peak Hour Factor	95	95	95	95	95	95
Heavy Vehicles, %	0	0	2	0	0	2
Mvmt Flow	14	6	1092	22	6	1135

Major/Minor	Minor1		Major1		Major2	
Conflicting Flow All	2240	1093	0	0	1093	0
Stage 1	1093	-	-	-	-	-
Stage 2	1147	-	-	-	-	-
Critical Hdwy	6.4	6.2	-	-	4.1	-
Critical Hdwy Stg 1	5.4	-	-	-	-	-
Critical Hdwy Stg 2	5.4	-	-	-	-	-
Follow-up Hdwy	3.5	3.3	-	-	2.2	-
Pot Cap-1 Maneuver	47	263	-	-	646	-
Stage 1	324	-	-	-	-	-
Stage 2	305	-	-	-	-	-
Platoon blocked, %			-	-		
Mov Cap-1 Maneuver	46	263	-	-	646	-
Mov Cap-2 Maneuver	46	-	-	-	-	-
Stage 1	324	-	-	-	-	-
Stage 2	297	-	-	-	-	-

Approach	WB		NB		SB
HCM Control Delay, s	88.6		0		0.1
HCM LOS	F				

Minor Lane/Major Mvmt	NBT	NBRWBLn1	SBL	SBT
Capacity (veh/h)	-	- 62	646	-
HCM Lane V/C Ratio	-	- 0.323	0.01	-
HCM Control Delay (s)	-	- 88.6	10.6	0
HCM Lane LOS	-	- F	B	A
HCM 95th %tile Q(veh)	-	- 1.2	0	-

Intersection

Int Delay, s/veh 0.7

Movement	EBL	EBT	EBR	WBL	WBT	WBR	NBL	NBT	NBR	SBL	SBT	SBR
Lane Configurations		↔			↔		↑	↑		↑	↑	
Traffic Vol, veh/h	6	0	5	2	0	3	0	1046	0	2	1084	5
Future Vol, veh/h	6	0	5	2	0	3	0	1046	0	2	1084	5
Conflicting Peds, #/hr	5	0	0	0	0	5	0	0	4	4	0	0
Sign Control	Stop	Stop	Stop	Stop	Stop	Stop	Free	Free	Free	Free	Free	Free
RT Channelized	-	-	None	-	-	None	-	-	None	-	-	None
Storage Length	-	-	-	-	-	-	65	-	-	50	-	-
Veh in Median Storage, #	-	0	-	-	0	-	-	0	-	-	0	-
Grade, %	-	0	-	-	0	-	-	0	-	-	0	-
Peak Hour Factor	94	94	94	94	94	94	94	94	94	94	94	94
Heavy Vehicles, %	0	0	0	0	0	0	0	2	0	0	1	0
Mvmt Flow	6	0	5	2	0	3	0	1113	0	2	1153	5

Major/Minor	Minor2			Minor1			Major1			Major2		
Conflicting Flow All	2279	2277	1156	2280	2280	1122	1159	0	0	1117	0	0
Stage 1	1160	1160	-	1117	1117	-	-	-	-	-	-	-
Stage 2	1119	1117	-	1163	1163	-	-	-	-	-	-	-
Critical Hdwy	7.1	6.5	6.2	7.1	6.5	6.2	4.1	-	-	4.1	-	-
Critical Hdwy Stg 1	6.1	5.5	-	6.1	5.5	-	-	-	-	-	-	-
Critical Hdwy Stg 2	6.1	5.5	-	6.1	5.5	-	-	-	-	-	-	-
Follow-up Hdwy	3.5	4	3.3	3.5	4	3.3	2.2	-	-	2.2	-	-
Pot Cap-1 Maneuver	29	41	242	29	40	253	610	-	-	633	-	-
Stage 1	240	272	-	254	285	-	-	-	-	-	-	-
Stage 2	253	285	-	239	271	-	-	-	-	-	-	-
Platoon blocked, %												
Mov Cap-1 Maneuver	28	41	242	28	40	251	610	-	-	630	-	-
Mov Cap-2 Maneuver	28	41	-	28	40	-	-	-	-	-	-	-
Stage 1	240	271	-	253	284	-	-	-	-	-	-	-
Stage 2	249	284	-	233	270	-	-	-	-	-	-	-

Approach	EB	WB	NB	SB
HCM Control Delay, s	105.3	70.8	0	0
HCM LOS	F	F		

Minor Lane/Major Mvmt	NBL	NBT	NBR	EBLn1	WBLn1	SBL	SBT	SBR
Capacity (veh/h)	610	-	-	47	60	630	-	-
HCM Lane V/C Ratio	-	-	-	0.249	0.089	0.003	-	-
HCM Control Delay (s)	0	-	-	105.3	70.8	10.7	-	-
HCM Lane LOS	A	-	-	F	F	B	-	-
HCM 95th %tile Q(veh)	0	-	-	0.8	0.3	0	-	-

Intersection

Int Delay, s/veh 0.2

Movement	WBL	WBR	NBT	NBR	SBL	SBT
Lane Configurations	Y		P		T	T
Traffic Vol, veh/h	0	6	1035	0	21	1059
Future Vol, veh/h	0	6	1035	0	21	1059
Conflicting Peds, #/hr	0	0	0	2	2	0
Sign Control	Stop	Stop	Free	Free	Free	Free
RT Channelized	-	None	-	None	-	None
Storage Length	0	-	-	-	65	-
Veh in Median Storage, #	0	-	0	-	-	0
Grade, %	0	-	0	-	-	0
Peak Hour Factor	96	96	96	96	96	96
Heavy Vehicles, %	0	0	2	0	0	2
Mvmt Flow	0	6	1078	0	22	1103

Major/Minor	Minor1		Major1		Major2	
Conflicting Flow All	2227	1080	0	0	1080	0
Stage 1	1080	-	-	-	-	-
Stage 2	1147	-	-	-	-	-
Critical Hdwy	6.4	6.2	-	-	4.1	-
Critical Hdwy Stg 1	5.4	-	-	-	-	-
Critical Hdwy Stg 2	5.4	-	-	-	-	-
Follow-up Hdwy	3.5	3.3	-	-	2.2	-
Pot Cap-1 Maneuver	48	268	-	-	653	-
Stage 1	329	-	-	-	-	-
Stage 2	305	-	-	-	-	-
Platoon blocked, %			-	-		
Mov Cap-1 Maneuver	46	267	-	-	653	-
Mov Cap-2 Maneuver	46	-	-	-	-	-
Stage 1	328	-	-	-	-	-
Stage 2	295	-	-	-	-	-

Approach	WB		NB		SB
HCM Control Delay, s	18.8		0		0.2
HCM LOS	C				

Minor Lane/Major Mvmt	NBT	NBRWBLn1	SBL	SBT
Capacity (veh/h)	-	- 267	653	-
HCM Lane V/C Ratio	-	- 0.023	0.033	-
HCM Control Delay (s)	-	- 18.8	10.7	-
HCM Lane LOS	-	- C	B	-
HCM 95th %tile Q(veh)	-	- 0.1	0.1	-

Intersection

Int Delay, s/veh 6.2

Movement	WBL	WBR	NBT	NBR	SBL	SBT
Lane Configurations	Y		P			A
Traffic Vol, veh/h	5	7	2	7	22	0
Future Vol, veh/h	5	7	2	7	22	0
Conflicting Peds, #/hr	1	0	0	5	5	0
Sign Control	Stop	Stop	Free	Free	Free	Free
RT Channelized	-	None	-	None	-	None
Storage Length	0	-	-	-	-	-
Veh in Median Storage, #	0	-	0	-	-	0
Grade, %	0	-	0	-	-	0
Peak Hour Factor	75	75	75	75	75	75
Heavy Vehicles, %	0	17	0	0	0	0
Mvmt Flow	7	9	3	9	29	0

Major/Minor	Minor1		Major1		Major2	
Conflicting Flow All	72	12	0	0	17	0
Stage 1	12	-	-	-	-	-
Stage 2	60	-	-	-	-	-
Critical Hdwy	6.4	6.37	-	-	4.1	-
Critical Hdwy Stg 1	5.4	-	-	-	-	-
Critical Hdwy Stg 2	5.4	-	-	-	-	-
Follow-up Hdwy	3.5	3.453	-	-	2.2	-
Pot Cap-1 Maneuver	937	1027	-	-	1613	-
Stage 1	1016	-	-	-	-	-
Stage 2	968	-	-	-	-	-
Platoon blocked, %			-	-		
Mov Cap-1 Maneuver	915	1022	-	-	1613	-
Mov Cap-2 Maneuver	915	-	-	-	-	-
Stage 1	1011	-	-	-	-	-
Stage 2	950	-	-	-	-	-

Approach	WB		NB		SB
HCM Control Delay, s	8.8		0		7.3
HCM LOS	A				

Minor Lane/Major Mvmt	NBT	NBRWBLn1	SBL	SBT
Capacity (veh/h)	-	- 975	1613	-
HCM Lane V/C Ratio	-	- 0.016	0.018	-
HCM Control Delay (s)	-	- 8.8	7.3	0
HCM Lane LOS	-	- A	A	A
HCM 95th %tile Q(veh)	-	- 0.1	0.1	-

Intersection

Int Delay, s/veh 2.1

Movement	EBT	EBR	WBL	WBT	NBL	NBR
Lane Configurations	↔		↔		↔	
Traffic Vol, veh/h	10	19	2	5	9	0
Future Vol, veh/h	10	19	2	5	9	0
Conflicting Peds, #/hr	0	3	3	0	1	0
Sign Control	Free	Free	Free	Free	Stop	Stop
RT Channelized	-	None	-	None	-	None
Storage Length	-	-	-	-	0	-
Veh in Median Storage, #	0	-	-	0	0	-
Grade, %	0	-	-	0	0	-
Peak Hour Factor	69	69	69	69	69	69
Heavy Vehicles, %	0	0	0	0	29	0
Mvmt Flow	14	28	3	7	13	0

Major/Minor	Major1	Major2	Minor1
Conflicting Flow All	0	45	45
Stage 1	-	-	31
Stage 2	-	-	14
Critical Hdwy	-	4.1	6.69
Critical Hdwy Stg 1	-	-	5.69
Critical Hdwy Stg 2	-	-	5.69
Follow-up Hdwy	-	2.2	3.761
Pot Cap-1 Maneuver	-	1576	901
Stage 1	-	-	926
Stage 2	-	-	943
Platoon blocked, %	-	-	-
Mov Cap-1 Maneuver	-	1576	896
Mov Cap-2 Maneuver	-	-	896
Stage 1	-	-	923
Stage 2	-	-	940

Approach	EB	WB	NB
HCM Control Delay, s	0	2.1	9.1
HCM LOS			A

Minor Lane/Major Mvmt	NBLn1	EBT	EBR	WBL	WBT
Capacity (veh/h)	896	-	-	1576	-
HCM Lane V/C Ratio	0.015	-	-	0.002	-
HCM Control Delay (s)	9.1	-	-	7.3	0
HCM Lane LOS	A	-	-	A	A
HCM 95th %tile Q(veh)	0	-	-	0	-

Intersection

Int Delay, s/veh 2.2

Movement	EBL	EBT	EBR	WBL	WBT	WBR	NBL	NBT	NBR	SBL	SBT	SBR
Lane Configurations		↔			↔		↑	↑		↑	↑	
Traffic Vol, veh/h	9	0	9	9	0	20	12	1001	9	33	990	6
Future Vol, veh/h	9	0	9	9	0	20	12	1001	9	33	990	6
Conflicting Peds, #/hr	0	0	0	0	0	0	0	0	2	2	0	0
Sign Control	Stop	Stop	Stop	Stop	Stop	Stop	Free	Free	Free	Free	Free	Free
RT Channelized	-	-	None	-	-	None	-	-	None	-	-	None
Storage Length	-	-	-	-	-	-	125	-	-	125	-	-
Veh in Median Storage, #	-	0	-	-	0	-	-	0	-	-	0	-
Grade, %	-	0	-	-	0	-	-	0	-	-	0	-
Peak Hour Factor	96	96	96	96	96	96	96	96	96	96	96	96
Heavy Vehicles, %	0	0	0	0	0	0	0	2	14	7	2	0
Mvmt Flow	9	0	9	9	0	21	13	1043	9	34	1031	6



















Major/Minor	Minor2			Minor1			Major1			Major2		
Conflicting Flow All	2186	2182	1034	2182	2180	1049	1038	0	0	1054	0	0
Stage 1	1103	1103	-	1074	1074	-	-	-	-	-	-	-
Stage 2	1083	1079	-	1108	1106	-	-	-	-	-	-	-
Critical Hdwy	7.1	6.5	6.2	7.1	6.5	6.2	4.1	-	-	4.17	-	-
Critical Hdwy Stg 1	6.1	5.5	-	6.1	5.5	-	-	-	-	-	-	-
Critical Hdwy Stg 2	6.1	5.5	-	6.1	5.5	-	-	-	-	-	-	-
Follow-up Hdwy	3.5	4	3.3	3.5	4	3.3	2.2	-	-	2.263	-	-
Pot Cap-1 Maneuver	33	47	285	34	47	279	678	-	-	642	-	-
Stage 1	259	290	-	269	299	-	-	-	-	-	-	-
Stage 2	265	297	-	257	289	-	-	-	-	-	-	-
Platoon blocked, %												
Mov Cap-1 Maneuver	29	44	285	31	44	278	678	-	-	642	-	-
Mov Cap-2 Maneuver	29	44	-	31	44	-	-	-	-	-	-	-
Stage 1	254	275	-	263	293	-	-	-	-	-	-	-
Stage 2	240	291	-	235	274	-	-	-	-	-	-	-

Approach	EB	WB	NB	SB
HCM Control Delay, s	106.3	75.1	0.1	0.4
HCM LOS	F	F		

Minor Lane/Major Mvmt	NBL	NBT	NBR	EBLn1	WBLn1	SBL	SBT	SBR
Capacity (veh/h)	678	-	-	53	80	642	-	-
HCM Lane V/C Ratio	0.018	-	-	0.354	0.378	0.054	-	-
HCM Control Delay (s)	10.4	-	-	106.3	75.1	10.9	-	-
HCM Lane LOS	B	-	-	F	F	B	-	-
HCM 95th %tile Q(veh)	0.1	-	-	1.3	1.5	0.2	-	-

HCM Signalized Intersection Capacity Analysis
7: Highway 1 & California Avenue & Wienke Way

Cumulative Weekday PM

													
Movement	EBL	EBT	EBR	WBL	WBT	WBR2	NBL2	NBL	NBT	NBR	SBL	SBT	
Lane Configurations													
Traffic Volume (vph)	4	0	4	37	0	16	6	10	1039	49	20	972	
Future Volume (vph)	4	0	4	37	0	16	6	10	1039	49	20	972	
Ideal Flow (vphpl)	1900	1900	1900	1900	1900	1900	1900	1900	1900	1900	1900	1900	
Total Lost time (s)		4.5			4.5			4.5	4.5		4.5	4.5	
Lane Util. Factor		1.00			1.00			1.00	1.00		1.00	1.00	
Frb, ped/bikes		0.99			1.00			1.00	1.00		1.00	1.00	
Flpb, ped/bikes		1.00			1.00			1.00	1.00		1.00	1.00	
Frt		0.93			0.96			1.00	0.99		1.00	1.00	
Flt Protected		0.98			0.97			0.95	1.00		0.95	1.00	
Satd. Flow (prot)		1676			1725			1770	1850		1770	1858	
Flt Permitted		0.90			0.79			0.19	1.00		0.14	1.00	
Satd. Flow (perm)		1554			1404			349	1850		259	1858	
Peak-hour factor, PHF	0.93	0.93	0.93	0.93	0.93	0.93	0.93	0.92	0.93	0.93	0.93	0.93	
Adj. Flow (vph)	4	0	4	40	0	17	6	11	1117	53	22	1045	
RTOR Reduction (vph)	0	7	0	0	41	0	0	0	1	0	0	0	
Lane Group Flow (vph)	0	1	0	0	16	0	0	17	1169	0	22	1060	
Confl. Peds. (#/hr)			1	1			1	1					
Turn Type	Perm	NA		Perm	NA		Perm	Perm	NA		Perm	NA	
Protected Phases		8			4				6			2	
Permitted Phases	8			4			6	6			2		
Actuated Green, G (s)		8.8			8.8			96.2	96.2		96.2	96.2	
Effective Green, g (s)		8.8			8.8			96.2	96.2		96.2	96.2	
Actuated g/C Ratio		0.07			0.07			0.79	0.79		0.79	0.79	
Clearance Time (s)		4.5			4.5			4.5	4.5		4.5	4.5	
Vehicle Extension (s)		3.0			3.0			3.0	3.0		3.0	3.0	
Lane Grp Cap (vph)		111			101			274	1455		203	1461	
v/s Ratio Prot									c0.63			0.57	
v/s Ratio Perm		0.00			c0.01			0.05			0.08		
v/c Ratio		0.01			0.16			0.06	0.80		0.11	0.73	
Uniform Delay, d1		52.7			53.3			2.9	7.6		3.0	6.5	
Progression Factor		1.00			1.00			1.00	1.00		1.00	1.00	
Incremental Delay, d2		0.0			0.7			0.1	3.3		0.2	1.8	
Delay (s)		52.7			54.0			3.0	10.9		3.3	8.3	
Level of Service		D			D			A	B		A	A	
Approach Delay (s)		52.7			54.0				10.8			8.2	
Approach LOS		D			D				B			A	
Intersection Summary													
HCM 2000 Control Delay			10.9									HCM 2000 Level of Service	B
HCM 2000 Volume to Capacity ratio			0.73										
Actuated Cycle Length (s)			122.3									Sum of lost time (s)	13.5
Intersection Capacity Utilization			77.9%									ICU Level of Service	D
Analysis Period (min)			15										
c Critical Lane Group													

HCM Signalized Intersection Capacity Analysis
 7: Highway 1 & California Avenue & Wienke Way

Cumulative Weekday PM



Movement	SBR	SBR2	SEL2	SEL	SER
Lane Configurations					
Traffic Volume (vph)	12	2	2	0	3
Future Volume (vph)	12	2	2	0	3
Ideal Flow (vphpl)	1900	1900	1900	1900	1900
Total Lost time (s)				4.5	
Lane Util. Factor				1.00	
Frbp, ped/bikes				1.00	
Flpb, ped/bikes				1.00	
Frt				0.92	
Flt Protected				0.98	
Satd. Flow (prot)				1678	
Flt Permitted				0.98	
Satd. Flow (perm)				1678	
Peak-hour factor, PHF	0.93	0.92	0.92	0.92	0.92
Adj. Flow (vph)	13	2	2	0	3
RTOR Reduction (vph)	0	0	0	0	0
Lane Group Flow (vph)	0	0	0	5	0
Confl. Peds. (#/hr)	1	1			
Turn Type			Perm	Prot	
Protected Phases				9	
Permitted Phases			9		
Actuated Green, G (s)				3.8	
Effective Green, g (s)				3.8	
Actuated g/C Ratio				0.03	
Clearance Time (s)				4.5	
Vehicle Extension (s)				3.0	
Lane Grp Cap (vph)				52	
v/s Ratio Prot					
v/s Ratio Perm				0.00	
v/c Ratio				0.10	
Uniform Delay, d1				57.6	
Progression Factor				1.00	
Incremental Delay, d2				0.8	
Delay (s)				58.4	
Level of Service				E	
Approach Delay (s)				58.4	
Approach LOS				E	
Intersection Summary					

Intersection

Int Delay, s/veh 4

Movement	EBL	EBT	EBR	WBL	WBT	WBR	NBL	NBT	NBR	SBL	SBT	SBR
Lane Configurations		↕			↕			↕			↕	
Traffic Vol, veh/h	16	41	3	0	40	5	11	9	7	4	10	14
Future Vol, veh/h	16	41	3	0	40	5	11	9	7	4	10	14
Conflicting Peds, #/hr	2	0	1	1	0	2	0	0	0	0	0	0
Sign Control	Free	Free	Free	Free	Free	Free	Stop	Stop	Stop	Stop	Stop	Stop
RT Channelized	-	-	None	-	-	None	-	-	None	-	-	None
Storage Length	-	-	-	-	-	-	-	-	-	-	-	-
Veh in Median Storage, #	-	0	-	-	0	-	-	0	-	-	0	-
Grade, %	-	0	-	-	0	-	-	0	-	-	0	-
Peak Hour Factor	79	79	79	79	79	79	79	79	79	79	79	79
Heavy Vehicles, %	0	3	0	0	0	0	0	0	0	33	0	0
Mvmt Flow	20	52	4	0	51	6	14	11	9	5	13	18

Major/Minor	Major1			Major2			Minor1			Minor2		
Conflicting Flow All	59	0	0	57	0	0	164	154	55	160	153	56
Stage 1	-	-	-	-	-	-	95	95	-	56	56	-
Stage 2	-	-	-	-	-	-	69	59	-	104	97	-
Critical Hdwy	4.1	-	-	4.1	-	-	7.1	6.5	6.2	7.43	6.5	6.2
Critical Hdwy Stg 1	-	-	-	-	-	-	6.1	5.5	-	6.43	5.5	-
Critical Hdwy Stg 2	-	-	-	-	-	-	6.1	5.5	-	6.43	5.5	-
Follow-up Hdwy	2.2	-	-	2.2	-	-	3.5	4	3.3	3.797	4	3.3
Pot Cap-1 Maneuver	1558	-	-	1560	-	-	805	741	1018	741	742	1016
Stage 1	-	-	-	-	-	-	917	820	-	883	852	-
Stage 2	-	-	-	-	-	-	946	850	-	831	819	-
Platoon blocked, %	-	-	-	-	-	-	-	-	-	-	-	-
Mov Cap-1 Maneuver	1558	-	-	1560	-	-	772	729	1017	717	730	1014
Mov Cap-2 Maneuver	-	-	-	-	-	-	772	729	-	717	730	-
Stage 1	-	-	-	-	-	-	904	809	-	870	850	-
Stage 2	-	-	-	-	-	-	916	848	-	802	808	-

Approach	EB	WB	NB	SB
HCM Control Delay, s	2	0	9.7	9.4
HCM LOS			A	A

Minor Lane/Major Mvmt	NBLn1	EBL	EBT	EBR	WBL	WBT	WBR	SBLn1
Capacity (veh/h)	807	1558	-	-	1560	-	-	846
HCM Lane V/C Ratio	0.042	0.013	-	-	-	-	-	0.042
HCM Control Delay (s)	9.7	7.3	0	-	0	-	-	9.4
HCM Lane LOS	A	A	A	-	A	-	-	A
HCM 95th %tile Q(veh)	0.1	0	-	-	0	-	-	0.1

Intersection

Int Delay, s/veh 7.6

Movement	EBL	EBT	EBR	WBL	WBT	WBR	NBL	NBT	NBR	SBL	SBT	SBR
Lane Configurations		↕			↕			↕			↕	
Traffic Vol, veh/h	0	46	4	11	39	3	5	7	6	18	14	3
Future Vol, veh/h	0	46	4	11	39	3	5	7	6	18	14	3
Conflicting Peds, #/hr	3	0	0	0	0	3	3	0	2	2	0	3
Sign Control	Stop	Stop	Stop	Stop	Stop	Stop	Free	Free	Free	Free	Free	Free
RT Channelized	-	-	None	-	-	None	-	-	None	-	-	None
Storage Length	-	-	-	-	-	-	-	-	-	-	-	-
Veh in Median Storage, #	-	0	-	-	0	-	-	0	-	-	0	-
Grade, %	-	0	-	-	0	-	-	0	-	-	0	-
Peak Hour Factor	86	86	86	86	86	86	86	86	86	86	86	86
Heavy Vehicles, %	0	5	0	22	0	0	0	0	0	0	8	0
Mvmt Flow	0	53	5	13	45	3	6	8	7	21	16	3

Major/Minor	Minor2			Minor1			Major1			Major2		
Conflicting Flow All	114	92	21	114	90	17	23	0	0	17	0	0
Stage 1	63	63	-	25	25	-	-	-	-	-	-	-
Stage 2	51	29	-	89	65	-	-	-	-	-	-	-
Critical Hdwy	7.1	6.55	6.2	7.32	6.5	6.2	4.1	-	-	4.1	-	-
Critical Hdwy Stg 1	6.1	5.55	-	6.32	5.5	-	-	-	-	-	-	-
Critical Hdwy Stg 2	6.1	5.55	-	6.32	5.5	-	-	-	-	-	-	-
Follow-up Hdwy	3.5	4.045	3.3	3.698	4	3.3	2.2	-	-	2.2	-	-
Pot Cap-1 Maneuver	868	792	1062	818	804	1068	1605	-	-	1613	-	-
Stage 1	953	837	-	944	878	-	-	-	-	-	-	-
Stage 2	967	865	-	871	845	-	-	-	-	-	-	-
Platoon blocked, %												
Mov Cap-1 Maneuver	812	775	1059	760	787	1063	1605	-	-	1608	-	-
Mov Cap-2 Maneuver	812	775	-	760	787	-	-	-	-	-	-	-
Stage 1	946	824	-	938	873	-	-	-	-	-	-	-
Stage 2	908	860	-	800	832	-	-	-	-	-	-	-

Approach	EB	WB	NB	SB
HCM Control Delay, s	9.9	9.9	2	3.7
HCM LOS	A	A		

Minor Lane/Major Mvmt	NBL	NBT	NBR	EBLn1WBLn1	SBL	SBT	SBR
Capacity (veh/h)	1605	-	-	792	793	1608	-
HCM Lane V/C Ratio	0.004	-	-	0.073	0.078	0.013	-
HCM Control Delay (s)	7.3	0	-	9.9	9.9	7.3	0
HCM Lane LOS	A	A	-	A	A	A	A
HCM 95th %tile Q(veh)	0	-	-	0.2	0.3	0	-

Intersection	
Intersection Delay, s/veh	7.4
Intersection LOS	A

Movement	EBU	EBL	EBT	EBR	WBU	WBL	WBT	WBR	NBU	NBL	NBT	NBR
Lane Configurations			↕				↕				↕	
Traffic Vol, veh/h	0	3	62	7	0	2	37	0	0	6	3	4
Future Vol, veh/h	0	3	62	7	0	2	37	0	0	6	3	4
Peak Hour Factor	0.92	0.75	0.75	0.75	0.92	0.75	0.75	0.75	0.92	0.75	0.75	0.75
Heavy Vehicles, %	2	0	4	0	2	0	0	0	2	40	0	0
Mvmt Flow	0	4	83	9	0	3	49	0	0	8	4	5
Number of Lanes	0	0	1	0	0	0	1	0	0	0	1	0

Approach	EB	WB	NB
Opposing Approach	WB	EB	SB
Opposing Lanes	1	1	1
Conflicting Approach Left	SB	NB	EB
Conflicting Lanes Left	1	1	1
Conflicting Approach Right	NB	SB	WB
Conflicting Lanes Right	1	1	1
HCM Control Delay	7.4	7.3	7.9
HCM LOS	A	A	A

Lane	NBLn1	EBLn1	WBLn1	SBLn1
Vol Left, %	46%	4%	5%	0%
Vol Thru, %	23%	86%	95%	0%
Vol Right, %	31%	10%	0%	100%
Sign Control	Stop	Stop	Stop	Stop
Traffic Vol by Lane	13	72	39	5
LT Vol	6	3	2	0
Through Vol	3	62	37	0
RT Vol	4	7	0	5
Lane Flow Rate	17	96	52	7
Geometry Grp	1	1	1	1
Degree of Util (X)	0.023	0.105	0.058	0.007
Departure Headway (Hd)	4.748	3.93	4.023	3.566
Convergence, Y/N	Yes	Yes	Yes	Yes
Cap	749	911	888	991
Service Time	2.811	1.958	2.058	1.634
HCM Lane V/C Ratio	0.023	0.105	0.059	0.007
HCM Control Delay	7.9	7.4	7.3	6.7
HCM Lane LOS	A	A	A	A
HCM 95th-tile Q	0.1	0.4	0.2	0

Intersection

Intersection Delay, s/veh

Intersection LOS

Movement	SBU	SBL	SBT	SBR
Lane Configurations			↕	
Traffic Vol, veh/h	0	0	0	5
Future Vol, veh/h	0	0	0	5
Peak Hour Factor	0.92	0.75	0.75	0.75
Heavy Vehicles, %	2	0	0	0
Mvmt Flow	0	0	0	7
Number of Lanes	0	0	1	0

Approach SB

Opposing Approach	NB
Opposing Lanes	1
Conflicting Approach Left	WB
Conflicting Lanes Left	1
Conflicting Approach Right	EB
Conflicting Lanes Right	1
HCM Control Delay	6.7
HCM LOS	A

Intersection

Int Delay, s/veh 0.4

Movement	WBL	WBR	NBT	NBR	SBL	SBT
Lane Configurations	↘↙		↑	↗		↖
Traffic Vol, veh/h	9	4	1008	11	5	957
Future Vol, veh/h	9	4	1008	11	5	957
Conflicting Peds, #/hr	0	0	0	1	1	0
Sign Control	Stop	Stop	Free	Free	Free	Free
RT Channelized	-	None	-	None	-	None
Storage Length	0	-	-	125	-	-
Veh in Median Storage, #	0	-	0	-	-	0
Grade, %	0	-	0	-	-	0
Peak Hour Factor	96	96	96	96	96	96
Heavy Vehicles, %	0	0	2	0	0	1
Mvmt Flow	9	4	1050	11	5	997

Major/Minor	Minor1		Major1		Major2	
Conflicting Flow All	2058	1051	0	0	1051	0
Stage 1	1051	-	-	-	-	-
Stage 2	1007	-	-	-	-	-
Critical Hdwy	6.4	6.2	-	-	4.1	-
Critical Hdwy Stg 1	5.4	-	-	-	-	-
Critical Hdwy Stg 2	5.4	-	-	-	-	-
Follow-up Hdwy	3.5	3.3	-	-	2.2	-
Pot Cap-1 Maneuver	61	278	-	-	670	-
Stage 1	339	-	-	-	-	-
Stage 2	356	-	-	-	-	-
Platoon blocked, %			-	-		
Mov Cap-1 Maneuver	60	278	-	-	670	-
Mov Cap-2 Maneuver	60	-	-	-	-	-
Stage 1	339	-	-	-	-	-
Stage 2	350	-	-	-	-	-

Approach	WB		NB		SB
HCM Control Delay, s	59.8		0		0.1
HCM LOS	F				

Minor Lane/Major Mvmt	NBT	NBRWBLn1	SBL	SBT
Capacity (veh/h)	-	-	79	670
HCM Lane V/C Ratio	-	-	0.171	0.008
HCM Control Delay (s)	-	-	59.8	10.4
HCM Lane LOS	-	-	F	B
HCM 95th %tile Q(veh)	-	-	0.6	0

Intersection

Int Delay, s/veh 0.1

Movement	EBL	EBT	EBR	WBL	WBT	WBR	NBL	NBT	NBR	SBL	SBT	SBR
Lane Configurations		↔			↔		↑	↑		↑	↑	
Traffic Vol, veh/h	0	0	0	2	0	2	3	1005	0	2	966	5
Future Vol, veh/h	0	0	0	2	0	2	3	1005	0	2	966	5
Conflicting Peds, #/hr	0	0	1	1	0	0	0	0	3	3	0	0
Sign Control	Stop	Stop	Stop	Stop	Stop	Stop	Free	Free	Free	Free	Free	Free
RT Channelized	-	-	None	-	-	None	-	-	None	-	-	None
Storage Length	-	-	-	-	-	-	65	-	-	50	-	-
Veh in Median Storage, #	-	0	-	-	0	-	-	0	-	-	0	-
Grade, %	-	0	-	-	0	-	-	0	-	-	0	-
Peak Hour Factor	96	96	96	96	96	96	96	96	96	96	96	96
Heavy Vehicles, %	0	0	0	0	0	0	0	3	0	0	2	0
Mvmt Flow	0	0	0	2	0	2	3	1047	0	2	1006	5

Major/Minor	Minor2			Minor1			Major1			Major2		
Conflicting Flow All	2067	2069	1010	2070	2072	1050	1011	0	0	1050	0	0
Stage 1	1013	1013	-	1056	1056	-	-	-	-	-	-	-
Stage 2	1054	1056	-	1014	1016	-	-	-	-	-	-	-
Critical Hdwy	7.1	6.5	6.2	7.1	6.5	6.2	4.1	-	-	4.1	-	-
Critical Hdwy Stg 1	6.1	5.5	-	6.1	5.5	-	-	-	-	-	-	-
Critical Hdwy Stg 2	6.1	5.5	-	6.1	5.5	-	-	-	-	-	-	-
Follow-up Hdwy	3.5	4	3.3	3.5	4	3.3	2.2	-	-	2.2	-	-
Pot Cap-1 Maneuver	40	55	294	40	55	278	694	-	-	671	-	-
Stage 1	291	319	-	275	305	-	-	-	-	-	-	-
Stage 2	276	305	-	290	318	-	-	-	-	-	-	-
Platoon blocked, %												
Mov Cap-1 Maneuver	39	54	294	40	54	277	693	-	-	671	-	-
Mov Cap-2 Maneuver	39	54	-	40	54	-	-	-	-	-	-	-
Stage 1	290	318	-	273	303	-	-	-	-	-	-	-
Stage 2	273	303	-	289	317	-	-	-	-	-	-	-

Approach	EB	WB	NB	SB
HCM Control Delay, s	0	59.7	0	0
HCM LOS	A	F		

Minor Lane/Major Mvmt	NBL	NBT	NBR	EBLn1	WBLn1	SBL	SBT	SBR
Capacity (veh/h)	693	-	-	-	70	671	-	-
HCM Lane V/C Ratio	0.005	-	-	-	0.06	0.003	-	-
HCM Control Delay (s)	10.2	-	-	0	59.7	10.4	-	-
HCM Lane LOS	B	-	-	A	F	B	-	-
HCM 95th %tile Q(veh)	0	-	-	-	0.2	0	-	-

Intersection

Int Delay, s/veh 0.2

Movement	WBL	WBR	NBT	NBR	SBL	SBT
Lane Configurations	Y		P		T	T
Traffic Vol, veh/h	0	13	987	0	10	958
Future Vol, veh/h	0	13	987	0	10	958
Conflicting Peds, #/hr	0	0	0	1	1	0
Sign Control	Stop	Stop	Free	Free	Free	Free
RT Channelized	-	None	-	None	-	None
Storage Length	0	-	-	-	65	-
Veh in Median Storage, #	0	-	0	-	-	0
Grade, %	0	-	0	-	-	0
Peak Hour Factor	93	93	93	93	93	93
Heavy Vehicles, %	0	9	2	0	0	1
Mvmt Flow	0	14	1061	0	11	1030

Major/Minor	Minor1		Major1		Major2	
Conflicting Flow All	2114	1062	0	0	1062	0
Stage 1	1062	-	-	-	-	-
Stage 2	1052	-	-	-	-	-
Critical Hdwy	6.4	6.29	-	-	4.1	-
Critical Hdwy Stg 1	5.4	-	-	-	-	-
Critical Hdwy Stg 2	5.4	-	-	-	-	-
Follow-up Hdwy	3.5	3.381	-	-	2.2	-
Pot Cap-1 Maneuver	57	263	-	-	664	-
Stage 1	335	-	-	-	-	-
Stage 2	339	-	-	-	-	-
Platoon blocked, %			-	-		-
Mov Cap-1 Maneuver	56	263	-	-	664	-
Mov Cap-2 Maneuver	56	-	-	-	-	-
Stage 1	335	-	-	-	-	-
Stage 2	333	-	-	-	-	-

Approach	WB		NB		SB
HCM Control Delay, s	19.5		0		0.1
HCM LOS	C				

Minor Lane/Major Mvmt	NBT	NBRWBLn1	SBL	SBT
Capacity (veh/h)	-	- 263	664	-
HCM Lane V/C Ratio	-	- 0.053	0.016	-
HCM Control Delay (s)	-	- 19.5	10.5	-
HCM Lane LOS	-	- C	B	-
HCM 95th %tile Q(veh)	-	- 0.2	0	-

Intersection

Int Delay, s/veh 6.4

Movement	WBL	WBR	NBT	NBR	SBL	SBT
Lane Configurations	Y		P			A
Traffic Vol, veh/h	4	16	2	3	7	3
Future Vol, veh/h	4	16	2	3	7	3
Conflicting Peds, #/hr	2	0	0	0	0	0
Sign Control	Stop	Stop	Free	Free	Free	Free
RT Channelized	-	None	-	None	-	None
Storage Length	0	-	-	-	-	-
Veh in Median Storage, #	0	-	0	-	-	0
Grade, %	0	-	0	-	-	0
Peak Hour Factor	75	75	75	75	75	75
Heavy Vehicles, %	33	8	0	0	0	0
Mvmt Flow	5	21	3	4	9	4

Major/Minor	Minor1		Major1		Major2	
Conflicting Flow All	30	5	0	0	7	0
Stage 1	5	-	-	-	-	-
Stage 2	25	-	-	-	-	-
Critical Hdwy	6.73	6.28	-	-	4.1	-
Critical Hdwy Stg 1	5.73	-	-	-	-	-
Critical Hdwy Stg 2	5.73	-	-	-	-	-
Follow-up Hdwy	3.797	3.372	-	-	2.2	-
Pot Cap-1 Maneuver	911	1061	-	-	1627	-
Stage 1	943	-	-	-	-	-
Stage 2	923	-	-	-	-	-
Platoon blocked, %			-	-		
Mov Cap-1 Maneuver	904	1061	-	-	1627	-
Mov Cap-2 Maneuver	904	-	-	-	-	-
Stage 1	943	-	-	-	-	-
Stage 2	916	-	-	-	-	-

Approach	WB		NB		SB
HCM Control Delay, s	8.6		0		5.1
HCM LOS	A				

Minor Lane/Major Mvmt	NBT	NBRWBLn1	SBL	SBT
Capacity (veh/h)	-	- 1025	1627	-
HCM Lane V/C Ratio	-	- 0.026	0.006	-
HCM Control Delay (s)	-	- 8.6	7.2	0
HCM Lane LOS	-	- A	A	A
HCM 95th %tile Q(veh)	-	- 0.1	0	-

Intersection

Int Delay, s/veh 6

Movement	EBT	EBR	WBL	WBT	NBL	NBR
Lane Configurations	↔		↔		↔	
Traffic Vol, veh/h	3	6	2	0	16	2
Future Vol, veh/h	3	6	2	0	16	2
Conflicting Peds, #/hr	0	1	1	0	0	0
Sign Control	Free	Free	Free	Free	Stop	Stop
RT Channelized	-	None	-	None	-	None
Storage Length	-	-	-	-	0	-
Veh in Median Storage, #	0	-	-	0	0	-
Grade, %	0	-	-	0	0	-
Peak Hour Factor	79	79	79	79	79	79
Heavy Vehicles, %	0	0	100	0	15	0
Mvmt Flow	4	8	3	0	20	3

Major/Minor	Major1	Major2	Minor1
Conflicting Flow All	0	12	14
Stage 1	-	-	9
Stage 2	-	-	5
Critical Hdwy	-	5.1	7.25
Critical Hdwy Stg 1	-	-	6.25
Critical Hdwy Stg 2	-	-	6.25
Follow-up Hdwy	-	3.1	3.635
Pot Cap-1 Maneuver	-	1148	970
Stage 1	-	-	979
Stage 2	-	-	984
Platoon blocked, %	-	-	-
Mov Cap-1 Maneuver	-	1148	967
Mov Cap-2 Maneuver	-	-	967
Stage 1	-	-	979
Stage 2	-	-	981

Approach	EB	WB	NB
HCM Control Delay, s	0	8.1	8.8
HCM LOS			A

Minor Lane/Major Mvmt	NBLn1	EBT	EBR	WBL	WBT
Capacity (veh/h)	978	-	-	1148	-
HCM Lane V/C Ratio	0.023	-	-	0.002	-
HCM Control Delay (s)	8.8	-	-	8.1	0
HCM Lane LOS	A	-	-	A	A
HCM 95th %tile Q(veh)	0.1	-	-	0	-

Intersection

Int Delay, s/veh 1.1

Movement	EBL	EBT	EBR	WBL	WBT	WBR	NBL	NBT	NBR	SBL	SBT	SBR
Lane Configurations		↔			↔		↑	↑		↑	↑	
Traffic Vol, veh/h	0	0	7	7	2	29	11	713	3	26	928	6
Future Vol, veh/h	0	0	7	7	2	29	11	713	3	26	928	6
Conflicting Peds, #/hr	0	0	0	0	0	0	0	0	1	1	0	0
Sign Control	Stop	Stop	Stop	Stop	Stop	Stop	Free	Free	Free	Free	Free	Free
RT Channelized	-	-	None	-	-	None	-	-	None	-	-	None
Storage Length	-	-	-	-	-	-	125	-	-	125	-	-
Veh in Median Storage, #	-	0	-	-	0	-	-	0	-	-	0	-
Grade, %	-	0	-	-	0	-	-	0	-	-	0	-
Peak Hour Factor	95	95	95	95	95	95	95	95	95	95	95	95
Heavy Vehicles, %	0	0	0	17	0	4	0	3	0	5	1	0
Mvmt Flow	0	0	7	7	2	31	12	751	3	27	977	6

Major/Minor	Minor2			Minor1			Major1			Major2		
Conflicting Flow All	1827	1813	980	1814	1814	753	983	0	0	755	0	0
Stage 1	1035	1035	-	776	776	-	-	-	-	-	-	-
Stage 2	792	778	-	1038	1038	-	-	-	-	-	-	-
Critical Hdwy	7.1	6.5	6.2	7.27	6.5	6.24	4.1	-	-	4.15	-	-
Critical Hdwy Stg 1	6.1	5.5	-	6.27	5.5	-	-	-	-	-	-	-
Critical Hdwy Stg 2	6.1	5.5	-	6.27	5.5	-	-	-	-	-	-	-
Follow-up Hdwy	3.5	4	3.3	3.653	4	3.336	2.2	-	-	2.245	-	-
Pot Cap-1 Maneuver	60	79	306	55	79	406	711	-	-	842	-	-
Stage 1	282	312	-	369	410	-	-	-	-	-	-	-
Stage 2	385	410	-	261	311	-	-	-	-	-	-	-
Platoon blocked, %												
Mov Cap-1 Maneuver	52	75	306	52	75	406	711	-	-	842	-	-
Mov Cap-2 Maneuver	52	75	-	52	75	-	-	-	-	-	-	-
Stage 1	277	302	-	362	403	-	-	-	-	-	-	-
Stage 2	348	403	-	247	301	-	-	-	-	-	-	-



















Approach	EB	WB	NB	SB
HCM Control Delay, s	17.1	34.1	0.2	0.3
HCM LOS	C	D		

Minor Lane/Major Mvmt	NBL	NBT	NBR	EBLn1	WBLn1	SBL	SBT	SBR
Capacity (veh/h)	711	-	-	306	163	842	-	-
HCM Lane V/C Ratio	0.016	-	-	0.024	0.245	0.033	-	-
HCM Control Delay (s)	10.1	-	-	17.1	34.1	9.4	-	-
HCM Lane LOS	B	-	-	C	D	A	-	-
HCM 95th %tile Q(veh)	0.1	-	-	0.1	0.9	0.1	-	-

HCM Signalized Intersection Capacity Analysis

7: Highway 1 & California Avenue & Wienke Way

Cumulative Weekend Midday

													
Movement	EBL	EBT	EBR	WBL	WBT	WBR2	NBL2	NBL	NBT	NBR	SBL	SBT	
Lane Configurations													
Traffic Volume (vph)	7	4	25	27	4	27	33	5	697	42	9	928	
Future Volume (vph)	7	4	25	27	4	27	33	5	697	42	9	928	
Ideal Flow (vphpl)	1900	1900	1900	1900	1900	1900	1900	1900	1900	1900	1900	1900	
Total Lost time (s)		4.5			4.5			4.5	4.5		4.5	4.5	
Lane Util. Factor		1.00			1.00			1.00	1.00		1.00	1.00	
Fr _t		0.91			0.94			1.00	0.99		1.00	1.00	
Fl _t Protected		0.99			0.98			0.95	1.00		0.95	1.00	
Satd. Flow (prot)		1672			1705			1770	1847		1770	1858	
Fl _t Permitted		0.95			0.86			0.18	1.00		0.29	1.00	
Satd. Flow (perm)		1602			1508			333	1847		531	1858	
Peak-hour factor, PHF	0.93	0.93	0.93	0.93	0.93	0.93	0.93	0.92	0.93	0.93	0.93	0.93	
Adj. Flow (vph)	8	4	27	29	4	29	35	5	749	45	10	998	
RTOR Reduction (vph)	0	25	0	0	43	0	0	0	1	0	0	0	
Lane Group Flow (vph)	0	14	0	0	19	0	0	40	793	0	10	1015	
Turn Type	Perm	NA		Perm	NA		Perm	Perm	NA		Perm	NA	
Protected Phases		8			4				6			2	
Permitted Phases	8			4			6	6			2		
Actuated Green, G (s)		8.4			8.4			75.2	75.2		75.2	75.2	
Effective Green, g (s)		8.4			8.4			75.2	75.2		75.2	75.2	
Actuated g/C Ratio		0.08			0.08			0.74	0.74		0.74	0.74	
Clearance Time (s)		4.5			4.5			4.5	4.5		4.5	4.5	
Vehicle Extension (s)		3.0			3.0			3.0	3.0		3.0	3.0	
Lane Grp Cap (vph)		132			124			245	1364		392	1372	
v/s Ratio Prot									0.43			c0.55	
v/s Ratio Perm		0.01			c0.01			0.12			0.02		
v/c Ratio		0.11			0.15			0.16	0.58		0.03	0.74	
Uniform Delay, d ₁		43.2			43.4			4.0	6.1		3.5	7.7	
Progression Factor		1.00			1.00			1.00	1.00		1.00	1.00	
Incremental Delay, d ₂		0.4			0.6			0.3	0.6		0.0	2.1	
Delay (s)		43.6			44.0			4.3	6.7		3.6	9.8	
Level of Service		D			D			A	A		A	A	
Approach Delay (s)		43.6			44.0				6.6			9.7	
Approach LOS		D			D				A			A	
Intersection Summary													
HCM 2000 Control Delay			10.4									HCM 2000 Level of Service	B
HCM 2000 Volume to Capacity ratio			0.65										
Actuated Cycle Length (s)			101.8									Sum of lost time (s)	13.5
Intersection Capacity Utilization			72.2%									ICU Level of Service	C
Analysis Period (min)			15										

c Critical Lane Group

HCM Signalized Intersection Capacity Analysis
 7: Highway 1 & California Avenue & Wienke Way

Cumulative Weekend Midday



Movement	SBR	SBR2	SEL2	SEL	SER
Lane Configurations					
Traffic Volume (vph)	9	6	4	0	10
Future Volume (vph)	9	6	4	0	10
Ideal Flow (vphpl)	1900	1900	1900	1900	1900
Total Lost time (s)				4.5	
Lane Util. Factor				1.00	
Flt				0.90	
Flt Protected				0.99	
Satd. Flow (prot)				1656	
Flt Permitted				0.99	
Satd. Flow (perm)				1656	
Peak-hour factor, PHF	0.93	0.92	0.92	0.92	0.92
Adj. Flow (vph)	10	7	4	0	11
RTOR Reduction (vph)	0	0	0	0	0
Lane Group Flow (vph)	0	0	0	15	0
Turn Type			Perm	Prot	
Protected Phases				9	
Permitted Phases			9		
Actuated Green, G (s)				4.7	
Effective Green, g (s)				4.7	
Actuated g/C Ratio				0.05	
Clearance Time (s)				4.5	
Vehicle Extension (s)				3.0	
Lane Grp Cap (vph)				76	
v/s Ratio Prot					
v/s Ratio Perm				0.01	
v/c Ratio				0.20	
Uniform Delay, d1				46.7	
Progression Factor				1.00	
Incremental Delay, d2				1.3	
Delay (s)				48.0	
Level of Service				D	
Approach Delay (s)				48.0	
Approach LOS				D	
Intersection Summary					

Intersection												
Int Delay, s/veh	4.6											
Movement	EBL	EBT	EBR	WBL	WBT	WBR	NBL	NBT	NBR	SBL	SBT	SBR
Lane Configurations		↕			↕			↕			↕	
Traffic Vol, veh/h	29	39	3	6	36	20	12	11	4	7	20	10
Future Vol, veh/h	29	39	3	6	36	20	12	11	4	7	20	10
Conflicting Peds, #/hr	1	0	0	0	0	1	0	0	2	2	0	0
Sign Control	Free	Free	Free	Free	Free	Free	Stop	Stop	Stop	Stop	Stop	Stop
RT Channelized	-	-	None	-	-	None	-	-	None	-	-	None
Storage Length	-	-	-	-	-	-	-	-	-	-	-	-
Veh in Median Storage, #	-	0	-	-	0	-	-	0	-	-	0	-
Grade, %	-	0	-	-	0	-	-	0	-	-	0	-
Peak Hour Factor	83	83	83	83	83	83	83	83	83	83	83	83
Heavy Vehicles, %	0	0	0	0	0	0	0	0	0	0	0	0
Mvmt Flow	35	47	4	7	43	24	14	13	5	8	24	12
Major/Minor	Major1			Major2			Minor1			Minor2		
Conflicting Flow All	68	0	0	51	0	0	207	202	51	201	191	56
Stage 1	-	-	-	-	-	-	119	119	-	71	71	-
Stage 2	-	-	-	-	-	-	88	83	-	130	120	-
Critical Hdwy	4.1	-	-	4.1	-	-	7.1	6.5	6.2	7.1	6.5	6.2
Critical Hdwy Stg 1	-	-	-	-	-	-	6.1	5.5	-	6.1	5.5	-
Critical Hdwy Stg 2	-	-	-	-	-	-	6.1	5.5	-	6.1	5.5	-
Follow-up Hdwy	2.2	-	-	2.2	-	-	3.5	4	3.3	3.5	4	3.3
Pot Cap-1 Maneuver	1546	-	-	1568	-	-	755	698	1023	762	708	1016
Stage 1	-	-	-	-	-	-	890	801	-	944	840	-
Stage 2	-	-	-	-	-	-	925	830	-	878	800	-
Platoon blocked, %	-	-	-	-	-	-	-	-	-	-	-	-
Mov Cap-1 Maneuver	1546	-	-	1565	-	-	711	678	1021	729	688	1015
Mov Cap-2 Maneuver	-	-	-	-	-	-	711	678	-	729	688	-
Stage 1	-	-	-	-	-	-	870	783	-	921	835	-
Stage 2	-	-	-	-	-	-	883	825	-	838	782	-
Approach	EB			WB			NB			SB		
HCM Control Delay, s	3			0.7			10.2			10		
HCM LOS							B			B		
Minor Lane/Major Mvmt	NBLn1	EBL	EBT	EBR	WBL	WBT	WBR	SBLn1				
Capacity (veh/h)	729	1546	-	-	1565	-	-	763				
HCM Lane V/C Ratio	0.045	0.023	-	-	0.005	-	-	0.058				
HCM Control Delay (s)	10.2	7.4	0	-	7.3	0	-	10				
HCM Lane LOS	B	A	A	-	A	A	-	B				
HCM 95th %tile Q(veh)	0.1	0.1	-	-	0	-	-	0.2				

Intersection

Int Delay, s/veh 6.9

Movement	EBL	EBT	EBR	WBL	WBT	WBR	NBL	NBT	NBR	SBL	SBT	SBR
Lane Configurations		↕			↕			↕			↕	
Traffic Vol, veh/h	3	43	4	12	43	3	9	16	9	10	19	4
Future Vol, veh/h	3	43	4	12	43	3	9	16	9	10	19	4
Conflicting Peds, #/hr	4	0	0	0	0	4	1	0	1	1	0	1
Sign Control	Stop	Stop	Stop	Stop	Stop	Stop	Free	Free	Free	Free	Free	Free
RT Channelized	-	-	None	-	-	None	-	-	None	-	-	None
Storage Length	-	-	-	-	-	-	-	-	-	-	-	-
Veh in Median Storage, #	-	0	-	-	0	-	-	0	-	-	0	-
Grade, %	-	0	-	-	0	-	-	0	-	-	0	-
Peak Hour Factor	84	84	84	84	84	84	84	84	84	84	84	84
Heavy Vehicles, %	0	0	0	0	0	0	0	8	14	0	6	0
Mvmt Flow	4	51	5	14	51	4	11	19	11	12	23	5

Major/Minor	Minor2			Minor1			Major1			Major2		
Conflicting Flow All	127	102	26	124	99	29	28	0	0	31	0	0
Stage 1	50	50	-	47	47	-	-	-	-	-	-	-
Stage 2	77	52	-	77	52	-	-	-	-	-	-	-
Critical Hdwy	7.1	6.5	6.2	7.1	6.5	6.2	4.1	-	-	4.1	-	-
Critical Hdwy Stg 1	6.1	5.5	-	6.1	5.5	-	-	-	-	-	-	-
Critical Hdwy Stg 2	6.1	5.5	-	6.1	5.5	-	-	-	-	-	-	-
Follow-up Hdwy	3.5	4	3.3	3.5	4	3.3	2.2	-	-	2.2	-	-
Pot Cap-1 Maneuver	851	792	1056	855	795	1052	1599	-	-	1595	-	-
Stage 1	968	857	-	972	860	-	-	-	-	-	-	-
Stage 2	937	856	-	937	856	-	-	-	-	-	-	-
Platoon blocked, %												
Mov Cap-1 Maneuver	793	779	1055	799	782	1047	1599	-	-	1589	-	-
Mov Cap-2 Maneuver	793	779	-	799	782	-	-	-	-	-	-	-
Stage 1	960	849	-	964	853	-	-	-	-	-	-	-
Stage 2	868	849	-	870	848	-	-	-	-	-	-	-

Approach	EB	WB	NB	SB
HCM Control Delay, s	9.9	10	1.9	2.2
HCM LOS	A	B		

Minor Lane/Major Mvmt	NBL	NBT	NBR	EBLn1WBLn1	SBL	SBT	SBR
Capacity (veh/h)	1599	-	-	797	796	1589	-
HCM Lane V/C Ratio	0.007	-	-	0.075	0.087	0.007	-
HCM Control Delay (s)	7.3	0	-	9.9	10	7.3	0
HCM Lane LOS	A	A	-	A	B	A	A
HCM 95th %tile Q(veh)	0	-	-	0.2	0.3	0	-

Intersection	
Intersection Delay, s/veh	7.2
Intersection LOS	A

Movement	EBU	EBL	EBT	EBR	WBU	WBL	WBT	WBR	NBU	NBL	NBT	NBR
Lane Configurations			↕				↕				↕	
Traffic Vol, veh/h	0	5	52	4	0	3	47	0	0	5	2	5
Future Vol, veh/h	0	5	52	4	0	3	47	0	0	5	2	5
Peak Hour Factor	0.92	0.83	0.83	0.83	0.92	0.83	0.83	0.83	0.92	0.83	0.83	0.83
Heavy Vehicles, %	2	0	2	0	2	0	0	0	2	0	0	0
Mvmt Flow	0	6	63	5	0	4	57	0	0	6	2	6
Number of Lanes	0	0	1	0	0	0	1	0	0	0	1	0

Approach	EB	WB	NB
Opposing Approach	WB	EB	SB
Opposing Lanes	1	1	1
Conflicting Approach Left	SB	NB	EB
Conflicting Lanes Left	1	1	1
Conflicting Approach Right	NB	SB	WB
Conflicting Lanes Right	1	1	1
HCM Control Delay	7.3	7.3	7.1
HCM LOS	A	A	A

Lane	NBLn1	EBLn1	WBLn1	SBLn1
Vol Left, %	42%	8%	6%	0%
Vol Thru, %	17%	85%	94%	22%
Vol Right, %	42%	7%	0%	78%
Sign Control	Stop	Stop	Stop	Stop
Traffic Vol by Lane	12	61	50	9
LT Vol	5	5	3	0
Through Vol	2	52	47	2
RT Vol	5	4	0	7
Lane Flow Rate	14	73	60	11
Geometry Grp	1	1	1	1
Degree of Util (X)	0.016	0.081	0.067	0.011
Departure Headway (Hd)	3.973	3.968	4.012	3.675
Convergence, Y/N	Yes	Yes	Yes	Yes
Cap	894	904	893	965
Service Time	2.029	1.986	2.033	1.733
HCM Lane V/C Ratio	0.016	0.081	0.067	0.011
HCM Control Delay	7.1	7.3	7.3	6.8
HCM Lane LOS	A	A	A	A
HCM 95th-tile Q	0	0.3	0.2	0

Intersection

Intersection Delay, s/veh
 Intersection LOS

Movement	SBU	SBL	SBT	SBR
Lane Configurations			↕	
Traffic Vol, veh/h	0	0	2	7
Future Vol, veh/h	0	0	2	7
Peak Hour Factor	0.92	0.83	0.83	0.83
Heavy Vehicles, %	2	0	0	0
Mvmt Flow	0	0	2	8
Number of Lanes	0	0	1	0

Approach SB

Opposing Approach	NB
Opposing Lanes	1
Conflicting Approach Left	WB
Conflicting Lanes Left	1
Conflicting Approach Right	EB
Conflicting Lanes Right	1
HCM Control Delay	6.8
HCM LOS	A

Appendix 9 Cumulative with Project Level- of-Service Worksheets

Intersection

Int Delay, s/veh 0.8

Movement	WBL	WBR	NBT	NBR	SBL	SBT
Lane Configurations	↘↗		↑	↗		↖
Traffic Vol, veh/h	17	9	872	18	2	958
Future Vol, veh/h	17	9	872	18	2	958
Conflicting Peds, #/hr	0	0	0	0	0	0
Sign Control	Stop	Stop	Free	Free	Free	Free
RT Channelized	-	None	-	None	-	None
Storage Length	0	-	-	125	-	-
Veh in Median Storage, #	0	-	0	-	-	0
Grade, %	0	-	0	-	-	0
Peak Hour Factor	92	92	92	92	92	92
Heavy Vehicles, %	0	0	6	0	0	4
Mvmt Flow	18	10	948	20	2	1041

Major/Minor	Minor1		Major1		Major2	
Conflicting Flow All	1994	948	0	0	948	0
Stage 1	948	-	-	-	-	-
Stage 2	1046	-	-	-	-	-
Critical Hdwy	6.4	6.2	-	-	4.1	-
Critical Hdwy Stg 1	5.4	-	-	-	-	-
Critical Hdwy Stg 2	5.4	-	-	-	-	-
Follow-up Hdwy	3.5	3.3	-	-	2.2	-
Pot Cap-1 Maneuver	67	319	-	-	732	-
Stage 1	380	-	-	-	-	-
Stage 2	341	-	-	-	-	-
Platoon blocked, %			-	-		
Mov Cap-1 Maneuver	67	319	-	-	732	-
Mov Cap-2 Maneuver	67	-	-	-	-	-
Stage 1	380	-	-	-	-	-
Stage 2	339	-	-	-	-	-

Approach	WB		NB		SB
HCM Control Delay, s	60.6		0		0
HCM LOS	F				

Minor Lane/Major Mvmt	NBT	NBRWBLn1	SBL	SBT
Capacity (veh/h)	-	-	92	732
HCM Lane V/C Ratio	-	-	0.307	0.003
HCM Control Delay (s)	-	-	60.6	9.9
HCM Lane LOS	-	-	F	A
HCM 95th %tile Q(veh)	-	-	1.2	0

Intersection

Int Delay, s/veh 0.3

Movement	EBL	EBT	EBR	WBL	WBT	WBR	NBL	NBT	NBR	SBL	SBT	SBR
Lane Configurations		↔			↔		↑	↑		↑	↑	
Traffic Vol, veh/h	5	0	2	0	0	0	0	878	0	0	1001	5
Future Vol, veh/h	5	0	2	0	0	0	0	878	0	0	1001	5
Conflicting Peds, #/hr	1	0	0	0	0	1	1	0	1	1	0	1
Sign Control	Stop	Stop	Stop	Stop	Stop	Stop	Free	Free	Free	Free	Free	Free
RT Channelized	-	-	None	-	-	None	-	-	None	-	-	None
Storage Length	-	-	-	-	-	-	65	-	-	50	-	-
Veh in Median Storage, #	-	0	-	-	0	-	-	0	-	-	0	-
Grade, %	-	0	-	-	0	-	-	0	-	-	0	-
Peak Hour Factor	93	93	93	93	93	93	93	93	93	93	93	93
Heavy Vehicles, %	0	0	0	0	0	0	0	6	0	0	4	0
Mvmt Flow	5	0	2	0	0	0	0	944	0	0	1076	5

Major/Minor	Minor2			Minor1			Major1			Major2		
Conflicting Flow All	2025	2025	1080	2025	2028	946	1083	0	0	945	0	0
Stage 1	1080	1080	-	945	945	-	-	-	-	-	-	-
Stage 2	945	945	-	1080	1083	-	-	-	-	-	-	-
Critical Hdwy	7.1	6.5	6.2	7.1	6.5	6.2	4.1	-	-	4.1	-	-
Critical Hdwy Stg 1	6.1	5.5	-	6.1	5.5	-	-	-	-	-	-	-
Critical Hdwy Stg 2	6.1	5.5	-	6.1	5.5	-	-	-	-	-	-	-
Follow-up Hdwy	3.5	4	3.3	3.5	4	3.3	2.2	-	-	2.2	-	-
Pot Cap-1 Maneuver	43	58	268	43	58	320	652	-	-	734	-	-
Stage 1	267	297	-	317	343	-	-	-	-	-	-	-
Stage 2	317	343	-	267	296	-	-	-	-	-	-	-
Platoon blocked, %												
Mov Cap-1 Maneuver	43	58	268	43	58	319	652	-	-	733	-	-
Mov Cap-2 Maneuver	43	58	-	43	58	-	-	-	-	-	-	-
Stage 1	267	297	-	317	343	-	-	-	-	-	-	-
Stage 2	317	343	-	265	296	-	-	-	-	-	-	-

Approach	EB	WB	NB	SB
HCM Control Delay, s	77.5	0	0	0
HCM LOS	F	A		

Minor Lane/Major Mvmt	NBL	NBT	NBR	EBLn1WBLn1	SBL	SBT	SBR
Capacity (veh/h)	652	-	-	57	-	733	-
HCM Lane V/C Ratio	-	-	-	0.132	-	-	-
HCM Control Delay (s)	0	-	-	77.5	0	0	-
HCM Lane LOS	A	-	-	F	A	A	-
HCM 95th %tile Q(veh)	0	-	-	0.4	-	0	-

Intersection

Int Delay, s/veh 1.2

Movement	WBL	WBR	NBT	NBR	SBL	SBT
Lane Configurations	↘		↗		↘	↗
Traffic Vol, veh/h	14	42	809	4	10	980
Future Vol, veh/h	14	42	809	4	10	980
Conflicting Peds, #/hr	0	0	0	0	0	0
Sign Control	Stop	Stop	Free	Free	Free	Free
RT Channelized	-	None	-	None	-	None
Storage Length	0	-	-	-	65	-
Veh in Median Storage, #	0	-	0	-	-	0
Grade, %	0	-	0	-	-	0
Peak Hour Factor	92	92	92	92	92	92
Heavy Vehicles, %	0	0	6	0	0	4
Mvmt Flow	15	46	879	4	11	1065

Major/Minor	Minor1		Major1		Major2	
Conflicting Flow All	1969	882	0	0	884	0
Stage 1	882	-	-	-	-	-
Stage 2	1087	-	-	-	-	-
Critical Hdwy	6.4	6.2	-	-	4.1	-
Critical Hdwy Stg 1	5.4	-	-	-	-	-
Critical Hdwy Stg 2	5.4	-	-	-	-	-
Follow-up Hdwy	3.5	3.3	-	-	2.2	-
Pot Cap-1 Maneuver	70	348	-	-	774	-
Stage 1	408	-	-	-	-	-
Stage 2	326	-	-	-	-	-
Platoon blocked, %			-	-		
Mov Cap-1 Maneuver	69	348	-	-	774	-
Mov Cap-2 Maneuver	69	-	-	-	-	-
Stage 1	408	-	-	-	-	-
Stage 2	321	-	-	-	-	-

Approach	WB		NB		SB
HCM Control Delay, s	36.7		0		0.1
HCM LOS	E				

Minor Lane/Major Mvmt	NBT	NBRWBLn1	SBL	SBT
Capacity (veh/h)	-	- 173	774	-
HCM Lane V/C Ratio	-	- 0.352	0.014	-
HCM Control Delay (s)	-	- 36.7	9.7	-
HCM Lane LOS	-	- E	A	-
HCM 95th %tile Q(veh)	-	- 1.5	0	-

Intersection						
Int Delay, s/veh	7.4					
Movement	WBL	WBR	NBT	NBR	SBL	SBT
Lane Configurations	Y		T			T
Traffic Vol, veh/h	2	26	2	0	6	2
Future Vol, veh/h	2	26	2	0	6	2
Conflicting Peds, #/hr	0	0	0	0	0	0
Sign Control	Stop	Stop	Free	Free	Free	Free
RT Channelized	-	None	-	None	-	None
Storage Length	0	-	-	-	-	-
Veh in Median Storage, #	0	-	0	-	-	0
Grade, %	0	-	0	-	-	0
Peak Hour Factor	75	75	75	75	75	75
Heavy Vehicles, %	0	0	0	0	0	0
Mvmt Flow	3	35	3	0	8	3
Major/Minor	Minor1	Major1		Major2		
Conflicting Flow All	22	3	0	0	3	0
Stage 1	3	-	-	-	-	-
Stage 2	19	-	-	-	-	-
Critical Hdwy	6.4	6.2	-	-	4.1	-
Critical Hdwy Stg 1	5.4	-	-	-	-	-
Critical Hdwy Stg 2	5.4	-	-	-	-	-
Follow-up Hdwy	3.5	3.3	-	-	2.2	-
Pot Cap-1 Maneuver	1000	1087	-	-	1632	-
Stage 1	1025	-	-	-	-	-
Stage 2	1009	-	-	-	-	-
Platoon blocked, %			-	-		-
Mov Cap-1 Maneuver	995	1087	-	-	1632	-
Mov Cap-2 Maneuver	995	-	-	-	-	-
Stage 1	1025	-	-	-	-	-
Stage 2	1004	-	-	-	-	-
Approach	WB	NB		SB		
HCM Control Delay, s	8.5	0		5.4		
HCM LOS	A					
Minor Lane/Major Mvmt	NBT	NBRWBLn1	SBL	SBT		
Capacity (veh/h)	-	- 1080	1632	-		
HCM Lane V/C Ratio	-	- 0.035	0.005	-		
HCM Control Delay (s)	-	- 8.5	7.2	0		
HCM Lane LOS	-	- A	A	A		
HCM 95th %tile Q(veh)	-	- 0.1	0	-		

Intersection

Int Delay, s/veh 5.5

Movement	EBT	EBR	WBL	WBT	NBL	NBR
Lane Configurations	↔			↔	↔	
Traffic Vol, veh/h	3	4	0	5	21	0
Future Vol, veh/h	3	4	0	5	21	0
Conflicting Peds, #/hr	0	0	0	0	0	1
Sign Control	Free	Free	Free	Free	Stop	Stop
RT Channelized	-	None	-	None	-	None
Storage Length	-	-	-	-	0	-
Veh in Median Storage, #	0	-	-	0	0	-
Grade, %	0	-	-	0	0	-
Peak Hour Factor	70	70	70	70	70	70
Heavy Vehicles, %	0	0	0	0	0	0
Mvmt Flow	4	6	0	7	30	0

Major/Minor	Major1	Major2	Minor1
Conflicting Flow All	0	10	14
Stage 1	-	-	7
Stage 2	-	-	7
Critical Hdwy	-	4.1	6.4
Critical Hdwy Stg 1	-	-	5.4
Critical Hdwy Stg 2	-	-	5.4
Follow-up Hdwy	-	2.2	3.5
Pot Cap-1 Maneuver	-	1623	1010
Stage 1	-	-	1021
Stage 2	-	-	1021
Platoon blocked, %	-	-	-
Mov Cap-1 Maneuver	-	1621	1010
Mov Cap-2 Maneuver	-	-	1010
Stage 1	-	-	1021
Stage 2	-	-	1021

Approach	EB	WB	NB
HCM Control Delay, s	0	0	8.7
HCM LOS			A

Minor Lane/Major Mvmt	NBLn1	EBT	EBR	WBL	WBT
Capacity (veh/h)	1010	-	-	1621	-
HCM Lane V/C Ratio	0.03	-	-	-	-
HCM Control Delay (s)	8.7	-	-	0	-
HCM Lane LOS	A	-	-	A	-
HCM 95th %tile Q(veh)	0.1	-	-	0	-

Intersection

Int Delay, s/veh 0.9

Movement	EBL	EBT	EBR	WBL	WBT	WBR	NBL	NBT	NBR	SBL	SBT	SBR
Lane Configurations		↕			↕		↕	↕		↕	↕	
Traffic Vol, veh/h	4	0	6	3	0	31	5	760	5	12	965	0
Future Vol, veh/h	4	0	6	3	0	31	5	760	5	12	965	0
Conflicting Peds, #/hr	0	0	0	0	0	0	1	0	0	0	0	1
Sign Control	Stop	Stop	Stop	Stop	Stop	Stop	Free	Free	Free	Free	Free	Free
RT Channelized	-	-	None	-	-	None	-	-	None	-	-	None
Storage Length	-	-	-	-	-	-	125	-	-	125	-	-
Veh in Median Storage, #	-	0	-	-	0	-	-	0	-	-	0	-
Grade, %	-	0	-	-	0	-	-	0	-	-	0	-
Peak Hour Factor	90	90	90	90	90	90	90	90	90	90	90	90
Heavy Vehicles, %	0	0	0	0	0	4	0	6	0	0	4	0
Mvmt Flow	4	0	7	3	0	34	6	844	6	13	1072	0



















Major/Minor	Minor2			Minor1			Major1			Major2		
Conflicting Flow All	1976	1961	1073	1960	1958	847	1073	0	0	850	0	0
Stage 1	1100	1100	-	858	858	-	-	-	-	-	-	-
Stage 2	876	861	-	1102	1100	-	-	-	-	-	-	-
Critical Hdwy	7.1	6.5	6.2	7.1	6.5	6.24	4.1	-	-	4.1	-	-
Critical Hdwy Stg 1	6.1	5.5	-	6.1	5.5	-	-	-	-	-	-	-
Critical Hdwy Stg 2	6.1	5.5	-	6.1	5.5	-	-	-	-	-	-	-
Follow-up Hdwy	3.5	4	3.3	3.5	4	3.336	2.2	-	-	2.2	-	-
Pot Cap-1 Maneuver	47	64	270	48	64	359	657	-	-	797	-	-
Stage 1	260	290	-	354	376	-	-	-	-	-	-	-
Stage 2	346	375	-	259	290	-	-	-	-	-	-	-
Platoon blocked, %												
Mov Cap-1 Maneuver	42	62	270	46	62	359	657	-	-	797	-	-
Mov Cap-2 Maneuver	42	62	-	46	62	-	-	-	-	-	-	-
Stage 1	257	285	-	351	373	-	-	-	-	-	-	-
Stage 2	310	372	-	248	285	-	-	-	-	-	-	-

Approach	EB	WB	NB	SB
HCM Control Delay, s	53.6	24.3	0.1	0.1
HCM LOS	F	C		

Minor Lane/Major Mvmt	NBL	NBT	NBR	EBLn1WBLn1	SBL	SBT	SBR
Capacity (veh/h)	657	-	-	85	224	797	-
HCM Lane V/C Ratio	0.008	-	-	0.131	0.169	0.017	-
HCM Control Delay (s)	10.5	-	-	53.6	24.3	9.6	-
HCM Lane LOS	B	-	-	F	C	A	-
HCM 95th %tile Q(veh)	0	-	-	0.4	0.6	0.1	-

HCM Signalized Intersection Capacity Analysis
7: Highway 1 & California Avenue & Wienke Way

Cumulative plus project, weekday AM

													
Movement	EBL	EBT	EBR	WBL	WBT	WBR2	NBL2	NBL	NBT	NBR	SBL	SBT	
Lane Configurations													
Traffic Volume (vph)	12	0	13	56	0	18	5	9	756	25	7	957	
Future Volume (vph)	12	0	13	56	0	18	5	9	756	25	7	957	
Ideal Flow (vphpl)	1900	1900	1900	1900	1900	1900	1900	1900	1900	1900	1900	1900	
Total Lost time (s)		4.5			4.5			4.5	4.5		4.5	4.5	
Lane Util. Factor		1.00			1.00			1.00	1.00		1.00	1.00	
Frbp, ped/bikes		0.99			1.00			1.00	1.00		1.00	1.00	
Flpb, ped/bikes		1.00			1.00			1.00	1.00		1.00	1.00	
Frt		0.93			0.97			1.00	1.00		1.00	1.00	
Flt Protected		0.98			0.96			0.95	1.00		0.95	1.00	
Satd. Flow (prot)		1673			1734			1770	1854		1770	1861	
Flt Permitted		0.88			0.76			0.15	1.00		0.25	1.00	
Satd. Flow (perm)		1515			1368			288	1854		470	1861	
Peak-hour factor, PHF	0.93	0.93	0.93	0.93	0.93	0.93	0.93	0.92	0.93	0.93	0.93	0.93	
Adj. Flow (vph)	13	0	14	60	0	19	5	10	813	27	8	1029	
RTOR Reduction (vph)	0	24	0	0	39	0	0	0	1	0	0	0	
Lane Group Flow (vph)	0	3	0	0	40	0	0	15	839	0	8	1037	
Confl. Peds. (#/hr)			1	1									
Turn Type	Perm	NA		Perm	NA		Perm	Perm	NA		Perm	NA	
Protected Phases		8			4				6			2	
Permitted Phases	8			4			6	6			2		
Actuated Green, G (s)		10.7			10.7			73.7	73.7		73.7	73.7	
Effective Green, g (s)		10.7			10.7			73.7	73.7		73.7	73.7	
Actuated g/C Ratio		0.10			0.10			0.72	0.72		0.72	0.72	
Clearance Time (s)		4.5			4.5			4.5	4.5		4.5	4.5	
Vehicle Extension (s)		3.0			3.0			3.0	3.0		3.0	3.0	
Lane Grp Cap (vph)		158			142			207	1334		338	1339	
v/s Ratio Prot									0.45			c0.56	
v/s Ratio Perm		0.00			c0.03			0.05			0.02		
v/c Ratio		0.02			0.28			0.07	0.63		0.02	0.77	
Uniform Delay, d1		41.1			42.3			4.2	7.4		4.1	9.1	
Progression Factor		1.00			1.00			1.00	1.00		1.00	1.00	
Incremental Delay, d2		0.0			1.1			0.1	0.9		0.0	2.9	
Delay (s)		41.2			43.4			4.4	8.3		4.1	12.0	
Level of Service		D			D			A	A		A	B	
Approach Delay (s)		41.2			43.4				8.2			11.9	
Approach LOS		D			D				A			B	
Intersection Summary													
HCM 2000 Control Delay			12.2									HCM 2000 Level of Service	B
HCM 2000 Volume to Capacity ratio			0.68										
Actuated Cycle Length (s)			102.4									Sum of lost time (s)	13.5
Intersection Capacity Utilization			73.3%									ICU Level of Service	D
Analysis Period (min)			15										
c Critical Lane Group													

HCM Signalized Intersection Capacity Analysis
 7: Highway 1 & California Avenue & Wienke Way

Cumulative plus project, weekday AM



Movement	SBR	SEL2	SEL	SER
Lane Configurations				
Traffic Volume (vph)	7	4	0	7
Future Volume (vph)	7	4	0	7
Ideal Flow (vphpl)	1900	1900	1900	1900
Total Lost time (s)			4.5	
Lane Util. Factor			1.00	
Frbp, ped/bikes			1.00	
Flpb, ped/bikes			1.00	
Frt			0.91	
Flt Protected			0.98	
Satd. Flow (prot)			1667	
Flt Permitted			0.98	
Satd. Flow (perm)			1667	
Peak-hour factor, PHF	0.93	0.92	0.92	0.92
Adj. Flow (vph)	8	4	0	8
RTOR Reduction (vph)	0	0	0	0
Lane Group Flow (vph)	0	0	12	0
Confl. Peds. (#/hr)				
Turn Type		Perm	Prot	
Protected Phases			9	
Permitted Phases		9		
Actuated Green, G (s)			4.5	
Effective Green, g (s)			4.5	
Actuated g/C Ratio			0.04	
Clearance Time (s)			4.5	
Vehicle Extension (s)			3.0	
Lane Grp Cap (vph)			73	
v/s Ratio Prot				
v/s Ratio Perm			0.01	
v/c Ratio			0.16	
Uniform Delay, d1			47.1	
Progression Factor			1.00	
Incremental Delay, d2			1.1	
Delay (s)			48.2	
Level of Service			D	
Approach Delay (s)			48.2	
Approach LOS			D	
Intersection Summary				

Intersection

Int Delay, s/veh 1.9

Movement	EBL	EBT	EBR	WBL	WBT	WBR	NBL	NBT	NBR	SBL	SBT	SBR
Lane Configurations		↕			↕			↕			↕	
Traffic Vol, veh/h	7	19	0	2	76	0	4	3	0	3	3	4
Future Vol, veh/h	7	19	0	2	76	0	4	3	0	3	3	4
Conflicting Peds, #/hr	1	0	0	0	0	1	0	0	1	1	0	0
Sign Control	Free	Free	Free	Free	Free	Free	Stop	Stop	Stop	Stop	Stop	Stop
RT Channelized	-	-	None	-	-	None	-	-	None	-	-	None
Storage Length	-	-	-	-	-	-	-	-	-	-	-	-
Veh in Median Storage, #	-	0	-	-	0	-	-	0	-	-	0	-
Grade, %	-	0	-	-	0	-	-	0	-	-	0	-
Peak Hour Factor	74	74	74	74	74	74	74	74	74	74	74	74
Heavy Vehicles, %	0	0	0	0	0	0	33	0	0	0	0	0
Mvmt Flow	9	26	0	3	103	0	5	4	0	4	4	5

Major/Minor	Major1			Major2			Minor1			Minor2		
Conflicting Flow All	104	0	0	26	0	0	158	154	27	157	154	104
Stage 1	-	-	-	-	-	-	45	45	-	109	109	-
Stage 2	-	-	-	-	-	-	113	109	-	48	45	-
Critical Hdwy	4.1	-	-	4.1	-	-	7.43	6.5	6.2	7.1	6.5	6.2
Critical Hdwy Stg 1	-	-	-	-	-	-	6.43	5.5	-	6.1	5.5	-
Critical Hdwy Stg 2	-	-	-	-	-	-	6.43	5.5	-	6.1	5.5	-
Follow-up Hdwy	2.2	-	-	2.2	-	-	3.797	4	3.3	3.5	4	3.3
Pot Cap-1 Maneuver	1500	-	-	1601	-	-	743	741	1054	814	741	956
Stage 1	-	-	-	-	-	-	896	861	-	901	809	-
Stage 2	-	-	-	-	-	-	822	809	-	971	861	-
Platoon blocked, %	-	-	-	-	-	-	-	-	-	-	-	-
Mov Cap-1 Maneuver	1500	-	-	1599	-	-	731	734	1053	804	734	955
Mov Cap-2 Maneuver	-	-	-	-	-	-	731	734	-	804	734	-
Stage 1	-	-	-	-	-	-	891	856	-	895	807	-
Stage 2	-	-	-	-	-	-	812	807	-	960	856	-

Approach	EB	WB	NB	SB
HCM Control Delay, s	2	0.2	10	9.4
HCM LOS			B	A

Minor Lane/Major Mvmt	NBLn1	EBL	EBT	EBR	WBL	WBT	WBR	SBLn1
Capacity (veh/h)	732	1500	-	-	1599	-	-	833
HCM Lane V/C Ratio	0.013	0.006	-	-	0.002	-	-	0.016
HCM Control Delay (s)	10	7.4	0	-	7.3	0	-	9.4
HCM Lane LOS	B	A	A	-	A	A	-	A
HCM 95th %tile Q(veh)	0	0	-	-	0	-	-	0

Intersection

Int Delay, s/veh 7.8

Movement	EBL	EBT	EBR	WBL	WBT	WBR	NBL	NBT	NBR	SBL	SBT	SBR
Lane Configurations		↕			↕			↕			↕	
Traffic Vol, veh/h	0	17	0	2	76	11	3	20	0	2	5	0
Future Vol, veh/h	0	17	0	2	76	11	3	20	0	2	5	0
Conflicting Peds, #/hr	1	0	0	0	0	1	0	0	0	0	0	0
Sign Control	Stop	Stop	Stop	Stop	Stop	Stop	Free	Free	Free	Free	Free	Free
RT Channelized	-	-	None	-	-	None	-	-	None	-	-	None
Storage Length	-	-	-	-	-	-	-	-	-	-	-	-
Veh in Median Storage, #	-	0	-	-	0	-	-	0	-	-	0	-
Grade, %	-	0	-	-	0	-	-	0	-	-	0	-
Peak Hour Factor	83	83	83	83	83	83	83	83	83	83	83	83
Heavy Vehicles, %	0	0	0	0	0	0	0	6	0	0	0	0
Mvmt Flow	0	20	0	2	92	13	4	24	0	2	6	0

Major/Minor	Minor2			Minor1			Major1			Major2		
Conflicting Flow All	96	42	6	52	42	25	6	0	0	24	0	0
Stage 1	11	11	-	31	31	-	-	-	-	-	-	-
Stage 2	85	31	-	21	11	-	-	-	-	-	-	-
Critical Hdwy	7.1	6.5	6.2	7.1	6.5	6.2	4.1	-	-	4.1	-	-
Critical Hdwy Stg 1	6.1	5.5	-	6.1	5.5	-	-	-	-	-	-	-
Critical Hdwy Stg 2	6.1	5.5	-	6.1	5.5	-	-	-	-	-	-	-
Follow-up Hdwy	3.5	4	3.3	3.5	4	3.3	2.2	-	-	2.2	-	-
Pot Cap-1 Maneuver	891	854	1083	952	854	1057	1628	-	-	1604	-	-
Stage 1	1015	890	-	991	873	-	-	-	-	-	-	-
Stage 2	928	873	-	1003	890	-	-	-	-	-	-	-
Platoon blocked, %												
Mov Cap-1 Maneuver	805	851	1083	932	851	1056	1628	-	-	1602	-	-
Mov Cap-2 Maneuver	805	851	-	932	851	-	-	-	-	-	-	-
Stage 1	1013	889	-	989	871	-	-	-	-	-	-	-
Stage 2	818	871	-	979	889	-	-	-	-	-	-	-

Approach	EB	WB	NB	SB
HCM Control Delay, s	9.3	9.7	0.9	2.1
HCM LOS	A	A		

Minor Lane/Major Mvmt	NBL	NBT	NBR	EBLn1WBLn1	SBL	SBT	SBR
Capacity (veh/h)	1628	-	-	851	874	1602	-
HCM Lane V/C Ratio	0.002	-	-	0.024	0.123	0.002	-
HCM Control Delay (s)	7.2	0	-	9.3	9.7	7.3	0
HCM Lane LOS	A	A	-	A	A	A	A
HCM 95th %tile Q(veh)	0	-	-	0.1	0.4	0	-

Intersection	
Intersection Delay, s/veh	7.3
Intersection LOS	A

Movement	EBU	EBL	EBT	EBR	WBU	WBL	WBT	WBR	NBU	NBL	NBT	NBR
Lane Configurations			↕				↕				↕	
Traffic Vol, veh/h	0	0	20	2	0	6	73	2	0	2	2	3
Future Vol, veh/h	0	0	20	2	0	6	73	2	0	2	2	3
Peak Hour Factor	0.92	0.90	0.90	0.90	0.92	0.90	0.90	0.90	0.92	0.90	0.90	0.90
Heavy Vehicles, %	2	0	6	0	2	0	0	0	2	0	0	0
Mvmt Flow	0	0	22	2	0	7	81	2	0	2	2	3
Number of Lanes	0	0	1	0	0	0	1	0	0	0	1	0

Approach	EB	WB	NB
Opposing Approach	WB	EB	SB
Opposing Lanes	1	1	1
Conflicting Approach Left	SB	NB	EB
Conflicting Lanes Left	1	1	1
Conflicting Approach Right	NB	SB	WB
Conflicting Lanes Right	1	1	1
HCM Control Delay	7.2	7.4	7
HCM LOS	A	A	A

Lane	NBLn1	EBLn1	WBLn1	SBLn1
Vol Left, %	29%	0%	7%	0%
Vol Thru, %	29%	91%	90%	0%
Vol Right, %	43%	9%	2%	100%
Sign Control	Stop	Stop	Stop	Stop
Traffic Vol by Lane	7	22	81	7
LT Vol	2	0	6	0
Through Vol	2	20	73	0
RT Vol	3	2	2	7
Lane Flow Rate	8	24	90	8
Geometry Grp	1	1	1	1
Degree of Util (X)	0.008	0.027	0.099	0.008
Departure Headway (Hd)	3.904	4.042	3.946	3.504
Convergence, Y/N	Yes	Yes	Yes	Yes
Cap	911	887	912	1014
Service Time	1.952	2.062	1.954	1.551
HCM Lane V/C Ratio	0.009	0.027	0.099	0.008
HCM Control Delay	7	7.2	7.4	6.6
HCM Lane LOS	A	A	A	A
HCM 95th-tile Q	0	0.1	0.3	0

Intersection

Intersection Delay, s/veh

Intersection LOS

Movement	SBU	SBL	SBT	SBR
Lane Configurations			↕	
Traffic Vol, veh/h	0	0	0	7
Future Vol, veh/h	0	0	0	7
Peak Hour Factor	0.92	0.90	0.90	0.90
Heavy Vehicles, %	2	0	0	0
Mvmt Flow	0	0	0	8
Number of Lanes	0	0	1	0

Approach SB

Opposing Approach	NB
Opposing Lanes	1
Conflicting Approach Left	WB
Conflicting Lanes Left	1
Conflicting Approach Right	EB
Conflicting Lanes Right	1
HCM Control Delay	6.6
HCM LOS	A

Intersection

Int Delay, s/veh 1.5

Movement	WBL	WBR	NBT	NBR	SBL	SBT
Lane Configurations	↕		↑	↗		↖
Traffic Vol, veh/h	13	6	1044	21	6	1094
Future Vol, veh/h	13	6	1044	21	6	1094
Conflicting Peds, #/hr	0	0	0	1	1	0
Sign Control	Stop	Stop	Free	Free	Free	Free
RT Channelized	-	None	-	None	-	None
Storage Length	0	-	-	125	-	-
Veh in Median Storage, #	0	-	0	-	-	0
Grade, %	0	-	0	-	-	0
Peak Hour Factor	95	95	95	95	95	95
Heavy Vehicles, %	0	0	2	0	0	2
Mvmt Flow	14	6	1099	22	6	1152

Major/Minor	Minor1		Major1		Major2	
Conflicting Flow All	2264	1100	0	0	1100	0
Stage 1	1100	-	-	-	-	-
Stage 2	1164	-	-	-	-	-
Critical Hdwy	7.1	6.2	-	-	4.1	-
Critical Hdwy Stg 1	6.1	-	-	-	-	-
Critical Hdwy Stg 2	6.1	-	-	-	-	-
Follow-up Hdwy	3.5	3.3	-	-	2.2	-
Pot Cap-1 Maneuver	29	260	-	-	642	-
Stage 1	260	-	-	-	-	-
Stage 2	239	-	-	-	-	-
Platoon blocked, %			-	-		
Mov Cap-1 Maneuver	28	260	-	-	642	-
Mov Cap-2 Maneuver	28	-	-	-	-	-
Stage 1	260	-	-	-	-	-
Stage 2	233	-	-	-	-	-

Approach	WB		NB		SB
HCM Control Delay, s	170.2		0		0.1
HCM LOS	F				

Minor Lane/Major Mvmt	NBT	NBRWBLn1	SBL	SBT
Capacity (veh/h)	-	- 39	642	-
HCM Lane V/C Ratio	-	- 0.513	0.01	-
HCM Control Delay (s)	-	- 170.2	10.7	0
HCM Lane LOS	-	- F	B	A
HCM 95th %tile Q(veh)	-	- 1.8	0	-

Intersection

Int Delay, s/veh 0.8

Movement	EBL	EBT	EBR	WBL	WBT	WBR	NBL	NBT	NBR	SBL	SBT	SBR
Lane Configurations		↔			↔		↑	↑		↑	↑	
Traffic Vol, veh/h	6	0	5	2	0	3	0	1053	0	2	1100	5
Future Vol, veh/h	6	0	5	2	0	3	0	1053	0	2	1100	5
Conflicting Peds, #/hr	5	0	0	0	0	5	0	0	4	4	0	0
Sign Control	Stop	Stop	Stop	Stop	Stop	Stop	Free	Free	Free	Free	Free	Free
RT Channelized	-	-	None	-	-	None	-	-	None	-	-	None
Storage Length	-	-	-	-	-	-	65	-	-	50	-	-
Veh in Median Storage, #	-	0	-	-	0	-	-	0	-	-	0	-
Grade, %	-	0	-	-	0	-	-	0	-	-	0	-
Peak Hour Factor	94	94	94	94	94	94	94	94	94	94	94	94
Heavy Vehicles, %	0	0	0	0	0	0	0	2	0	0	1	0
Mvmt Flow	6	0	5	2	0	3	0	1120	0	2	1170	5

Major/Minor	Minor2			Minor1			Major1			Major2		
Conflicting Flow All	2304	2301	1173	2304	2304	1129	1176	0	0	1124	0	0
Stage 1	1177	1177	-	1124	1124	-	-	-	-	-	-	-
Stage 2	1127	1124	-	1180	1180	-	-	-	-	-	-	-
Critical Hdwy	7.1	6.5	6.2	7.1	6.5	6.2	4.1	-	-	4.1	-	-
Critical Hdwy Stg 1	6.1	5.5	-	6.1	5.5	-	-	-	-	-	-	-
Critical Hdwy Stg 2	6.1	5.5	-	6.1	5.5	-	-	-	-	-	-	-
Follow-up Hdwy	3.5	4	3.3	3.5	4	3.3	2.2	-	-	2.2	-	-
Pot Cap-1 Maneuver	27	39	236	27	39	251	601	-	-	629	-	-
Stage 1	235	267	-	252	283	-	-	-	-	-	-	-
Stage 2	251	283	-	234	266	-	-	-	-	-	-	-
Platoon blocked, %												
Mov Cap-1 Maneuver	26	39	236	26	39	249	601	-	-	626	-	-
Mov Cap-2 Maneuver	26	39	-	26	39	-	-	-	-	-	-	-
Stage 1	235	266	-	251	282	-	-	-	-	-	-	-
Stage 2	247	282	-	228	265	-	-	-	-	-	-	-

Approach	EB	WB	NB	SB
HCM Control Delay, s	114.2	75.9	0	0
HCM LOS	F	F		

Minor Lane/Major Mvmt	NBL	NBT	NBR	EBLn1	WBLn1	SBL	SBT	SBR
Capacity (veh/h)	601	-	-	44	56	626	-	-
HCM Lane V/C Ratio	-	-	-	0.266	0.095	0.003	-	-
HCM Control Delay (s)	0	-	-	114.2	75.9	10.8	-	-
HCM Lane LOS	A	-	-	F	F	B	-	-
HCM 95th %tile Q(veh)	0	-	-	0.9	0.3	0	-	-

Intersection

Int Delay, s/veh 0.9

Movement	WBL	WBR	NBT	NBR	SBL	SBT
Lane Configurations	↘↙		↘		↘	↗
Traffic Vol, veh/h	9	13	1035	13	37	1059
Future Vol, veh/h	9	13	1035	13	37	1059
Conflicting Peds, #/hr	0	0	0	2	2	0
Sign Control	Stop	Stop	Free	Free	Free	Free
RT Channelized	-	None	-	None	-	None
Storage Length	0	-	-	-	65	-
Veh in Median Storage, #	0	-	0	-	-	0
Grade, %	0	-	0	-	-	0
Peak Hour Factor	96	96	96	96	96	96
Heavy Vehicles, %	0	0	2	0	0	2
Mvmt Flow	9	14	1078	14	39	1103

Major/Minor	Minor1		Major1		Major2	
Conflicting Flow All	2267	1087	0	0	1094	0
Stage 1	1087	-	-	-	-	-
Stage 2	1180	-	-	-	-	-
Critical Hdwy	6.4	6.2	-	-	4.1	-
Critical Hdwy Stg 1	5.4	-	-	-	-	-
Critical Hdwy Stg 2	5.4	-	-	-	-	-
Follow-up Hdwy	3.5	3.3	-	-	2.2	-
Pot Cap-1 Maneuver	45	265	-	-	645	-
Stage 1	326	-	-	-	-	-
Stage 2	295	-	-	-	-	-
Platoon blocked, %			-	-		-
Mov Cap-1 Maneuver	42	264	-	-	645	-
Mov Cap-2 Maneuver	42	-	-	-	-	-
Stage 1	325	-	-	-	-	-
Stage 2	277	-	-	-	-	-

Approach	WB		NB		SB
HCM Control Delay, s	64.2		0		0.4
HCM LOS	F				

Minor Lane/Major Mvmt	NBT	NBRWBLn1	SBL	SBT
Capacity (veh/h)	-	- 83	645	-
HCM Lane V/C Ratio	-	- 0.276	0.06	-
HCM Control Delay (s)	-	- 64.2	10.9	-
HCM Lane LOS	-	- F	B	-
HCM 95th %tile Q(veh)	-	- 1	0.2	-

Intersection

Int Delay, s/veh 6.2

Movement	WBL	WBR	NBT	NBR	SBL	SBT
Lane Configurations	Y		P			A
Traffic Vol, veh/h	5	7	2	7	22	0
Future Vol, veh/h	5	7	2	7	22	0
Conflicting Peds, #/hr	1	0	0	5	5	0
Sign Control	Stop	Stop	Free	Free	Free	Free
RT Channelized	-	None	-	None	-	None
Storage Length	0	-	-	-	-	-
Veh in Median Storage, #	0	-	0	-	-	0
Grade, %	0	-	0	-	-	0
Peak Hour Factor	75	75	75	75	75	75
Heavy Vehicles, %	0	17	0	0	0	0
Mvmt Flow	7	9	3	9	29	0

Major/Minor	Minor1		Major1		Major2	
Conflicting Flow All	72	12	0	0	17	0
Stage 1	12	-	-	-	-	-
Stage 2	60	-	-	-	-	-
Critical Hdwy	6.4	6.37	-	-	4.1	-
Critical Hdwy Stg 1	5.4	-	-	-	-	-
Critical Hdwy Stg 2	5.4	-	-	-	-	-
Follow-up Hdwy	3.5	3.453	-	-	2.2	-
Pot Cap-1 Maneuver	937	1027	-	-	1613	-
Stage 1	1016	-	-	-	-	-
Stage 2	968	-	-	-	-	-
Platoon blocked, %			-	-		
Mov Cap-1 Maneuver	915	1022	-	-	1613	-
Mov Cap-2 Maneuver	915	-	-	-	-	-
Stage 1	1011	-	-	-	-	-
Stage 2	950	-	-	-	-	-

Approach	WB		NB		SB
HCM Control Delay, s	8.8		0		7.3
HCM LOS	A				

Minor Lane/Major Mvmt	NBT	NBRWBLn1	SBL	SBT
Capacity (veh/h)	-	-	975	1613
HCM Lane V/C Ratio	-	-	0.016	0.018
HCM Control Delay (s)	-	-	8.8	7.3
HCM Lane LOS	-	-	A	A
HCM 95th %tile Q(veh)	-	-	0.1	0.1

Intersection

Int Delay, s/veh 2.1

Movement	EBT	EBR	WBL	WBT	NBL	NBR
Lane Configurations	↔			↔	↔	
Traffic Vol, veh/h	10	19	2	5	9	0
Future Vol, veh/h	10	19	2	5	9	0
Conflicting Peds, #/hr	0	3	3	0	1	0
Sign Control	Free	Free	Free	Free	Stop	Stop
RT Channelized	-	None	-	None	-	None
Storage Length	-	-	-	-	0	-
Veh in Median Storage, #	0	-	-	0	0	-
Grade, %	0	-	-	0	0	-
Peak Hour Factor	69	69	69	69	69	69
Heavy Vehicles, %	0	0	0	0	29	0
Mvmt Flow	14	28	3	7	13	0

Major/Minor	Major1	Major2	Minor1
Conflicting Flow All	0	45	45
Stage 1	-	-	31
Stage 2	-	-	14
Critical Hdwy	-	4.1	6.69
Critical Hdwy Stg 1	-	-	5.69
Critical Hdwy Stg 2	-	-	5.69
Follow-up Hdwy	-	2.2	3.761
Pot Cap-1 Maneuver	-	1576	901
Stage 1	-	-	926
Stage 2	-	-	943
Platoon blocked, %	-	-	-
Mov Cap-1 Maneuver	-	1576	896
Mov Cap-2 Maneuver	-	-	896
Stage 1	-	-	923
Stage 2	-	-	940

Approach	EB	WB	NB
HCM Control Delay, s	0	2.1	9.1
HCM LOS			A

Minor Lane/Major Mvmt	NBLn1	EBT	EBR	WBL	WBT
Capacity (veh/h)	896	-	-	1576	-
HCM Lane V/C Ratio	0.015	-	-	0.002	-
HCM Control Delay (s)	9.1	-	-	7.3	0
HCM Lane LOS	A	-	-	A	A
HCM 95th %tile Q(veh)	0	-	-	0	-

Intersection

Int Delay, s/veh 2.3

Movement	EBL	EBT	EBR	WBL	WBT	WBR	NBL	NBT	NBR	SBL	SBT	SBR
Lane Configurations		↔			↔		↑	↑		↑	↑	
Traffic Vol, veh/h	9	0	9	9	0	20	12	1014	9	33	999	6
Future Vol, veh/h	9	0	9	9	0	20	12	1014	9	33	999	6
Conflicting Peds, #/hr	0	0	0	0	0	0	0	0	2	2	0	0
Sign Control	Stop	Stop	Stop	Stop	Stop	Stop	Free	Free	Free	Free	Free	Free
RT Channelized	-	-	None	-	-	None	-	-	None	-	-	None
Storage Length	-	-	-	-	-	-	125	-	-	125	-	-
Veh in Median Storage, #	-	0	-	-	0	-	-	0	-	-	0	-
Grade, %	-	0	-	-	0	-	-	0	-	-	0	-
Peak Hour Factor	96	96	96	96	96	96	96	96	96	96	96	96
Heavy Vehicles, %	0	0	0	0	0	0	0	2	14	7	2	0
Mvmt Flow	9	0	9	9	0	21	13	1056	9	34	1041	6

Major/Minor	Minor2			Minor1			Major1			Major2		
Conflicting Flow All	2209	2206	1044	2205	2204	1063	1047	0	0	1068	0	0
Stage 1	1113	1113	-	1088	1088	-	-	-	-	-	-	-
Stage 2	1096	1093	-	1117	1116	-	-	-	-	-	-	-
Critical Hdwy	7.1	6.5	6.2	7.1	6.5	6.2	4.1	-	-	4.17	-	-
Critical Hdwy Stg 1	6.1	5.5	-	6.1	5.5	-	-	-	-	-	-	-
Critical Hdwy Stg 2	6.1	5.5	-	6.1	5.5	-	-	-	-	-	-	-
Follow-up Hdwy	3.5	4	3.3	3.5	4	3.3	2.2	-	-	2.263	-	-
Pot Cap-1 Maneuver	32	45	281	32	45	274	672	-	-	634	-	-
Stage 1	255	286	-	264	294	-	-	-	-	-	-	-
Stage 2	261	293	-	254	285	-	-	-	-	-	-	-
Platoon blocked, %												
Mov Cap-1 Maneuver	28	42	281	29	42	273	672	-	-	634	-	-
Mov Cap-2 Maneuver	28	42	-	29	42	-	-	-	-	-	-	-
Stage 1	250	271	-	258	288	-	-	-	-	-	-	-
Stage 2	236	287	-	232	270	-	-	-	-	-	-	-

Approach	EB	WB	NB	SB
HCM Control Delay, s	112	80.7	0.1	0.3
HCM LOS	F	F		

Minor Lane/Major Mvmt	NBL	NBT	NBR	EBLn1WBLn1	SBL	SBT	SBR
Capacity (veh/h)	672	-	-	51	76	634	-
HCM Lane V/C Ratio	0.019	-	-	0.368	0.397	0.054	-
HCM Control Delay (s)	10.5	-	-	112	80.7	11	-
HCM Lane LOS	B	-	-	F	F	B	-
HCM 95th %tile Q(veh)	0.1	-	-	1.3	1.6	0.2	-

HCM Signalized Intersection Capacity Analysis
7: Highway 1 & California Avenue & Wienke Way

Cumulative Plus Project, Weekday PM

Movement	EBL	EBT	EBR	WBL	WBT	WBR2	NBL2	NBL	NBT	NBR	SBL	SBT	
Lane Configurations													
Traffic Volume (vph)	4	0	4	37	0	16	6	10	1052	49	20	981	
Future Volume (vph)	4	0	4	37	0	16	6	10	1052	49	20	981	
Ideal Flow (vphpl)	1900	1900	1900	1900	1900	1900	1900	1900	1900	1900	1900	1900	
Total Lost time (s)		4.5			4.5			4.5	4.5		4.5	4.5	
Lane Util. Factor		1.00			1.00			1.00	1.00		1.00	1.00	
Frb, ped/bikes		0.99			1.00			1.00	1.00		1.00	1.00	
Flpb, ped/bikes		1.00			1.00			1.00	1.00		1.00	1.00	
Frt		0.93			0.96			1.00	0.99		1.00	1.00	
Flt Protected		0.98			0.97			0.95	1.00		0.95	1.00	
Satd. Flow (prot)		1676			1725			1770	1850		1770	1858	
Flt Permitted		0.91			0.79			0.18	1.00		0.13	1.00	
Satd. Flow (perm)		1555			1404			342	1850		249	1858	
Peak-hour factor, PHF	0.93	0.93	0.93	0.93	0.93	0.93	0.93	0.92	0.93	0.93	0.93	0.93	
Adj. Flow (vph)	4	0	4	40	0	17	6	11	1131	53	22	1055	
RTOR Reduction (vph)	0	7	0	0	41	0	0	0	1	0	0	0	
Lane Group Flow (vph)	0	1	0	0	16	0	0	17	1183	0	22	1070	
Confl. Peds. (#/hr)			1	1			1	1					
Turn Type	Perm	NA		Perm	NA		Perm	Perm	NA		Perm	NA	
Protected Phases		8			4				6			2	
Permitted Phases	8			4			6	6			2		
Actuated Green, G (s)		8.8			8.8			96.8	96.8		96.8	96.8	
Effective Green, g (s)		8.8			8.8			96.8	96.8		96.8	96.8	
Actuated g/C Ratio		0.07			0.07			0.79	0.79		0.79	0.79	
Clearance Time (s)		4.5			4.5			4.5	4.5		4.5	4.5	
Vehicle Extension (s)		3.0			3.0			3.0	3.0		3.0	3.0	
Lane Grp Cap (vph)		111			100			269	1457		196	1463	
v/s Ratio Prot									c0.64			0.58	
v/s Ratio Perm		0.00			c0.01			0.05			0.09		
v/c Ratio		0.01			0.16			0.06	0.81		0.11	0.73	
Uniform Delay, d1		53.0			53.6			2.9	7.7		3.0	6.5	
Progression Factor		1.00			1.00			1.00	1.00		1.00	1.00	
Incremental Delay, d2		0.0			0.8			0.1	3.6		0.3	1.9	
Delay (s)		53.0			54.3			3.0	11.3		3.3	8.5	
Level of Service		D			D			A	B		A	A	
Approach Delay (s)		53.0			54.3				11.1			8.4	
Approach LOS		D			D				B			A	
Intersection Summary													
HCM 2000 Control Delay			11.1									HCM 2000 Level of Service	B
HCM 2000 Volume to Capacity ratio			0.73										
Actuated Cycle Length (s)			122.9									Sum of lost time (s)	13.5
Intersection Capacity Utilization			78.6%									ICU Level of Service	D
Analysis Period (min)			15										
c Critical Lane Group													

HCM Signalized Intersection Capacity Analysis
 7: Highway 1 & California Avenue & Wienke Way

Cumulative Plus Project, Weekday PM



Movement	SBR	SBR2	SEL2	SEL	SER
Lane Configurations					
Traffic Volume (vph)	12	2	2	0	3
Future Volume (vph)	12	2	2	0	3
Ideal Flow (vphpl)	1900	1900	1900	1900	1900
Total Lost time (s)				4.5	
Lane Util. Factor				1.00	
Frbp, ped/bikes				1.00	
Flpb, ped/bikes				1.00	
Frt				0.92	
Flt Protected				0.98	
Satd. Flow (prot)				1678	
Flt Permitted				0.98	
Satd. Flow (perm)				1678	
Peak-hour factor, PHF	0.93	0.92	0.92	0.92	0.92
Adj. Flow (vph)	13	2	2	0	3
RTOR Reduction (vph)	0	0	0	0	0
Lane Group Flow (vph)	0	0	0	5	0
Confl. Peds. (#/hr)	1	1			
Turn Type			Perm	Prot	
Protected Phases				9	
Permitted Phases			9		
Actuated Green, G (s)				3.8	
Effective Green, g (s)				3.8	
Actuated g/C Ratio				0.03	
Clearance Time (s)				4.5	
Vehicle Extension (s)				3.0	
Lane Grp Cap (vph)				51	
v/s Ratio Prot					
v/s Ratio Perm				0.00	
v/c Ratio				0.10	
Uniform Delay, d1				57.9	
Progression Factor				1.00	
Incremental Delay, d2				0.8	
Delay (s)				58.7	
Level of Service				E	
Approach Delay (s)				58.7	
Approach LOS				E	
Intersection Summary					

Intersection

Int Delay, s/veh 4

Movement	EBL	EBT	EBR	WBL	WBT	WBR	NBL	NBT	NBR	SBL	SBT	SBR
Lane Configurations		↕			↕			↕			↕	
Traffic Vol, veh/h	16	41	3	0	40	5	11	9	7	4	10	14
Future Vol, veh/h	16	41	3	0	40	5	11	9	7	4	10	14
Conflicting Peds, #/hr	2	0	1	1	0	2	0	0	0	0	0	0
Sign Control	Free	Free	Free	Free	Free	Free	Stop	Stop	Stop	Stop	Stop	Stop
RT Channelized	-	-	None	-	-	None	-	-	None	-	-	None
Storage Length	-	-	-	-	-	-	-	-	-	-	-	-
Veh in Median Storage, #	-	0	-	-	0	-	-	0	-	-	0	-
Grade, %	-	0	-	-	0	-	-	0	-	-	0	-
Peak Hour Factor	79	79	79	79	79	79	79	79	79	79	79	79
Heavy Vehicles, %	0	3	0	0	0	0	0	0	0	33	0	0
Mvmt Flow	20	52	4	0	51	6	14	11	9	5	13	18

Major/Minor	Major1			Major2			Minor1			Minor2		
Conflicting Flow All	59	0	0	57	0	0	164	154	55	160	153	56
Stage 1	-	-	-	-	-	-	95	95	-	56	56	-
Stage 2	-	-	-	-	-	-	69	59	-	104	97	-
Critical Hdwy	4.1	-	-	4.1	-	-	7.1	6.5	6.2	7.43	6.5	6.2
Critical Hdwy Stg 1	-	-	-	-	-	-	6.1	5.5	-	6.43	5.5	-
Critical Hdwy Stg 2	-	-	-	-	-	-	6.1	5.5	-	6.43	5.5	-
Follow-up Hdwy	2.2	-	-	2.2	-	-	3.5	4	3.3	3.797	4	3.3
Pot Cap-1 Maneuver	1558	-	-	1560	-	-	805	741	1018	741	742	1016
Stage 1	-	-	-	-	-	-	917	820	-	883	852	-
Stage 2	-	-	-	-	-	-	946	850	-	831	819	-
Platoon blocked, %		-	-		-	-						
Mov Cap-1 Maneuver	1558	-	-	1560	-	-	772	729	1017	717	730	1014
Mov Cap-2 Maneuver	-	-	-	-	-	-	772	729	-	717	730	-
Stage 1	-	-	-	-	-	-	904	809	-	870	850	-
Stage 2	-	-	-	-	-	-	916	848	-	802	808	-

Approach	EB	WB	NB	SB
HCM Control Delay, s	2	0	9.7	9.4
HCM LOS			A	A

Minor Lane/Major Mvmt	NBLn1	EBL	EBT	EBR	WBL	WBT	WBR	SBLn1
Capacity (veh/h)	807	1558	-	-	1560	-	-	846
HCM Lane V/C Ratio	0.042	0.013	-	-	-	-	-	0.042
HCM Control Delay (s)	9.7	7.3	0	-	0	-	-	9.4
HCM Lane LOS	A	A	A	-	A	-	-	A
HCM 95th %tile Q(veh)	0.1	0	-	-	0	-	-	0.1

Intersection

Int Delay, s/veh 7.6

Movement	EBL	EBT	EBR	WBL	WBT	WBR	NBL	NBT	NBR	SBL	SBT	SBR
Lane Configurations		↕			↕			↕			↕	
Traffic Vol, veh/h	0	46	4	11	39	3	5	7	6	18	14	3
Future Vol, veh/h	0	46	4	11	39	3	5	7	6	18	14	3
Conflicting Peds, #/hr	3	0	0	0	0	3	3	0	2	2	0	3
Sign Control	Stop	Stop	Stop	Stop	Stop	Stop	Free	Free	Free	Free	Free	Free
RT Channelized	-	-	None	-	-	None	-	-	None	-	-	None
Storage Length	-	-	-	-	-	-	-	-	-	-	-	-
Veh in Median Storage, #	-	0	-	-	0	-	-	0	-	-	0	-
Grade, %	-	0	-	-	0	-	-	0	-	-	0	-
Peak Hour Factor	86	86	86	86	86	86	86	86	86	86	86	86
Heavy Vehicles, %	0	5	0	22	0	0	0	0	0	0	8	0
Mvmt Flow	0	53	5	13	45	3	6	8	7	21	16	3

Major/Minor	Minor2			Minor1			Major1			Major2		
Conflicting Flow All	114	92	21	114	90	17	23	0	0	17	0	0
Stage 1	63	63	-	25	25	-	-	-	-	-	-	-
Stage 2	51	29	-	89	65	-	-	-	-	-	-	-
Critical Hdwy	7.1	6.55	6.2	7.32	6.5	6.2	4.1	-	-	4.1	-	-
Critical Hdwy Stg 1	6.1	5.55	-	6.32	5.5	-	-	-	-	-	-	-
Critical Hdwy Stg 2	6.1	5.55	-	6.32	5.5	-	-	-	-	-	-	-
Follow-up Hdwy	3.5	4.045	3.3	3.698	4	3.3	2.2	-	-	2.2	-	-
Pot Cap-1 Maneuver	868	792	1062	818	804	1068	1605	-	-	1613	-	-
Stage 1	953	837	-	944	878	-	-	-	-	-	-	-
Stage 2	967	865	-	871	845	-	-	-	-	-	-	-
Platoon blocked, %												
Mov Cap-1 Maneuver	812	775	1059	760	787	1063	1605	-	-	1608	-	-
Mov Cap-2 Maneuver	812	775	-	760	787	-	-	-	-	-	-	-
Stage 1	946	824	-	938	873	-	-	-	-	-	-	-
Stage 2	908	860	-	800	832	-	-	-	-	-	-	-

Approach	EB	WB	NB	SB
HCM Control Delay, s	9.9	9.9	2	3.7
HCM LOS	A	A		

Minor Lane/Major Mvmt	NBL	NBT	NBR	EBLn1	WBLn1	SBL	SBT	SBR
Capacity (veh/h)	1605	-	-	792	793	1608	-	-
HCM Lane V/C Ratio	0.004	-	-	0.073	0.078	0.013	-	-
HCM Control Delay (s)	7.3	0	-	9.9	9.9	7.3	0	-
HCM Lane LOS	A	A	-	A	A	A	A	-
HCM 95th %tile Q(veh)	0	-	-	0.2	0.3	0	-	-

Intersection	
Intersection Delay, s/veh	7.4
Intersection LOS	A

Movement	EBU	EBL	EBT	EBR	WBU	WBL	WBT	WBR	NBU	NBL	NBT	NBR
Lane Configurations			↕				↕				↕	
Traffic Vol, veh/h	0	3	62	7	0	2	37	0	0	6	3	4
Future Vol, veh/h	0	3	62	7	0	2	37	0	0	6	3	4
Peak Hour Factor	0.92	0.75	0.75	0.75	0.92	0.75	0.75	0.75	0.92	0.75	0.75	0.75
Heavy Vehicles, %	2	0	4	0	2	0	0	0	2	40	0	0
Mvmt Flow	0	4	83	9	0	3	49	0	0	8	4	5
Number of Lanes	0	0	1	0	0	0	1	0	0	0	1	0

Approach	EB	WB	NB
Opposing Approach	WB	EB	SB
Opposing Lanes	1	1	1
Conflicting Approach Left	SB	NB	EB
Conflicting Lanes Left	1	1	1
Conflicting Approach Right	NB	SB	WB
Conflicting Lanes Right	1	1	1
HCM Control Delay	7.4	7.3	7.9
HCM LOS	A	A	A

Lane	NBLn1	EBLn1	WBLn1	SBLn1
Vol Left, %	46%	4%	5%	0%
Vol Thru, %	23%	86%	95%	0%
Vol Right, %	31%	10%	0%	100%
Sign Control	Stop	Stop	Stop	Stop
Traffic Vol by Lane	13	72	39	5
LT Vol	6	3	2	0
Through Vol	3	62	37	0
RT Vol	4	7	0	5
Lane Flow Rate	17	96	52	7
Geometry Grp	1	1	1	1
Degree of Util (X)	0.023	0.105	0.058	0.007
Departure Headway (Hd)	4.748	3.93	4.023	3.566
Convergence, Y/N	Yes	Yes	Yes	Yes
Cap	749	911	888	991
Service Time	2.811	1.958	2.058	1.634
HCM Lane V/C Ratio	0.023	0.105	0.059	0.007
HCM Control Delay	7.9	7.4	7.3	6.7
HCM Lane LOS	A	A	A	A
HCM 95th-tile Q	0.1	0.4	0.2	0

Intersection				
Intersection Delay, s/veh				
Intersection LOS				
Movement	SBU	SBL	SBT	SBR
Lane Configurations			↕	
Traffic Vol, veh/h	0	0	0	5
Future Vol, veh/h	0	0	0	5
Peak Hour Factor	0.92	0.75	0.75	0.75
Heavy Vehicles, %	2	0	0	0
Mvmt Flow	0	0	0	7
Number of Lanes	0	0	1	0
Approach			SB	
Opposing Approach			NB	
Opposing Lanes			1	
Conflicting Approach Left			WB	
Conflicting Lanes Left			1	
Conflicting Approach Right			EB	
Conflicting Lanes Right			1	
HCM Control Delay			6.7	
HCM LOS			A	

Intersection

Int Delay, s/veh 0.4

Movement	WBL	WBR	NBT	NBR	SBL	SBT
Lane Configurations	↕		↑	↗		↖
Traffic Vol, veh/h	9	4	1016	11	5	968
Future Vol, veh/h	9	4	1016	11	5	968
Conflicting Peds, #/hr	0	0	0	1	1	0
Sign Control	Stop	Stop	Free	Free	Free	Free
RT Channelized	-	None	-	None	-	None
Storage Length	0	-	-	125	-	-
Veh in Median Storage, #	0	-	0	-	-	0
Grade, %	0	-	0	-	-	0
Peak Hour Factor	96	96	96	96	96	96
Heavy Vehicles, %	0	0	2	0	0	1
Mvmt Flow	9	4	1058	11	5	1008

Major/Minor	Minor1		Major1		Major2	
Conflicting Flow All	2078	1059	0	0	1059	0
Stage 1	1059	-	-	-	-	-
Stage 2	1019	-	-	-	-	-
Critical Hdwy	6.4	6.2	-	-	4.1	-
Critical Hdwy Stg 1	5.4	-	-	-	-	-
Critical Hdwy Stg 2	5.4	-	-	-	-	-
Follow-up Hdwy	3.5	3.3	-	-	2.2	-
Pot Cap-1 Maneuver	60	275	-	-	665	-
Stage 1	336	-	-	-	-	-
Stage 2	351	-	-	-	-	-
Platoon blocked, %			-	-		
Mov Cap-1 Maneuver	59	275	-	-	665	-
Mov Cap-2 Maneuver	59	-	-	-	-	-
Stage 1	336	-	-	-	-	-
Stage 2	345	-	-	-	-	-

Approach	WB		NB		SB
HCM Control Delay, s	60.6		0		0.1
HCM LOS	F				

Minor Lane/Major Mvmt	NBT	NBRWBLn1	SBL	SBT
Capacity (veh/h)	-	-	78	665
HCM Lane V/C Ratio	-	-	0.174	0.008
HCM Control Delay (s)	-	-	60.6	10.5
HCM Lane LOS	-	-	F	B
HCM 95th %tile Q(veh)	-	-	0.6	0

Intersection

Int Delay, s/veh 0.1

Movement	EBL	EBT	EBR	WBL	WBT	WBR	NBL	NBT	NBR	SBL	SBT	SBR
Lane Configurations		↔			↔		↑	↑		↑	↑	
Traffic Vol, veh/h	0	0	0	2	0	2	3	1013	0	2	977	5
Future Vol, veh/h	0	0	0	2	0	2	3	1013	0	2	977	5
Conflicting Peds, #/hr	0	0	1	1	0	0	0	0	3	3	0	0
Sign Control	Stop	Stop	Stop	Stop	Stop	Stop	Free	Free	Free	Free	Free	Free
RT Channelized	-	-	None	-	-	None	-	-	None	-	-	None
Storage Length	-	-	-	-	-	-	65	-	-	50	-	-
Veh in Median Storage, #	-	0	-	-	0	-	-	0	-	-	0	-
Grade, %	-	0	-	-	0	-	-	0	-	-	0	-
Peak Hour Factor	96	96	96	96	96	96	96	96	96	96	96	96
Heavy Vehicles, %	0	0	0	0	0	0	0	3	0	0	2	0
Mvmt Flow	0	0	0	2	0	2	3	1055	0	2	1018	5

Major/Minor	Minor2			Minor1			Major1			Major2		
Conflicting Flow All	2087	2088	1021	2089	2091	1058	1023	0	0	1058	0	0
Stage 1	1024	1024	-	1064	1064	-	-	-	-	-	-	-
Stage 2	1063	1064	-	1025	1027	-	-	-	-	-	-	-
Critical Hdwy	7.1	6.5	6.2	7.1	6.5	6.2	4.1	-	-	4.1	-	-
Critical Hdwy Stg 1	6.1	5.5	-	6.1	5.5	-	-	-	-	-	-	-
Critical Hdwy Stg 2	6.1	5.5	-	6.1	5.5	-	-	-	-	-	-	-
Follow-up Hdwy	3.5	4	3.3	3.5	4	3.3	2.2	-	-	2.2	-	-
Pot Cap-1 Maneuver	39	53	289	39	53	276	686	-	-	666	-	-
Stage 1	286	315	-	272	302	-	-	-	-	-	-	-
Stage 2	272	302	-	286	314	-	-	-	-	-	-	-
Platoon blocked, %												
Mov Cap-1 Maneuver	38	52	289	39	52	275	685	-	-	666	-	-
Mov Cap-2 Maneuver	38	52	-	39	52	-	-	-	-	-	-	-
Stage 1	285	314	-	270	300	-	-	-	-	-	-	-
Stage 2	269	300	-	285	313	-	-	-	-	-	-	-

Approach	EB	WB	NB	SB
HCM Control Delay, s	0	61.4	0	0
HCM LOS	A	F		

Minor Lane/Major Mvmt	NBL	NBT	NBR	EBLn1WBLn1	SBL	SBT	SBR
Capacity (veh/h)	685	-	-	-	68	666	-
HCM Lane V/C Ratio	0.005	-	-	-	0.061	0.003	-
HCM Control Delay (s)	10.3	-	-	0	61.4	10.4	-
HCM Lane LOS	B	-	-	A	F	B	-
HCM 95th %tile Q(veh)	0	-	-	-	0.2	0	-

Intersection

Int Delay, s/veh 0.9

Movement	WBL	WBR	NBT	NBR	SBL	SBT
Lane Configurations	↘↙		↘		↘	↗
Traffic Vol, veh/h	10	21	987	8	21	958
Future Vol, veh/h	10	21	987	8	21	958
Conflicting Peds, #/hr	0	0	0	1	1	0
Sign Control	Stop	Stop	Free	Free	Free	Free
RT Channelized	-	None	-	None	-	None
Storage Length	0	-	-	-	65	-
Veh in Median Storage, #	0	-	0	-	-	0
Grade, %	0	-	0	-	-	0
Peak Hour Factor	93	93	93	93	93	93
Heavy Vehicles, %	0	9	2	0	0	1
Mvmt Flow	11	23	1061	9	23	1030

Major/Minor	Minor1		Major1		Major2	
Conflicting Flow All	2142	1067	0	0	1071	0
Stage 1	1067	-	-	-	-	-
Stage 2	1075	-	-	-	-	-
Critical Hdwy	6.4	6.29	-	-	4.1	-
Critical Hdwy Stg 1	5.4	-	-	-	-	-
Critical Hdwy Stg 2	5.4	-	-	-	-	-
Follow-up Hdwy	3.5	3.381	-	-	2.2	-
Pot Cap-1 Maneuver	54	261	-	-	658	-
Stage 1	334	-	-	-	-	-
Stage 2	331	-	-	-	-	-
Platoon blocked, %			-	-		
Mov Cap-1 Maneuver	52	261	-	-	658	-
Mov Cap-2 Maneuver	52	-	-	-	-	-
Stage 1	334	-	-	-	-	-
Stage 2	319	-	-	-	-	-

Approach	WB		NB		SB
HCM Control Delay, s	49.1		0		0.2
HCM LOS	E				

Minor Lane/Major Mvmt	NBT	NBRWBLn1	SBL	SBT
Capacity (veh/h)	-	- 114	658	-
HCM Lane V/C Ratio	-	- 0.292	0.034	-
HCM Control Delay (s)	-	- 49.1	10.7	-
HCM Lane LOS	-	- E	B	-
HCM 95th %tile Q(veh)	-	- 1.1	0.1	-

Intersection						
Int Delay, s/veh	6.4					
Movement	WBL	WBR	NBT	NBR	SBL	SBT
Lane Configurations	Y		P			A
Traffic Vol, veh/h	4	16	2	3	7	3
Future Vol, veh/h	4	16	2	3	7	3
Conflicting Peds, #/hr	2	0	0	0	0	0
Sign Control	Stop	Stop	Free	Free	Free	Free
RT Channelized	-	None	-	None	-	None
Storage Length	0	-	-	-	-	-
Veh in Median Storage, #	0	-	0	-	-	0
Grade, %	0	-	0	-	-	0
Peak Hour Factor	75	75	75	75	75	75
Heavy Vehicles, %	33	8	0	0	0	0
Mvmt Flow	5	21	3	4	9	4
Major/Minor	Minor1		Major1		Major2	
Conflicting Flow All	30	5	0	0	7	0
Stage 1	5	-	-	-	-	-
Stage 2	25	-	-	-	-	-
Critical Hdwy	6.73	6.28	-	-	4.1	-
Critical Hdwy Stg 1	5.73	-	-	-	-	-
Critical Hdwy Stg 2	5.73	-	-	-	-	-
Follow-up Hdwy	3.797	3.372	-	-	2.2	-
Pot Cap-1 Maneuver	911	1061	-	-	1627	-
Stage 1	943	-	-	-	-	-
Stage 2	923	-	-	-	-	-
Platoon blocked, %			-	-		
Mov Cap-1 Maneuver	904	1061	-	-	1627	-
Mov Cap-2 Maneuver	904	-	-	-	-	-
Stage 1	943	-	-	-	-	-
Stage 2	916	-	-	-	-	-
Approach	WB		NB		SB	
HCM Control Delay, s	8.6		0		5.1	
HCM LOS	A					
Minor Lane/Major Mvmt	NBT	NBRWBLn1	SBL	SBT		
Capacity (veh/h)	-	- 1025	1627	-		
HCM Lane V/C Ratio	-	- 0.026	0.006	-		
HCM Control Delay (s)	-	- 8.6	7.2	0		
HCM Lane LOS	-	- A	A	A		
HCM 95th %tile Q(veh)	-	- 0.1	0	-		

Intersection						
Int Delay, s/veh	6					
Movement	EBT	EBR	WBL	WBT	NBL	NBR
Lane Configurations	↔		↔		↔	
Traffic Vol, veh/h	3	6	2	0	16	2
Future Vol, veh/h	3	6	2	0	16	2
Conflicting Peds, #/hr	0	1	1	0	0	0
Sign Control	Free	Free	Free	Free	Stop	Stop
RT Channelized	-	None	-	None	-	None
Storage Length	-	-	-	-	0	-
Veh in Median Storage, #	0	-	-	0	0	-
Grade, %	0	-	-	0	0	-
Peak Hour Factor	79	79	79	79	79	79
Heavy Vehicles, %	0	0	100	0	15	0
Mvmt Flow	4	8	3	0	20	3
Major/Minor	Major1		Major2		Minor1	
Conflicting Flow All	0	0	12	0	14	9
Stage 1	-	-	-	-	9	-
Stage 2	-	-	-	-	5	-
Critical Hdwy	-	-	5.1	-	6.55	6.2
Critical Hdwy Stg 1	-	-	-	-	5.55	-
Critical Hdwy Stg 2	-	-	-	-	5.55	-
Follow-up Hdwy	-	-	3.1	-	3.635	3.3
Pot Cap-1 Maneuver	-	-	1148	-	972	1079
Stage 1	-	-	-	-	981	-
Stage 2	-	-	-	-	985	-
Platoon blocked, %	-	-	-	-	-	-
Mov Cap-1 Maneuver	-	-	1148	-	968	1078
Mov Cap-2 Maneuver	-	-	-	-	968	-
Stage 1	-	-	-	-	980	-
Stage 2	-	-	-	-	982	-
Approach	EB		WB		NB	
HCM Control Delay, s	0		8.1		8.8	
HCM LOS					A	
Minor Lane/Major Mvmt	NBLn1	EBT	EBR	WBL	WBT	
Capacity (veh/h)	979	-	-	1148	-	
HCM Lane V/C Ratio	0.023	-	-	0.002	-	
HCM Control Delay (s)	8.8	-	-	8.1	0	
HCM Lane LOS	A	-	-	A	A	
HCM 95th %tile Q(veh)	0.1	-	-	0	-	

Intersection

Int Delay, s/veh 1.1

Movement	EBL	EBT	EBR	WBL	WBT	WBR	NBL	NBT	NBR	SBL	SBT	SBR
Lane Configurations		↕			↕		↕	↕		↕	↕	
Traffic Vol, veh/h	0	0	7	7	2	29	11	721	3	26	938	6
Future Vol, veh/h	0	0	7	7	2	29	11	721	3	26	938	6
Conflicting Peds, #/hr	0	0	0	0	0	0	0	0	1	1	0	0
Sign Control	Stop	Stop	Stop	Stop	Stop	Stop	Free	Free	Free	Free	Free	Free
RT Channelized	-	-	None	-	-	None	-	-	None	-	-	None
Storage Length	-	-	-	-	-	-	125	-	-	125	-	-
Veh in Median Storage, #	-	0	-	-	0	-	-	0	-	-	0	-
Grade, %	-	0	-	-	0	-	-	0	-	-	0	-
Peak Hour Factor	95	95	95	95	95	95	95	95	95	95	95	95
Heavy Vehicles, %	0	0	0	17	0	4	0	3	0	5	1	0
Mvmt Flow	0	0	7	7	2	31	12	759	3	27	987	6



















Major/Minor	Minor2			Minor1			Major1			Major2		
Conflicting Flow All	1845	1831	991	1834	1833	762	994	0	0	763	0	0
Stage 1	1045	1045	-	785	785	-	-	-	-	-	-	-
Stage 2	800	786	-	1049	1048	-	-	-	-	-	-	-
Critical Hdwy	7.1	6.5	6.2	7.27	6.5	6.24	4.1	-	-	4.15	-	-
Critical Hdwy Stg 1	6.1	5.5	-	6.27	5.5	-	-	-	-	-	-	-
Critical Hdwy Stg 2	6.1	5.5	-	6.27	5.5	-	-	-	-	-	-	-
Follow-up Hdwy	3.5	4	3.3	3.653	4	3.336	2.2	-	-	2.245	-	-
Pot Cap-1 Maneuver	58	77	301	53	77	402	704	-	-	836	-	-
Stage 1	279	308	-	364	407	-	-	-	-	-	-	-
Stage 2	382	406	-	258	307	-	-	-	-	-	-	-
Platoon blocked, %												
Mov Cap-1 Maneuver	50	73	301	50	73	402	704	-	-	836	-	-
Mov Cap-2 Maneuver	50	73	-	50	73	-	-	-	-	-	-	-
Stage 1	274	298	-	357	400	-	-	-	-	-	-	-
Stage 2	345	399	-	244	297	-	-	-	-	-	-	-

Approach	EB	WB	NB	SB
HCM Control Delay, s	17.3	35.1	0.2	0.3
HCM LOS	C	E		

Minor Lane/Major Mvmt	NBL	NBT	NBR	EBLn1WBLn1	SBL	SBT	SBR
Capacity (veh/h)	704	-	-	301	159	836	-
HCM Lane V/C Ratio	0.016	-	-	0.024	0.252	0.033	-
HCM Control Delay (s)	10.2	-	-	17.3	35.1	9.5	-
HCM Lane LOS	B	-	-	C	E	A	-
HCM 95th %tile Q(veh)	0.1	-	-	0.1	0.9	0.1	-

HCM Signalized Intersection Capacity Analysis
7: Highway 1 & California Avenue & Wienke Way

Cumulative plus project, weekend midday

												
Movement	EBL	EBT	EBR	WBL	WBT	WBR2	NBL2	NBL	NBT	NBR	SBL	SBT
Lane Configurations												
Traffic Volume (vph)	7	4	25	27	4	27	33	5	705	42	9	938
Future Volume (vph)	7	4	25	27	4	27	33	5	705	42	9	938
Ideal Flow (vphpl)	1900	1900	1900	1900	1900	1900	1900	1900	1900	1900	1900	1900
Total Lost time (s)		4.5			4.5			4.5	4.5		4.5	4.5
Lane Util. Factor		1.00			1.00			1.00	1.00		1.00	1.00
Flt		0.91			0.94			1.00	0.99		1.00	1.00
Flt Protected		0.99			0.98			0.95	1.00		0.95	1.00
Satd. Flow (prot)		1672			1705			1770	1847		1770	1858
Flt Permitted		0.95			0.87			0.18	1.00		0.28	1.00
Satd. Flow (perm)		1603			1510			329	1847		527	1858
Peak-hour factor, PHF	0.93	0.93	0.93	0.93	0.93	0.93	0.93	0.92	0.93	0.93	0.93	0.93
Adj. Flow (vph)	8	4	27	29	4	29	35	5	758	45	10	1009
RTOR Reduction (vph)	0	25	0	0	40	0	0	0	1	0	0	0
Lane Group Flow (vph)	0	14	0	0	22	0	0	40	802	0	10	1026
Turn Type	Perm	NA		Perm	NA		Perm	Perm	NA		Perm	NA
Protected Phases		8			4				6			2
Permitted Phases	8			4			6	6			2	
Actuated Green, G (s)		8.1			8.1			75.2	75.2		75.2	75.2
Effective Green, g (s)		8.1			8.1			75.2	75.2		75.2	75.2
Actuated g/C Ratio		0.08			0.08			0.74	0.74		0.74	0.74
Clearance Time (s)		4.5			4.5			4.5	4.5		4.5	4.5
Vehicle Extension (s)		3.0			3.0			3.0	3.0		3.0	3.0
Lane Grp Cap (vph)		128			120			244	1372		391	1380
v/s Ratio Prot									0.43			c0.55
v/s Ratio Perm		0.01			c0.01			0.12			0.02	
v/c Ratio		0.11			0.18			0.16	0.58		0.03	0.74
Uniform Delay, d1		43.2			43.4			3.8	5.9		3.4	7.5
Progression Factor		1.00			1.00			1.00	1.00		1.00	1.00
Incremental Delay, d2		0.4			0.7			0.3	0.6		0.0	2.2
Delay (s)		43.6			44.2			4.1	6.5		3.4	9.7
Level of Service		D			D			A	A		A	A
Approach Delay (s)		43.6			44.2				6.4			9.6
Approach LOS		D			D				A			A

Intersection Summary

HCM 2000 Control Delay	10.3	HCM 2000 Level of Service	B
HCM 2000 Volume to Capacity ratio	0.66		
Actuated Cycle Length (s)	101.2	Sum of lost time (s)	13.5
Intersection Capacity Utilization	72.7%	ICU Level of Service	C
Analysis Period (min)	15		

c Critical Lane Group

HCM Signalized Intersection Capacity Analysis
 7: Highway 1 & California Avenue & Wienke Way

Cumulative plus project, weekend midday



Movement	SBR	SBR2	SEL2	SEL	SER
Lane Configurations					
Traffic Volume (vph)	9	6	4	0	10
Future Volume (vph)	9	6	4	0	10
Ideal Flow (vphpl)	1900	1900	1900	1900	1900
Total Lost time (s)				4.5	
Lane Util. Factor				1.00	
Flt				0.90	
Flt Protected				0.99	
Satd. Flow (prot)				1656	
Flt Permitted				0.99	
Satd. Flow (perm)				1656	
Peak-hour factor, PHF	0.93	0.92	0.92	0.92	0.92
Adj. Flow (vph)	10	7	4	0	11
RTOR Reduction (vph)	0	0	0	0	0
Lane Group Flow (vph)	0	0	0	15	0
Turn Type			Perm	Prot	
Protected Phases				9	
Permitted Phases			9		
Actuated Green, G (s)				4.4	
Effective Green, g (s)				4.4	
Actuated g/C Ratio				0.04	
Clearance Time (s)				4.5	
Vehicle Extension (s)				3.0	
Lane Grp Cap (vph)				72	
v/s Ratio Prot					
v/s Ratio Perm				0.01	
v/c Ratio				0.21	
Uniform Delay, d1				46.7	
Progression Factor				1.00	
Incremental Delay, d2				1.4	
Delay (s)				48.2	
Level of Service				D	
Approach Delay (s)				48.2	
Approach LOS				D	
Intersection Summary					

Intersection

Int Delay, s/veh 4.6

Movement	EBL	EBT	EBR	WBL	WBT	WBR	NBL	NBT	NBR	SBL	SBT	SBR
Lane Configurations		↕			↕			↕			↕	
Traffic Vol, veh/h	29	39	3	6	36	20	12	11	4	7	20	10
Future Vol, veh/h	29	39	3	6	36	20	12	11	4	7	20	10
Conflicting Peds, #/hr	1	0	0	0	0	1	0	0	2	2	0	0
Sign Control	Free	Free	Free	Free	Free	Free	Stop	Stop	Stop	Stop	Stop	Stop
RT Channelized	-	-	None	-	-	None	-	-	None	-	-	None
Storage Length	-	-	-	-	-	-	-	-	-	-	-	-
Veh in Median Storage, #	-	0	-	-	0	-	-	0	-	-	0	-
Grade, %	-	0	-	-	0	-	-	0	-	-	0	-
Peak Hour Factor	83	83	83	83	83	83	83	83	83	83	83	83
Heavy Vehicles, %	0	0	0	0	0	0	0	0	0	0	0	0
Mvmt Flow	35	47	4	7	43	24	14	13	5	8	24	12

Major/Minor	Major1			Major2			Minor1			Minor2		
Conflicting Flow All	68	0	0	51	0	0	207	202	51	201	191	56
Stage 1	-	-	-	-	-	-	119	119	-	71	71	-
Stage 2	-	-	-	-	-	-	88	83	-	130	120	-
Critical Hdwy	4.1	-	-	4.1	-	-	7.1	6.5	6.2	7.1	6.5	6.2
Critical Hdwy Stg 1	-	-	-	-	-	-	6.1	5.5	-	6.1	5.5	-
Critical Hdwy Stg 2	-	-	-	-	-	-	6.1	5.5	-	6.1	5.5	-
Follow-up Hdwy	2.2	-	-	2.2	-	-	3.5	4	3.3	3.5	4	3.3
Pot Cap-1 Maneuver	1546	-	-	1568	-	-	755	698	1023	762	708	1016
Stage 1	-	-	-	-	-	-	890	801	-	944	840	-
Stage 2	-	-	-	-	-	-	925	830	-	878	800	-
Platoon blocked, %	-	-	-	-	-	-	-	-	-	-	-	-
Mov Cap-1 Maneuver	1546	-	-	1565	-	-	711	678	1021	729	688	1015
Mov Cap-2 Maneuver	-	-	-	-	-	-	711	678	-	729	688	-
Stage 1	-	-	-	-	-	-	870	783	-	921	835	-
Stage 2	-	-	-	-	-	-	883	825	-	838	782	-

Approach	EB	WB	NB	SB
HCM Control Delay, s	3	0.7	10.2	10
HCM LOS			B	B

Minor Lane/Major Mvmt	NBLn1	EBL	EBT	EBR	WBL	WBT	WBR	SBLn1
Capacity (veh/h)	729	1546	-	-	1565	-	-	763
HCM Lane V/C Ratio	0.045	0.023	-	-	0.005	-	-	0.058
HCM Control Delay (s)	10.2	7.4	0	-	7.3	0	-	10
HCM Lane LOS	B	A	A	-	A	A	-	B
HCM 95th %tile Q(veh)	0.1	0.1	-	-	0	-	-	0.2

Intersection

Int Delay, s/veh 6.9

Movement	EBL	EBT	EBR	WBL	WBT	WBR	NBL	NBT	NBR	SBL	SBT	SBR
Lane Configurations		↕			↕			↕			↕	
Traffic Vol, veh/h	3	43	4	12	43	3	9	16	9	10	19	4
Future Vol, veh/h	3	43	4	12	43	3	9	16	9	10	19	4
Conflicting Peds, #/hr	4	0	0	0	0	4	1	0	1	1	0	1
Sign Control	Stop	Stop	Stop	Stop	Stop	Stop	Free	Free	Free	Free	Free	Free
RT Channelized	-	-	None	-	-	None	-	-	None	-	-	None
Storage Length	-	-	-	-	-	-	-	-	-	-	-	-
Veh in Median Storage, #	-	0	-	-	0	-	-	0	-	-	0	-
Grade, %	-	0	-	-	0	-	-	0	-	-	0	-
Peak Hour Factor	84	84	84	84	84	84	84	84	84	84	84	84
Heavy Vehicles, %	0	0	0	0	0	0	0	8	14	0	6	0
Mvmt Flow	4	51	5	14	51	4	11	19	11	12	23	5

Major/Minor	Minor2			Minor1			Major1			Major2		
Conflicting Flow All	127	102	26	124	99	29	28	0	0	31	0	0
Stage 1	50	50	-	47	47	-	-	-	-	-	-	-
Stage 2	77	52	-	77	52	-	-	-	-	-	-	-
Critical Hdwy	7.1	6.5	6.2	7.1	6.5	6.2	4.1	-	-	4.1	-	-
Critical Hdwy Stg 1	6.1	5.5	-	6.1	5.5	-	-	-	-	-	-	-
Critical Hdwy Stg 2	6.1	5.5	-	6.1	5.5	-	-	-	-	-	-	-
Follow-up Hdwy	3.5	4	3.3	3.5	4	3.3	2.2	-	-	2.2	-	-
Pot Cap-1 Maneuver	851	792	1056	855	795	1052	1599	-	-	1595	-	-
Stage 1	968	857	-	972	860	-	-	-	-	-	-	-
Stage 2	937	856	-	937	856	-	-	-	-	-	-	-
Platoon blocked, %												
Mov Cap-1 Maneuver	793	779	1055	799	782	1047	1599	-	-	1589	-	-
Mov Cap-2 Maneuver	793	779	-	799	782	-	-	-	-	-	-	-
Stage 1	960	849	-	964	853	-	-	-	-	-	-	-
Stage 2	868	849	-	870	848	-	-	-	-	-	-	-

Approach	EB	WB	NB	SB
HCM Control Delay, s	9.9	10	1.9	2.2
HCM LOS	A	B		

Minor Lane/Major Mvmt	NBL	NBT	NBR	EBLn1WBLn1	SBL	SBT	SBR
Capacity (veh/h)	1599	-	-	797	796	1589	-
HCM Lane V/C Ratio	0.007	-	-	0.075	0.087	0.007	-
HCM Control Delay (s)	7.3	0	-	9.9	10	7.3	0
HCM Lane LOS	A	A	-	A	B	A	A
HCM 95th %tile Q(veh)	0	-	-	0.2	0.3	0	-

Intersection	
Intersection Delay, s/veh	7.2
Intersection LOS	A

Movement	EBU	EBL	EBT	EBR	WBU	WBL	WBT	WBR	NBU	NBL	NBT	NBR
Lane Configurations			↕				↕				↕	
Traffic Vol, veh/h	0	5	52	4	0	3	47	0	0	5	2	5
Future Vol, veh/h	0	5	52	4	0	3	47	0	0	5	2	5
Peak Hour Factor	0.92	0.83	0.83	0.83	0.92	0.83	0.83	0.83	0.92	0.83	0.83	0.83
Heavy Vehicles, %	2	0	2	0	2	0	0	0	2	0	0	0
Mvmt Flow	0	6	63	5	0	4	57	0	0	6	2	6
Number of Lanes	0	0	1	0	0	0	1	0	0	0	1	0

Approach	EB	WB	NB
Opposing Approach	WB	EB	SB
Opposing Lanes	1	1	1
Conflicting Approach Left	SB	NB	EB
Conflicting Lanes Left	1	1	1
Conflicting Approach Right	NB	SB	WB
Conflicting Lanes Right	1	1	1
HCM Control Delay	7.3	7.3	7.1
HCM LOS	A	A	A

Lane	NBLn1	EBLn1	WBLn1	SBLn1
Vol Left, %	42%	8%	6%	0%
Vol Thru, %	17%	85%	94%	22%
Vol Right, %	42%	7%	0%	78%
Sign Control	Stop	Stop	Stop	Stop
Traffic Vol by Lane	12	61	50	9
LT Vol	5	5	3	0
Through Vol	2	52	47	2
RT Vol	5	4	0	7
Lane Flow Rate	14	73	60	11
Geometry Grp	1	1	1	1
Degree of Util (X)	0.016	0.081	0.067	0.011
Departure Headway (Hd)	3.973	3.968	4.012	3.675
Convergence, Y/N	Yes	Yes	Yes	Yes
Cap	894	904	893	965
Service Time	2.029	1.986	2.033	1.733
HCM Lane V/C Ratio	0.016	0.081	0.067	0.011
HCM Control Delay	7.1	7.3	7.3	6.8
HCM Lane LOS	A	A	A	A
HCM 95th-tile Q	0	0.3	0.2	0

Intersection				
Intersection Delay, s/veh				
Intersection LOS				
Movement	SBU	SBL	SBT	SBR
Lane Configurations			↕	
Traffic Vol, veh/h	0	0	2	7
Future Vol, veh/h	0	0	2	7
Peak Hour Factor	0.92	0.83	0.83	0.83
Heavy Vehicles, %	2	0	0	0
Mvmt Flow	0	0	2	8
Number of Lanes	0	0	1	0
Approach			SB	
Opposing Approach			NB	
Opposing Lanes			1	
Conflicting Approach Left			WB	
Conflicting Lanes Left			1	
Conflicting Approach Right			EB	
Conflicting Lanes Right			1	
HCM Control Delay			6.8	
HCM LOS			A	

Appendix 10 Existing with Project Conditions, Mitigated Level-of- Service Worksheets

HCM Signalized Intersection Analysis
7: Highway 1 & California Avenue & Wienke Way

Existing plus Project Weekday AM, Mitigated

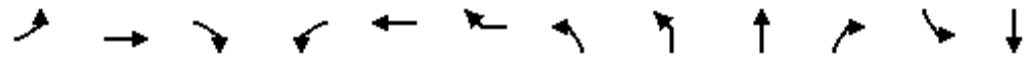

Movement	EBL	EBT	EBR	WBL	WBT	WBR	NBL2	NBL	NBT	NBR	SBL	SBT	
Lane Configurations		↕			↕		↗		↗		↗	↗	
Traffic Volume (vph)	10	0	11	48	0	15	0	4	623	21	6	575	
Future Volume (vph)	10	0	11	48	0	15	0	4	623	21	6	575	
Ideal Flow (vphpl)	1900	1900	1900	1900	1900	1900	1900	1900	1900	1900	1900	1900	
Total Lost time (s)		4.5			4.5				4.5		4.5	4.5	
Lane Util. Factor		1.00			1.00				1.00		1.00	1.00	
Frbp, ped/bikes		1.00			1.00				1.00		1.00	1.00	
Flpb, ped/bikes		1.00			1.00				1.00		1.00	1.00	
Frt		0.93			0.97				1.00		1.00	1.00	
Flt Protected		0.98			0.96				1.00		0.95	1.00	
Satd. Flow (prot)		1691			1737				1853		1770	1860	
Flt Permitted		0.86			0.76				1.00		0.29	1.00	
Satd. Flow (perm)		1485			1373				1849		545	1860	
Peak-hour factor, PHF	0.93	0.93	0.93	0.93	0.93	0.92	0.93	0.92	0.93	0.93	0.93	0.93	
Adj. Flow (vph)	11	0	12	52	0	16	0	4	670	23	6	618	
RTOR Reduction (vph)	0	20	0	0	0	0	0	0	1	0	0	0	
Lane Group Flow (vph)	0	3	0	0	68	0	0	0	696	0	6	624	
Confl. Peds. (#/hr)							1						
Turn Type	Perm	NA		Perm	NA		Perm	Perm	NA		Perm	NA	
Protected Phases		8			4				6			2	
Permitted Phases	8			4			6	6			2		
Actuated Green, G (s)		9.2			9.2				43.2		43.2	43.2	
Effective Green, g (s)		9.2			9.2				43.2		43.2	43.2	
Actuated g/C Ratio		0.13			0.13				0.63		0.63	0.63	
Clearance Time (s)		4.5			4.5				4.5		4.5	4.5	
Vehicle Extension (s)		3.0			3.0				3.0		3.0	3.0	
Lane Grp Cap (vph)		198			183				1162		342	1169	
v/s Ratio Prot												0.34	
v/s Ratio Perm		0.00			c0.05				c0.38		0.01		
v/c Ratio		0.02			0.37				0.60		0.02	0.53	
Uniform Delay, d1		25.8			27.1				7.6		4.8	7.1	
Progression Factor		1.00			1.00				1.00		1.00	1.00	
Incremental Delay, d2		0.0			1.3				0.8		0.0	0.5	
Delay (s)		25.9			28.4				8.4		4.8	7.6	
Level of Service		C			C				A		A	A	
Approach Delay (s)		25.9			28.4				8.4			7.6	
Approach LOS		C			C				A			A	
Intersection Summary													
HCM 2000 Control Delay			9.3									HCM 2000 Level of Service	A
HCM 2000 Volume to Capacity ratio			0.53										
Actuated Cycle Length (s)			68.7									Sum of lost time (s)	13.5
Intersection Capacity Utilization			50.4%									ICU Level of Service	A
Analysis Period (min)			15										
c Critical Lane Group													

7: Highway 1 & California Avenue & Wienke Way



Movement	SBR	SEL
Lane Configurations		
Traffic Volume (vph)	6	0
Future Volume (vph)	6	0
Ideal Flow (vphpl)	1900	1900
Total Lost time (s)		
Lane Util. Factor		
Frbp, ped/bikes		
Flpb, ped/bikes		
Frt		
Flt Protected		
Satd. Flow (prot)		
Flt Permitted		
Satd. Flow (perm)		
Peak-hour factor, PHF	0.93	0.92
Adj. Flow (vph)	6	0
RTOR Reduction (vph)	0	0
Lane Group Flow (vph)	0	0
Confl. Peds. (#/hr)	1	
Turn Type		Prot
Protected Phases		9
Permitted Phases		
Actuated Green, G (s)		
Effective Green, g (s)		
Actuated g/C Ratio		
Clearance Time (s)		
Vehicle Extension (s)		
Lane Grp Cap (vph)		
v/s Ratio Prot		
v/s Ratio Perm		
v/c Ratio		
Uniform Delay, d1		
Progression Factor		
Incremental Delay, d2		
Delay (s)		
Level of Service		
Approach Delay (s)		0.0
Approach LOS		A
Intersection Summary		

HCM Signalized Intersection Analysis
7: Highway 1 & California Avenue & Wienke Way

Existing plus Project Weekday PM, Mitigated

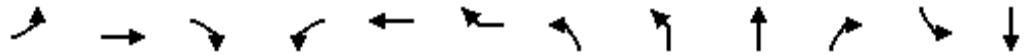

Movement	EBL	EBT	EBR	WBL	WBT	WBR	NBL2	NBL	NBT	NBR	SBL	SBT	
Lane Configurations		↕			↕		↗		↖		↗	↖	
Traffic Volume (vph)	3	0	3	32	0	13	0	5	673	42	17	815	
Future Volume (vph)	3	0	3	32	0	13	0	5	673	42	17	815	
Ideal Flow (vphpl)	1900	1900	1900	1900	1900	1900	1900	1900	1900	1900	1900	1900	
Total Lost time (s)		4.5			4.5				4.5		4.5	4.5	
Lane Util. Factor		1.00			1.00				1.00		1.00	1.00	
Frbp, ped/bikes		1.00			1.00				1.00		1.00	1.00	
Flpb, ped/bikes		1.00			1.00				1.00		1.00	1.00	
Frt		0.93			0.96				0.99		1.00	1.00	
Flt Protected		0.98			0.97				1.00		0.95	1.00	
Satd. Flow (prot)		1693			1729				1846		1770	1859	
Flt Permitted		0.88			0.78				1.00		0.28	1.00	
Satd. Flow (perm)		1534			1405				1839		521	1859	
Peak-hour factor, PHF	0.91	0.91	0.91	0.91	0.91	0.92	0.91	0.92	0.91	0.91	0.91	0.91	
Adj. Flow (vph)	3	0	3	35	0	14	0	5	740	46	19	896	
RTOR Reduction (vph)	0	5	0	0	0	0	0	0	1	0	0	0	
Lane Group Flow (vph)	0	1	0	0	49	0	0	0	790	0	19	907	
Confl. Peds. (#/hr)	1						1						
Turn Type	Perm	NA		Perm	NA		Perm	Perm	NA		Perm	NA	
Protected Phases		8			4				6			2	
Permitted Phases	8			4			6	6			2		
Actuated Green, G (s)		9.5			9.5				67.2		67.2	67.2	
Effective Green, g (s)		9.5			9.5				67.2		67.2	67.2	
Actuated g/C Ratio		0.10			0.10				0.72		0.72	0.72	
Clearance Time (s)		4.5			4.5				4.5		4.5	4.5	
Vehicle Extension (s)		3.0			3.0				3.0		3.0	3.0	
Lane Grp Cap (vph)		156			143				1325		375	1340	
v/s Ratio Prot												c0.49	
v/s Ratio Perm		0.00			c0.03				0.43		0.04		
v/c Ratio		0.00			0.34				0.60		0.05	0.68	
Uniform Delay, d1		37.6			38.9				6.4		3.8	7.1	
Progression Factor		1.00			1.00				1.00		1.00	1.00	
Incremental Delay, d2		0.0			1.4				0.7		0.1	1.4	
Delay (s)		37.6			40.4				7.1		3.8	8.5	
Level of Service		D			D				A		A	A	
Approach Delay (s)		37.6			40.4				7.1			8.4	
Approach LOS		D			D				A			A	
Intersection Summary													
HCM 2000 Control Delay			8.8									HCM 2000 Level of Service	A
HCM 2000 Volume to Capacity ratio			0.61										
Actuated Cycle Length (s)			93.2									Sum of lost time (s)	13.5
Intersection Capacity Utilization			55.8%									ICU Level of Service	B
Analysis Period (min)			15										
c Critical Lane Group													

7: Highway 1 & California Avenue & Wienke Way



Movement	SBR	SEL
Lane Configurations		
Traffic Volume (vph)	10	0
Future Volume (vph)	10	0
Ideal Flow (vphpl)	1900	1900
Total Lost time (s)		
Lane Util. Factor		
Frbp, ped/bikes		
Flpb, ped/bikes		
Frt		
Flt Protected		
Satd. Flow (prot)		
Flt Permitted		
Satd. Flow (perm)		
Peak-hour factor, PHF	0.91	0.92
Adj. Flow (vph)	11	0
RTOR Reduction (vph)	0	0
Lane Group Flow (vph)	0	0
Confl. Peds. (#/hr)	1	
Turn Type		Prot
Protected Phases		9
Permitted Phases		
Actuated Green, G (s)		
Effective Green, g (s)		
Actuated g/C Ratio		
Clearance Time (s)		
Vehicle Extension (s)		
Lane Grp Cap (vph)		
v/s Ratio Prot		
v/s Ratio Perm		
v/c Ratio		
Uniform Delay, d1		
Progression Factor		
Incremental Delay, d2		
Delay (s)		
Level of Service		
Approach Delay (s)		0.0
Approach LOS		A
Intersection Summary		

HCM Signalized Intersection Capacity Analysis Existing plus Project Saturday, Mitigated

7: Highway 1 & California Avenue & Wienke Way

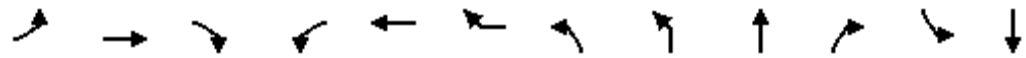

Movement	EBL	EBT	EBR	WBL	WBT	WBR	NBL2	NBL	NBT	NBR	SBL	SBT	
Lane Configurations		↕			↕		↕		↕		↕	↕	
Traffic Volume (vph)	6	3	21	23	3	23	0	28	705	36	7	938	
Future Volume (vph)	6	3	21	23	3	23	0	28	705	36	7	938	
Ideal Flow (vphpl)	1900	1900	1900	1900	1900	1900	1900	1900	1900	1900	1900	1900	
Total Lost time (s)		4.5			4.5				4.5		4.5	4.5	
Lane Util. Factor		1.00			1.00				1.00		1.00	1.00	
Frbp, ped/bikes		1.00			1.00				1.00		1.00	1.00	
Flpb, ped/bikes		1.00			1.00				1.00		1.00	1.00	
Frt		0.90			0.94				0.99		1.00	1.00	
Flt Protected		0.99			0.98				1.00		0.95	1.00	
Satd. Flow (prot)		1667			1703				1846		1770	1861	
Flt Permitted		0.94			0.84				0.94		0.29	1.00	
Satd. Flow (perm)		1588			1468				1743		544	1861	
Peak-hour factor, PHF	0.95	0.95	0.95	0.95	0.95	0.92	0.95	0.92	0.95	0.95	0.95	0.95	
Adj. Flow (vph)	6	3	22	24	3	25	0	30	742	38	7	987	
RTOR Reduction (vph)	0	20	0	0	0	0	0	0	1	0	0	0	
Lane Group Flow (vph)	0	11	0	0	52	0	0	0	809	0	7	994	
Confl. Peds. (#/hr)	1												
Turn Type	Perm	NA		Perm	NA		Perm	Perm	NA		Perm	NA	
Protected Phases		8			4				6			2	
Permitted Phases	8			4			6	6			2		
Actuated Green, G (s)		10.4			10.4				96.5		96.5	96.5	
Effective Green, g (s)		10.4			10.4				96.5		96.5	96.5	
Actuated g/C Ratio		0.08			0.08				0.78		0.78	0.78	
Clearance Time (s)		4.5			4.5				4.5		4.5	4.5	
Vehicle Extension (s)		3.0			3.0				3.0		3.0	3.0	
Lane Grp Cap (vph)		132			122				1354		422	1445	
v/s Ratio Prot												c0.53	
v/s Ratio Perm		0.01			c0.04				0.46		0.01		
v/c Ratio		0.08			0.43				0.60		0.02	0.69	
Uniform Delay, d1		52.5			54.1				5.8		3.1	6.6	
Progression Factor		1.00			1.00				1.00		1.00	1.00	
Incremental Delay, d2		0.3			2.4				0.7		0.0	1.4	
Delay (s)		52.8			56.5				6.5		3.1	8.0	
Level of Service		D			E				A		A	A	
Approach Delay (s)		52.8			56.5				6.5			8.0	
Approach LOS		D			E				A			A	
Intersection Summary													
HCM 2000 Control Delay			9.4									HCM 2000 Level of Service	A
HCM 2000 Volume to Capacity ratio			0.64										
Actuated Cycle Length (s)			124.2									Sum of lost time (s)	13.5
Intersection Capacity Utilization			76.0%									ICU Level of Service	D
Analysis Period (min)			15										
c Critical Lane Group													

HCM Signalized Intersection Capacity Analysis Existing plus Project Saturday, Mitigated
 7: Highway 1 & California Avenue & Wienke Way



Movement	SBR	SEL
Lane Configurations		
Traffic Volume (vph)	7	0
Future Volume (vph)	7	0
Ideal Flow (vphpl)	1900	1900
Total Lost time (s)		
Lane Util. Factor		
Frbp, ped/bikes		
Flpb, ped/bikes		
Frt		
Flt Protected		
Satd. Flow (prot)		
Flt Permitted		
Satd. Flow (perm)		
Peak-hour factor, PHF	0.95	0.92
Adj. Flow (vph)	7	0
RTOR Reduction (vph)	0	0
Lane Group Flow (vph)	0	0
Confl. Peds. (#/hr)		
Turn Type		Prot
Protected Phases		9
Permitted Phases		
Actuated Green, G (s)		
Effective Green, g (s)		
Actuated g/C Ratio		
Clearance Time (s)		
Vehicle Extension (s)		
Lane Grp Cap (vph)		
v/s Ratio Prot		
v/s Ratio Perm		
v/c Ratio		
Uniform Delay, d1		
Progression Factor		
Incremental Delay, d2		
Delay (s)		
Level of Service		
Approach Delay (s)		0.0
Approach LOS		A
Intersection Summary		

Appendix 11 Roundabout Analysis at State
Route 1/ California Avenue /
Wienke Way

Cumulative AM Scenario



Vistro File: \...\Roundabout_Analysis.vistro
Report File: C:\...\VistroResults_CumAM1.pdf

Scenario 1 CumAM
11/20/2018

Intersection Analysis Summary

ID	Intersection Name	Control Type	Method	Worst Mvmt	V/C	Delay (s/veh)	LOS
1	Hwy 1 and California Ave	Roundabout	HCM 6th Edition	SB Thru		14.7	B

V/C, Delay, LOS: For two-way stop, these values are taken from the movement with the worst (highest) delay value. For all other control types, they are taken for the whole intersection.

**Intersection Level Of Service Report
Intersection 1: Hwy 1 and California Ave**

Control Type:	Roundabout	Delay (sec / veh):	14.7
Analysis Method:	HCM 6th Edition	Level Of Service:	B
Analysis Period:	15 minutes		

Intersection Setup

Name	Hwy 1				California Ave				California Ave			
Approach	Southbound				Northeastbound				Southwestbound			
Lane Configuration	✘				✚				✚			
Turning Movement	Left	Thru	Right	Right2	Left2	Left	Thru	Right	Left	Thru	Right	Right2
Lane Width [ft]	12.00	12.00	12.00	12.00	12.00	12.00	12.00	12.00	12.00	12.00	12.00	12.00
No. of Lanes in Pocket	0	0	0	0	0	0	0	0	0	0	0	0
Pocket Length [ft]	100.00	100.00	100.00	100.00	100.00	100.00	100.00	100.00	100.00	100.00	100.00	100.00
Speed [mph]	30.00				30.00				30.00			
Grade [%]	0.00				0.00				0.00			
Crosswalk	Yes				Yes				Yes			

Volumes

Name	Hwy 1				California Ave				California Ave			
Base Volume Input [veh/h]	7	943	7	0	0	12	0	13	56	0	0	18
Base Volume Adjustment Factor	1.0000	1.0000	1.0000	1.0000	1.0000	1.0000	1.0000	1.0000	1.0000	1.0000	1.0000	1.0000
Heavy Vehicles Percentage [%]	2.00	2.00	2.00	2.00	2.00	2.00	2.00	2.00	2.00	2.00	2.00	2.00
Growth Rate	1.00	1.00	1.00	1.00	1.00	1.00	1.00	1.00	1.00	1.00	1.00	1.00
In-Process Volume [veh/h]	0	0	0	0	0	0	0	0	0	0	0	0
Site-Generated Trips [veh/h]	0	0	0	0	0	0	0	0	0	0	0	0
Diverted Trips [veh/h]	0	0	0	0	0	0	0	0	0	0	0	0
Pass-by Trips [veh/h]	0	0	0	0	0	0	0	0	0	0	0	0
Existing Site Adjustment Volume [veh/h]	0	0	0	0	0	0	0	0	0	0	0	0
Other Volume [veh/h]	0	0	0	0	0	0	0	0	0	0	0	0
Total Hourly Volume [veh/h]	7	943	7	0	0	12	0	13	56	0	0	18
Peak Hour Factor	0.9300	0.9300	0.9300	0.9300	0.9300	0.9300	0.9300	0.9300	0.9300	0.9300	0.9300	0.9300
Other Adjustment Factor	1.0000	1.0000	1.0000	1.0000	1.0000	1.0000	1.0000	1.0000	1.0000	1.0000	1.0000	1.0000
Total 15-Minute Volume [veh/h]	2	253	2	0	0	3	0	3	15	0	0	5
Total Analysis Volume [veh/h]	8	1014	8	0	0	13	0	14	60	0	0	19
Pedestrian Volume [ped/h]	0				0				0			

Intersection Settings

Number of Conflicting Circulating Lanes	1				1				1			
Circulating Flow Rate [veh/h]	77				1116				858			
Exiting Flow Rate [veh/h]	862				13				36			
Demand Flow Rate [veh/h]	7	943	7	0	0	12	0	13	56	0	0	18
Adjusted Demand Flow Rate [veh/h]	8	1014	8	0	0	13	0	14	60	0	0	19



Lanes

Overwrite Calculated Critical Headway	No				No				No			
User-Defined Critical Headway [s]	4.00				4.00				4.00			
Overwrite Calculated Follow-Up Time	No				No				No			
User-Defined Follow-Up Time [s]	3.00				3.00				3.00			
A (intercept)	1380.00				1380.00				1380.00			
B (coefficient)	0.00102				0.00102				0.00102			
HV Adjustment Factor	0.98				0.98				0.98			
Entry Flow Rate [veh/h]	1051				28				81			
Capacity of Entry and Bypass Lanes [veh/h]	1277				443				576			
Pedestrian Impedance	1.00				1.00				1.00			
Capacity per Entry Lane [veh/h]	1252				434				565			
X, volume / capacity	0.82				0.06				0.14			

Movement, Approach, & Intersection Results

Lane LOS	C				A				A			
95th-Percentile Queue Length [veh]	10.20				0.20				0.48			
95th-Percentile Queue Length [ft]	254.97				4.96				12.12			
Approach Delay [s/veh]	18.67				9.17				8.12			
Approach LOS	C				A				A			
Intersection Delay [s/veh]					14.71							
Intersection LOS					B							

Intersection Setup

Name	Hwy 1				Wienke Way			
Approach	Northwestbound				Southeastbound			
Lane Configuration								
Turning Movement	Left2	Left	Thru	Right	Left2	Left	Thru	Right
Lane Width [ft]	12.00	12.00	12.00	12.00	12.00	12.00	12.00	12.00
No. of Lanes in Pocket	0	0	0	0	0	0	0	0
Pocket Length [ft]	100.00	100.00	100.00	100.00	100.00	100.00	100.00	100.00
Speed [mph]	30.00				30.00			
Grade [%]	0.00				0.00			
Crosswalk	Yes				Yes			

Volumes

Name	Hwy 1				Wienke Way			
Base Volume Input [veh/h]	5	9	752	25	4	0	7	0
Base Volume Adjustment Factor	1.0000	1.0000	1.0000	1.0000	1.0000	1.0000	1.0000	1.0000
Heavy Vehicles Percentage [%]	2.00	2.00	2.00	2.00	2.00	2.00	2.00	2.00
Growth Rate	1.00	1.00	1.00	1.00	1.00	1.00	1.00	1.00
In-Process Volume [veh/h]	0	0	0	0	0	0	0	0
Site-Generated Trips [veh/h]	0	0	0	0	0	0	0	0
Diverted Trips [veh/h]	0	0	0	0	0	0	0	0
Pass-by Trips [veh/h]	0	0	0	0	0	0	0	0
Existing Site Adjustment Volume [veh/h]	0	0	0	0	0	0	0	0
Other Volume [veh/h]	0	0	0	0	0	0	0	0
Total Hourly Volume [veh/h]	5	9	752	25	4	0	7	0
Peak Hour Factor	0.9300	0.9300	0.9300	0.9300	0.9300	0.9300	0.9300	0.9300
Other Adjustment Factor	1.0000	1.0000	1.0000	1.0000	1.0000	1.0000	1.0000	1.0000
Total 15-Minute Volume [veh/h]	1	2	202	7	1	0	2	0
Total Analysis Volume [veh/h]	5	10	809	27	4	0	8	0
Pedestrian Volume [ped/h]	1				0			

Intersection Settings

Number of Conflicting Circulating Lanes	1				1			
Circulating Flow Rate [veh/h]	26				1117			
Exiting Flow Rate [veh/h]	1118				10			
Demand Flow Rate [veh/h]	5	9	752	25	4	0	7	0
Adjusted Demand Flow Rate [veh/h]	5	10	809	27	4	0	8	0

Lanes

Overwrite Calculated Critical Headway	No	No
User-Defined Critical Headway [s]	4.00	4.00
Overwrite Calculated Follow-Up Time	No	No
User-Defined Follow-Up Time [s]	3.00	3.00
A (intercept)	1380.00	1380.00
B (coefficient)	0.00102	0.00102
HV Adjustment Factor	0.98	0.98
Entry Flow Rate [veh/h]	869	13
Capacity of Entry and Bypass Lanes [veh/h]	1345	442
Pedestrian Impedance	1.00	1.00
Capacity per Entry Lane [veh/h]	1319	434
X, volume / capacity	0.65	0.03

Movement, Approach, & Intersection Results

Lane LOS	B	A
95th-Percentile Queue Length [veh]	5.03	0.09
95th-Percentile Queue Length [ft]	125.82	2.13
Approach Delay [s/veh]	10.79	8.69
Approach LOS	B	A
Intersection Delay [s/veh]	14.71	
Intersection LOS	B	

Cumulative PM Scenario



Vistro File: \\...\Roundabout_Analysis.vistro
Report File: C:\...\VistroResults_CumPM.pdf

Scenario 2 CumPM
11/20/2018

Intersection Analysis Summary

ID	Intersection Name	Control Type	Method	Worst Mvmt	V/C	Delay (s/veh)	LOS
1	Hwy 1 and California Ave	Roundabout	HCM 6th Edition	NWB Thru		22.6	C

V/C, Delay, LOS: For two-way stop, these values are taken from the movement with the worst (highest) delay value. For all other control types, they are taken for the whole intersection.

Intersection Level Of Service Report
Intersection 1: Hwy 1 and California Ave

Control Type:	Roundabout	Delay (sec / veh):	22.6
Analysis Method:	HCM 6th Edition	Level Of Service:	C
Analysis Period:	15 minutes		

Intersection Setup

Name	Hwy 1				California Ave				California Ave			
Approach	Southbound				Northeastbound				Southwestbound			
Lane Configuration												
Turning Movement	Left	Thru	Right	Right2	Left2	Left	Thru	Right	Left	Thru	Right	Right2
Lane Width [ft]	12.00	12.00	12.00	12.00	12.00	12.00	12.00	12.00	12.00	12.00	12.00	12.00
No. of Lanes in Pocket	0	0	0	0	0	0	0	0	0	0	0	0
Pocket Length [ft]	100.00	100.00	100.00	100.00	100.00	100.00	100.00	100.00	100.00	100.00	100.00	100.00
Speed [mph]	30.00				30.00				30.00			
Grade [%]	0.00				0.00				0.00			
Crosswalk	Yes				Yes				Yes			

Volumes

Name	Hwy 1				California Ave				California Ave			
Base Volume Input [veh/h]	20	972	12	2	0	4	0	4	37	0	0	16
Base Volume Adjustment Factor	1.0000	1.0000	1.0000	1.0000	1.0000	1.0000	1.0000	1.0000	1.0000	1.0000	1.0000	1.0000
Heavy Vehicles Percentage [%]	2.00	2.00	2.00	2.00	2.00	2.00	2.00	2.00	2.00	2.00	2.00	2.00
Growth Rate	1.00	1.00	1.00	1.00	1.00	1.00	1.00	1.00	1.00	1.00	1.00	1.00
In-Process Volume [veh/h]	0	0	0	0	0	0	0	0	0	0	0	0
Site-Generated Trips [veh/h]	0	0	0	0	0	0	0	0	0	0	0	0
Diverted Trips [veh/h]	0	0	0	0	0	0	0	0	0	0	0	0
Pass-by Trips [veh/h]	0	0	0	0	0	0	0	0	0	0	0	0
Existing Site Adjustment Volume [veh/h]	0	0	0	0	0	0	0	0	0	0	0	0
Other Volume [veh/h]	0	0	0	0	0	0	0	0	0	0	0	0
Total Hourly Volume [veh/h]	20	972	12	2	0	4	0	4	37	0	0	16
Peak Hour Factor	0.9300	0.9300	0.9300	0.9300	0.9300	0.9300	0.9300	0.9300	0.9300	0.9300	0.9300	0.9300
Other Adjustment Factor	1.0000	1.0000	1.0000	1.0000	1.0000	1.0000	1.0000	1.0000	1.0000	1.0000	1.0000	1.0000
Total 15-Minute Volume [veh/h]	5	261	3	1	0	1	0	1	10	0	0	4
Total Analysis Volume [veh/h]	22	1045	13	2	0	4	0	4	40	0	0	17
Pedestrian Volume [ped/h]	0				1				0			

Intersection Settings

Number of Conflicting Circulating Lanes	1				1				1			
Circulating Flow Rate [veh/h]	58				1134				1163			
Exiting Flow Rate [veh/h]	1163				19				77			
Demand Flow Rate [veh/h]	20	972	12	2	0	4	0	4	37	0	0	16
Adjusted Demand Flow Rate [veh/h]	22	1045	13	2	0	4	0	4	40	0	0	17



Lanes

Overwrite Calculated Critical Headway	No				No				No			
User-Defined Critical Headway [s]	4.00				4.00				4.00			
Overwrite Calculated Follow-Up Time	No				No				No			
User-Defined Follow-Up Time [s]	3.00				3.00				3.00			
A (intercept)	1380.00				1380.00				1380.00			
B (coefficient)	0.00102				0.00102				0.00102			
HV Adjustment Factor	0.98				0.98				0.98			
Entry Flow Rate [veh/h]	1104				9				59			
Capacity of Entry and Bypass Lanes [veh/h]	1301				434				422			
Pedestrian Impedance	1.00				1.00				1.00			
Capacity per Entry Lane [veh/h]	1276				426				414			
X, volume / capacity	0.85				0.02				0.14			

Movement, Approach, & Intersection Results

Lane LOS	C				A				B			
95th-Percentile Queue Length [veh]	11.42				0.06				0.47			
95th-Percentile Queue Length [ft]	285.38				1.44				11.87			
Approach Delay [s/veh]	20.32				8.72				10.79			
Approach LOS	C				A				B			
Intersection Delay [s/veh]					22.57							
Intersection LOS					C							

Intersection Setup

Name	Hwy 1				Wienke Way			
Approach	Northwestbound				Southeastbound			
Lane Configuration								
Turning Movement	Left2	Left	Thru	Right	Left2	Left	Thru	Right
Lane Width [ft]	12.00	12.00	12.00	12.00	12.00	12.00	12.00	12.00
No. of Lanes in Pocket	0	0	0	0	0	0	0	0
Pocket Length [ft]	100.00	100.00	100.00	100.00	100.00	100.00	100.00	100.00
Speed [mph]	30.00				30.00			
Grade [%]	0.00				0.00			
Crosswalk	Yes				Yes			

Volumes

Name	Hwy 1				Wienke Way			
Base Volume Input [veh/h]	6	10	1039	49	2	0	3	0
Base Volume Adjustment Factor	1.0000	1.0000	1.0000	1.0000	1.0000	1.0000	1.0000	1.0000
Heavy Vehicles Percentage [%]	2.00	2.00	2.00	2.00	2.00	2.00	2.00	2.00
Growth Rate	1.00	1.00	1.00	1.00	1.00	1.00	1.00	1.00
In-Process Volume [veh/h]	0	0	0	0	0	0	0	0
Site-Generated Trips [veh/h]	0	0	0	0	0	0	0	0
Diverted Trips [veh/h]	0	0	0	0	0	0	0	0
Pass-by Trips [veh/h]	0	0	0	0	0	0	0	0
Existing Site Adjustment Volume [veh/h]	0	0	0	0	0	0	0	0
Other Volume [veh/h]	0	0	0	0	0	0	0	0
Total Hourly Volume [veh/h]	6	10	1039	49	2	0	3	0
Peak Hour Factor	0.9300	0.9300	0.9300	0.9300	0.9300	0.9300	0.9300	0.9300
Other Adjustment Factor	1.0000	1.0000	1.0000	1.0000	1.0000	1.0000	1.0000	1.0000
Total 15-Minute Volume [veh/h]	2	3	279	13	1	0	1	0
Total Analysis Volume [veh/h]	6	11	1117	53	2	0	3	0
Pedestrian Volume [ped/h]	1				1			

Intersection Settings

Number of Conflicting Circulating Lanes	1				1			
Circulating Flow Rate [veh/h]	29				1149			
Exiting Flow Rate [veh/h]	1114				13			
Demand Flow Rate [veh/h]	6	10	1039	49	2	0	3	0
Adjusted Demand Flow Rate [veh/h]	6	11	1117	53	2	0	3	0

Lanes

Overwrite Calculated Critical Headway	No				No			
User-Defined Critical Headway [s]	4.00				4.00			
Overwrite Calculated Follow-Up Time	No				No			
User-Defined Follow-Up Time [s]	3.00				3.00			
A (intercept)	1380.00				1380.00			
B (coefficient)	0.00102				0.00102			
HV Adjustment Factor	0.98				0.98			
Entry Flow Rate [veh/h]	1211				6			
Capacity of Entry and Bypass Lanes [veh/h]	1341				428			
Pedestrian Impedance	1.00				1.00			
Capacity per Entry Lane [veh/h]	1314				420			
X, volume / capacity	0.90				0.01			

Movement, Approach, & Intersection Results

Lane LOS	D				A			
95th-Percentile Queue Length [veh]	14.61				0.04			
95th-Percentile Queue Length [ft]	365.19				0.90			
Approach Delay [s/veh]	25.35				8.75			
Approach LOS	D				A			
Intersection Delay [s/veh]					22.57			
Intersection LOS					C			

Cumulative Saturday Midday Scenario



Vistro File: \\...\Roundabout_Analysis.vistro
Report File: C:\...\VistroResults_CumMid.pdf

Scenario 3 CumMid
11/20/2018

Intersection Analysis Summary

ID	Intersection Name	Control Type	Method	Worst Mvmt	V/C	Delay (s/veh)	LOS
1	Hwy 1 and California Ave	Roundabout	HCM 6th Edition	SB Thru		14.4	B

V/C, Delay, LOS: For two-way stop, these values are taken from the movement with the worst (highest) delay value. For all other control types, they are taken for the whole intersection.

**Intersection Level Of Service Report
Intersection 1: Hwy 1 and California Ave**

Control Type:	Roundabout	Delay (sec / veh):	14.4
Analysis Method:	HCM 6th Edition	Level Of Service:	B
Analysis Period:	15 minutes		

Intersection Setup

Name	Hwy 1				California Ave				California Ave			
Approach	Southbound				Northeastbound				Southwestbound			
Lane Configuration	✘				✚				✚			
Turning Movement	Left	Thru	Right	Right2	Left2	Left	Thru	Right	Left	Thru	Right	Right2
Lane Width [ft]	12.00	12.00	12.00	12.00	12.00	12.00	12.00	12.00	12.00	12.00	12.00	12.00
No. of Lanes in Pocket	0	0	0	0	0	0	0	0	0	0	0	0
Pocket Length [ft]	100.00	100.00	100.00	100.00	100.00	100.00	100.00	100.00	100.00	100.00	100.00	100.00
Speed [mph]	30.00				30.00				30.00			
Grade [%]	0.00				0.00				0.00			
Crosswalk	Yes				Yes				Yes			

Volumes

Name	Hwy 1				California Ave				California Ave			
Base Volume Input [veh/h]	9	928	9	6	0	7	4	25	27	4	0	27
Base Volume Adjustment Factor	1.0000	1.0000	1.0000	1.0000	1.0000	1.0000	1.0000	1.0000	1.0000	1.0000	1.0000	1.0000
Heavy Vehicles Percentage [%]	2.00	2.00	2.00	2.00	2.00	2.00	2.00	2.00	2.00	2.00	2.00	2.00
Growth Rate	1.00	1.00	1.00	1.00	1.00	1.00	1.00	1.00	1.00	1.00	1.00	1.00
In-Process Volume [veh/h]	0	0	0	0	0	0	0	0	0	0	0	0
Site-Generated Trips [veh/h]	0	0	0	0	0	0	0	0	0	0	0	0
Diverted Trips [veh/h]	0	0	0	0	0	0	0	0	0	0	0	0
Pass-by Trips [veh/h]	0	0	0	0	0	0	0	0	0	0	0	0
Existing Site Adjustment Volume [veh/h]	0	0	0	0	0	0	0	0	0	0	0	0
Other Volume [veh/h]	0	0	0	0	0	0	0	0	0	0	0	0
Total Hourly Volume [veh/h]	9	928	9	6	0	7	4	25	27	4	0	27
Peak Hour Factor	0.9300	0.9300	0.9300	0.9300	0.9300	0.9300	0.9300	0.9300	0.9300	0.9300	0.9300	0.9300
Other Adjustment Factor	1.0000	1.0000	1.0000	1.0000	1.0000	1.0000	1.0000	1.0000	1.0000	1.0000	1.0000	1.0000
Total 15-Minute Volume [veh/h]	2	249	2	2	0	2	1	7	7	1	0	7
Total Analysis Volume [veh/h]	10	998	10	6	0	8	4	27	29	4	0	29
Pedestrian Volume [ped/h]	0				0				0			

Intersection Settings

Number of Conflicting Circulating Lanes	1				1				1			
Circulating Flow Rate [veh/h]	74				1073				817			
Exiting Flow Rate [veh/h]	806				50				60			
Demand Flow Rate [veh/h]	9	928	9	6	0	7	4	25	27	4	0	27
Adjusted Demand Flow Rate [veh/h]	10	998	10	6	0	8	4	27	29	4	0	29



Lanes

Overwrite Calculated Critical Headway	No				No				No			
User-Defined Critical Headway [s]	4.00				4.00				4.00			
Overwrite Calculated Follow-Up Time	No				No				No			
User-Defined Follow-Up Time [s]	3.00				3.00				3.00			
A (intercept)	1380.00				1380.00				1380.00			
B (coefficient)	0.00102				0.00102				0.00102			
HV Adjustment Factor	0.98				0.98				0.98			
Entry Flow Rate [veh/h]	1045				40				64			
Capacity of Entry and Bypass Lanes [veh/h]	1280				462				600			
Pedestrian Impedance	1.00				1.00				1.00			
Capacity per Entry Lane [veh/h]	1254				453				588			
X, volume / capacity	0.82				0.09				0.11			

Movement, Approach, & Intersection Results

Lane LOS	C				A				A			
95th-Percentile Queue Length [veh]	9.93				0.28				0.35			
95th-Percentile Queue Length [ft]	248.21				7.03				8.79			
Approach Delay [s/veh]	18.20				9.13				7.37			
Approach LOS	C				A				A			
Intersection Delay [s/veh]					14.35							
Intersection LOS					B							

Intersection Setup

Name	Hwy 1				Wienke Way			
Approach	Northwestbound				Southeastbound			
Lane Configuration								
Turning Movement	Left2	Left	Thru	Right	Left2	Left	Thru	Right
Lane Width [ft]	12.00	12.00	12.00	12.00	12.00	12.00	12.00	12.00
No. of Lanes in Pocket	0	0	0	0	0	0	0	0
Pocket Length [ft]	100.00	100.00	100.00	100.00	100.00	100.00	100.00	100.00
Speed [mph]	30.00				30.00			
Grade [%]	0.00				0.00			
Crosswalk	Yes				Yes			

Volumes

Name	Hwy 1				Wienke Way			
Base Volume Input [veh/h]	33	5	697	42	4	0	10	0
Base Volume Adjustment Factor	1.0000	1.0000	1.0000	1.0000	1.0000	1.0000	1.0000	1.0000
Heavy Vehicles Percentage [%]	2.00	2.00	2.00	2.00	2.00	2.00	2.00	2.00
Growth Rate	1.00	1.00	1.00	1.00	1.00	1.00	1.00	1.00
In-Process Volume [veh/h]	0	0	0	0	0	0	0	0
Site-Generated Trips [veh/h]	0	0	0	0	0	0	0	0
Diverted Trips [veh/h]	0	0	0	0	0	0	0	0
Pass-by Trips [veh/h]	0	0	0	0	0	0	0	0
Existing Site Adjustment Volume [veh/h]	0	0	0	0	0	0	0	0
Other Volume [veh/h]	0	0	0	0	0	0	0	0
Total Hourly Volume [veh/h]	33	5	697	42	4	0	10	0
Peak Hour Factor	0.9300	0.9300	0.9300	0.9300	0.9300	0.9300	0.9300	0.9300
Other Adjustment Factor	1.0000	1.0000	1.0000	1.0000	1.0000	1.0000	1.0000	1.0000
Total 15-Minute Volume [veh/h]	9	1	187	11	1	0	3	0
Total Analysis Volume [veh/h]	35	5	749	45	4	0	11	0
Pedestrian Volume [ped/h]	0				0			

Intersection Settings

Number of Conflicting Circulating Lanes	1				1			
Circulating Flow Rate [veh/h]	27				1108			
Exiting Flow Rate [veh/h]	1086				11			
Demand Flow Rate [veh/h]	33	5	697	42	4	0	10	0
Adjusted Demand Flow Rate [veh/h]	35	5	749	45	4	0	11	0

Lanes

Overwrite Calculated Critical Headway	No				No			
User-Defined Critical Headway [s]	4.00				4.00			
Overwrite Calculated Follow-Up Time	No				No			
User-Defined Follow-Up Time [s]	3.00				3.00			
A (intercept)	1380.00				1380.00			
B (coefficient)	0.00102				0.00102			
HV Adjustment Factor	0.98				0.98			
Entry Flow Rate [veh/h]	851				16			
Capacity of Entry and Bypass Lanes [veh/h]	1344				446			
Pedestrian Impedance	1.00				1.00			
Capacity per Entry Lane [veh/h]	1317				438			
X, volume / capacity	0.63				0.03			

Movement, Approach, & Intersection Results

Lane LOS	B				A			
95th-Percentile Queue Length [veh]	4.80				0.11			
95th-Percentile Queue Length [ft]	120.00				2.66			
Approach Delay [s/veh]	10.49				8.70			
Approach LOS	B				A			
Intersection Delay [s/veh]					14.35			
Intersection LOS					B			

Cumulative with Project AM Scenario



Vistro File: \\...\Roundabout_Analysis.vistro

Scenario 4 CumPrAM

Report File: C:\...\VistroResults_CumPrAM.pdf

11/20/2018

Intersection Analysis Summary

ID	Intersection Name	Control Type	Method	Worst Mvmt	V/C	Delay (s/veh)	LOS
1	Hwy 1 and California Ave	Roundabout	HCM 6th Edition	SB Thru		15.2	C

V/C, Delay, LOS: For two-way stop, these values are taken from the movement with the worst (highest) delay value. For all other control types, they are taken for the whole intersection.

Intersection Level Of Service Report
Intersection 1: Hwy 1 and California Ave

Control Type:	Roundabout	Delay (sec / veh):	15.2
Analysis Method:	HCM 6th Edition	Level Of Service:	C
Analysis Period:	15 minutes		

Intersection Setup

Name	Hwy 1				California Ave				California Ave			
Approach	Southbound				Northeastbound				Southwestbound			
Lane Configuration	✘				✚				✚			
Turning Movement	Left	Thru	Right	Right2	Left2	Left	Thru	Right	Left	Thru	Right	Right2
Lane Width [ft]	12.00	12.00	12.00	12.00	12.00	12.00	12.00	12.00	12.00	12.00	12.00	12.00
No. of Lanes in Pocket	0	0	0	0	0	0	0	0	0	0	0	0
Pocket Length [ft]	100.00	100.00	100.00	100.00	100.00	100.00	100.00	100.00	100.00	100.00	100.00	100.00
Speed [mph]	30.00				30.00				30.00			
Grade [%]	0.00				0.00				0.00			
Crosswalk	Yes				Yes				Yes			

Volumes

Name	Hwy 1				California Ave				California Ave			
Base Volume Input [veh/h]	7	957	7	0	0	12	0	13	56	0	0	18
Base Volume Adjustment Factor	1.0000	1.0000	1.0000	1.0000	1.0000	1.0000	1.0000	1.0000	1.0000	1.0000	1.0000	1.0000
Heavy Vehicles Percentage [%]	2.00	2.00	2.00	2.00	2.00	2.00	2.00	2.00	2.00	2.00	2.00	2.00
Growth Rate	1.00	1.00	1.00	1.00	1.00	1.00	1.00	1.00	1.00	1.00	1.00	1.00
In-Process Volume [veh/h]	0	0	0	0	0	0	0	0	0	0	0	0
Site-Generated Trips [veh/h]	0	0	0	0	0	0	0	0	0	0	0	0
Diverted Trips [veh/h]	0	0	0	0	0	0	0	0	0	0	0	0
Pass-by Trips [veh/h]	0	0	0	0	0	0	0	0	0	0	0	0
Existing Site Adjustment Volume [veh/h]	0	0	0	0	0	0	0	0	0	0	0	0
Other Volume [veh/h]	0	0	0	0	0	0	0	0	0	0	0	0
Total Hourly Volume [veh/h]	7	957	7	0	0	12	0	13	56	0	0	18
Peak Hour Factor	0.9300	0.9300	0.9300	0.9300	0.9300	0.9300	0.9300	0.9300	0.9300	0.9300	0.9300	0.9300
Other Adjustment Factor	1.0000	1.0000	1.0000	1.0000	1.0000	1.0000	1.0000	1.0000	1.0000	1.0000	1.0000	1.0000
Total 15-Minute Volume [veh/h]	2	257	2	0	0	3	0	3	15	0	0	5
Total Analysis Volume [veh/h]	8	1029	8	0	0	13	0	14	60	0	0	19
Pedestrian Volume [ped/h]	0				0				0			

Intersection Settings

Number of Conflicting Circulating Lanes	1				1				1			
Circulating Flow Rate [veh/h]	77				1131				862			
Exiting Flow Rate [veh/h]	866				13				36			
Demand Flow Rate [veh/h]	7	957	7	0	0	12	0	13	56	0	0	18
Adjusted Demand Flow Rate [veh/h]	8	1029	8	0	0	13	0	14	60	0	0	19



Lanes

Overwrite Calculated Critical Headway	No				No				No			
User-Defined Critical Headway [s]	4.00				4.00				4.00			
Overwrite Calculated Follow-Up Time	No				No				No			
User-Defined Follow-Up Time [s]	3.00				3.00				3.00			
A (intercept)	1380.00				1380.00				1380.00			
B (coefficient)	0.00102				0.00102				0.00102			
HV Adjustment Factor	0.98				0.98				0.98			
Entry Flow Rate [veh/h]	1066				28				81			
Capacity of Entry and Bypass Lanes [veh/h]	1277				436				573			
Pedestrian Impedance	1.00				1.00				1.00			
Capacity per Entry Lane [veh/h]	1252				427				562			
X, volume / capacity	0.84				0.06				0.14			

Movement, Approach, & Intersection Results

Lane LOS	C				A				A			
95th-Percentile Queue Length [veh]	10.73				0.20				0.49			
95th-Percentile Queue Length [ft]	268.21				5.05				12.18			
Approach Delay [s/veh]	19.52				9.32				8.16			
Approach LOS	C				A				A			
Intersection Delay [s/veh]					15.21							
Intersection LOS					C							

Intersection Setup

Name	Hwy 1				Wienke Way			
Approach	Northwestbound				Southeastbound			
Lane Configuration								
Turning Movement	Left2	Left	Thru	Right	Left2	Left	Thru	Right
Lane Width [ft]	12.00	12.00	12.00	12.00	12.00	12.00	12.00	12.00
No. of Lanes in Pocket	0	0	0	0	0	0	0	0
Pocket Length [ft]	100.00	100.00	100.00	100.00	100.00	100.00	100.00	100.00
Speed [mph]	30.00				30.00			
Grade [%]	0.00				0.00			
Crosswalk	Yes				Yes			

Volumes

Name	Hwy 1				Wienke Way			
Base Volume Input [veh/h]	5	9	756	25	4	0	7	0
Base Volume Adjustment Factor	1.0000	1.0000	1.0000	1.0000	1.0000	1.0000	1.0000	1.0000
Heavy Vehicles Percentage [%]	2.00	2.00	2.00	2.00	2.00	2.00	2.00	2.00
Growth Rate	1.00	1.00	1.00	1.00	1.00	1.00	1.00	1.00
In-Process Volume [veh/h]	0	0	0	0	0	0	0	0
Site-Generated Trips [veh/h]	0	0	0	0	0	0	0	0
Diverted Trips [veh/h]	0	0	0	0	0	0	0	0
Pass-by Trips [veh/h]	0	0	0	0	0	0	0	0
Existing Site Adjustment Volume [veh/h]	0	0	0	0	0	0	0	0
Other Volume [veh/h]	0	0	0	0	0	0	0	0
Total Hourly Volume [veh/h]	5	9	756	25	4	0	7	0
Peak Hour Factor	0.9300	0.9300	0.9300	0.9300	0.9300	0.9300	0.9300	0.9300
Other Adjustment Factor	1.0000	1.0000	1.0000	1.0000	1.0000	1.0000	1.0000	1.0000
Total 15-Minute Volume [veh/h]	1	2	203	7	1	0	2	0
Total Analysis Volume [veh/h]	5	10	813	27	4	0	8	0
Pedestrian Volume [ped/h]	1				0			

Intersection Settings

Number of Conflicting Circulating Lanes	1				1			
Circulating Flow Rate [veh/h]	26				1132			
Exiting Flow Rate [veh/h]	1133				10			
Demand Flow Rate [veh/h]	5	9	756	25	4	0	7	0
Adjusted Demand Flow Rate [veh/h]	5	10	813	27	4	0	8	0

Lanes

Overwrite Calculated Critical Headway	No				No			
User-Defined Critical Headway [s]	4.00				4.00			
Overwrite Calculated Follow-Up Time	No				No			
User-Defined Follow-Up Time [s]	3.00				3.00			
A (intercept)	1380.00				1380.00			
B (coefficient)	0.00102				0.00102			
HV Adjustment Factor	0.98				0.98			
Entry Flow Rate [veh/h]	873				13			
Capacity of Entry and Bypass Lanes [veh/h]	1345				435			
Pedestrian Impedance	1.00				1.00			
Capacity per Entry Lane [veh/h]	1319				427			
X, volume / capacity	0.65				0.03			

Movement, Approach, & Intersection Results

Lane LOS	B				A			
95th-Percentile Queue Length [veh]	5.09				0.09			
95th-Percentile Queue Length [ft]	127.29				2.17			
Approach Delay [s/veh]	10.87				8.83			
Approach LOS	B				A			
Intersection Delay [s/veh]					15.21			
Intersection LOS					C			

Cumulative with Project PM
Scenario



Vistro File: \...\Roundabout_Analysis.vistro

Scenario 5 CumPrPM

Report File: C:\...\VistroResults_CumPrPM.pdf

11/20/2018

Intersection Analysis Summary

ID	Intersection Name	Control Type	Method	Worst Mvmt	V/C	Delay (s/veh)	LOS
1	Hwy 1 and California Ave	Roundabout	HCM 6th Edition	NWB Thru		23.6	C

V/C, Delay, LOS: For two-way stop, these values are taken from the movement with the worst (highest) delay value. For all other control types, they are taken for the whole intersection.

Intersection Level Of Service Report
Intersection 1: Hwy 1 and California Ave

Control Type:	Roundabout	Delay (sec / veh):	23.6
Analysis Method:	HCM 6th Edition	Level Of Service:	C
Analysis Period:	15 minutes		

Intersection Setup

Name	Hwy 1				California Ave				California Ave			
Approach	Southbound				Northeastbound				Southwestbound			
Lane Configuration	✘				✚				✚			
Turning Movement	Left	Thru	Right	Right2	Left2	Left	Thru	Right	Left	Thru	Right	Right2
Lane Width [ft]	12.00	12.00	12.00	12.00	12.00	12.00	12.00	12.00	12.00	12.00	12.00	12.00
No. of Lanes in Pocket	0	0	0	0	0	0	0	0	0	0	0	0
Pocket Length [ft]	100.00	100.00	100.00	100.00	100.00	100.00	100.00	100.00	100.00	100.00	100.00	100.00
Speed [mph]	30.00				30.00				30.00			
Grade [%]	0.00				0.00				0.00			
Crosswalk	Yes				Yes				Yes			

Volumes

Name	Hwy 1				California Ave				California Ave			
Base Volume Input [veh/h]	20	981	12	2	0	4	0	4	37	0	0	16
Base Volume Adjustment Factor	1.0000	1.0000	1.0000	1.0000	1.0000	1.0000	1.0000	1.0000	1.0000	1.0000	1.0000	1.0000
Heavy Vehicles Percentage [%]	2.00	2.00	2.00	2.00	2.00	2.00	2.00	2.00	2.00	2.00	2.00	2.00
Growth Rate	1.00	1.00	1.00	1.00	1.00	1.00	1.00	1.00	1.00	1.00	1.00	1.00
In-Process Volume [veh/h]	0	0	0	0	0	0	0	0	0	0	0	0
Site-Generated Trips [veh/h]	0	0	0	0	0	0	0	0	0	0	0	0
Diverted Trips [veh/h]	0	0	0	0	0	0	0	0	0	0	0	0
Pass-by Trips [veh/h]	0	0	0	0	0	0	0	0	0	0	0	0
Existing Site Adjustment Volume [veh/h]	0	0	0	0	0	0	0	0	0	0	0	0
Other Volume [veh/h]	0	0	0	0	0	0	0	0	0	0	0	0
Total Hourly Volume [veh/h]	20	981	12	2	0	4	0	4	37	0	0	16
Peak Hour Factor	0.9300	0.9300	0.9300	0.9300	0.9300	0.9300	0.9300	0.9300	0.9300	0.9300	0.9300	0.9300
Other Adjustment Factor	1.0000	1.0000	1.0000	1.0000	1.0000	1.0000	1.0000	1.0000	1.0000	1.0000	1.0000	1.0000
Total 15-Minute Volume [veh/h]	5	264	3	1	0	1	0	1	10	0	0	4
Total Analysis Volume [veh/h]	22	1055	13	2	0	4	0	4	40	0	0	17
Pedestrian Volume [ped/h]	0				1				0			

Intersection Settings

Number of Conflicting Circulating Lanes	1				1				1			
Circulating Flow Rate [veh/h]	58				1144				1177			
Exiting Flow Rate [veh/h]	1177				19				77			
Demand Flow Rate [veh/h]	20	981	12	2	0	4	0	4	37	0	0	16
Adjusted Demand Flow Rate [veh/h]	22	1055	13	2	0	4	0	4	40	0	0	17



Lanes

Overwrite Calculated Critical Headway	No				No				No			
User-Defined Critical Headway [s]	4.00				4.00				4.00			
Overwrite Calculated Follow-Up Time	No				No				No			
User-Defined Follow-Up Time [s]	3.00				3.00				3.00			
A (intercept)	1380.00				1380.00				1380.00			
B (coefficient)	0.00102				0.00102				0.00102			
HV Adjustment Factor	0.98				0.98				0.98			
Entry Flow Rate [veh/h]	1114				9				59			
Capacity of Entry and Bypass Lanes [veh/h]	1301				430				416			
Pedestrian Impedance	1.00				1.00				1.00			
Capacity per Entry Lane [veh/h]	1276				422				408			
X, volume / capacity	0.86				0.02				0.14			

Movement, Approach, & Intersection Results

Lane LOS	C				A				B			
95th-Percentile Queue Length [veh]	11.81				0.06				0.48			
95th-Percentile Queue Length [ft]	295.15				1.45				12.07			
Approach Delay [s/veh]	20.97				8.81				10.97			
Approach LOS	C				A				B			
Intersection Delay [s/veh]					23.58							
Intersection LOS					C							

Intersection Setup

Name	Hwy 1				Wienke Way			
Approach	Northwestbound				Southeastbound			
Lane Configuration								
Turning Movement	Left2	Left	Thru	Right	Left2	Left	Thru	Right
Lane Width [ft]	12.00	12.00	12.00	12.00	12.00	12.00	12.00	12.00
No. of Lanes in Pocket	0	0	0	0	0	0	0	0
Pocket Length [ft]	100.00	100.00	100.00	100.00	100.00	100.00	100.00	100.00
Speed [mph]	30.00				30.00			
Grade [%]	0.00				0.00			
Crosswalk	Yes				Yes			

Volumes

Name	Hwy 1				Wienke Way			
Base Volume Input [veh/h]	6	10	1052	49	2	0	3	0
Base Volume Adjustment Factor	1.0000	1.0000	1.0000	1.0000	1.0000	1.0000	1.0000	1.0000
Heavy Vehicles Percentage [%]	2.00	2.00	2.00	2.00	2.00	2.00	2.00	2.00
Growth Rate	1.00	1.00	1.00	1.00	1.00	1.00	1.00	1.00
In-Process Volume [veh/h]	0	0	0	0	0	0	0	0
Site-Generated Trips [veh/h]	0	0	0	0	0	0	0	0
Diverted Trips [veh/h]	0	0	0	0	0	0	0	0
Pass-by Trips [veh/h]	0	0	0	0	0	0	0	0
Existing Site Adjustment Volume [veh/h]	0	0	0	0	0	0	0	0
Other Volume [veh/h]	0	0	0	0	0	0	0	0
Total Hourly Volume [veh/h]	6	10	1052	49	2	0	3	0
Peak Hour Factor	0.9300	0.9300	0.9300	0.9300	0.9300	0.9300	0.9300	0.9300
Other Adjustment Factor	1.0000	1.0000	1.0000	1.0000	1.0000	1.0000	1.0000	1.0000
Total 15-Minute Volume [veh/h]	2	3	283	13	1	0	1	0
Total Analysis Volume [veh/h]	6	11	1131	53	2	0	3	0
Pedestrian Volume [ped/h]	1				1			

Intersection Settings

Number of Conflicting Circulating Lanes	1				1			
Circulating Flow Rate [veh/h]	29				1159			
Exiting Flow Rate [veh/h]	1124				13			
Demand Flow Rate [veh/h]	6	10	1052	49	2	0	3	0
Adjusted Demand Flow Rate [veh/h]	6	11	1131	53	2	0	3	0

Lanes

Overwrite Calculated Critical Headway	No				No			
User-Defined Critical Headway [s]	4.00				4.00			
Overwrite Calculated Follow-Up Time	No				No			
User-Defined Follow-Up Time [s]	3.00				3.00			
A (intercept)	1380.00				1380.00			
B (coefficient)	0.00102				0.00102			
HV Adjustment Factor	0.98				0.98			
Entry Flow Rate [veh/h]	1226				6			
Capacity of Entry and Bypass Lanes [veh/h]	1341				424			
Pedestrian Impedance	1.00				1.00			
Capacity per Entry Lane [veh/h]	1314				415			
X, volume / capacity	0.91				0.01			

Movement, Approach, & Intersection Results

Lane LOS	D				A			
95th-Percentile Queue Length [veh]	15.31				0.04			
95th-Percentile Queue Length [ft]	382.69				0.91			
Approach Delay [s/veh]	26.72				8.84			
Approach LOS	D				A			
Intersection Delay [s/veh]					23.58			
Intersection LOS					C			

Cumulative with Project
Saturday Midday Scenario



Vistro File: \...\Roundabout_Analysis.vistro

Scenario 6 CumPrMid

Report File: C:\...\VistroResults_CumPrMid.pdf

11/20/2018

Intersection Analysis Summary

ID	Intersection Name	Control Type	Method	Worst Mvmt	V/C	Delay (s/veh)	LOS
1	Hwy 1 and California Ave	Roundabout	HCM 6th Edition	SB Thru		14.7	B

V/C, Delay, LOS: For two-way stop, these values are taken from the movement with the worst (highest) delay value. For all other control types, they are taken for the whole intersection.

Intersection Level Of Service Report
Intersection 1: Hwy 1 and California Ave

Control Type:	Roundabout	Delay (sec / veh):	14.7
Analysis Method:	HCM 6th Edition	Level Of Service:	B
Analysis Period:	15 minutes		

Intersection Setup

Name	Hwy 1				California Ave				California Ave			
Approach	Southbound				Northeastbound				Southwestbound			
Lane Configuration	✘				✚				✚			
Turning Movement	Left	Thru	Right	Right2	Left2	Left	Thru	Right	Left	Thru	Right	Right2
Lane Width [ft]	12.00	12.00	12.00	12.00	12.00	12.00	12.00	12.00	12.00	12.00	12.00	12.00
No. of Lanes in Pocket	0	0	0	0	0	0	0	0	0	0	0	0
Pocket Length [ft]	100.00	100.00	100.00	100.00	100.00	100.00	100.00	100.00	100.00	100.00	100.00	100.00
Speed [mph]	30.00				30.00				30.00			
Grade [%]	0.00				0.00				0.00			
Crosswalk	Yes				Yes				Yes			

Volumes

Name	Hwy 1				California Ave				California Ave			
Base Volume Input [veh/h]	9	938	9	6	0	7	4	25	27	4	0	27
Base Volume Adjustment Factor	1.0000	1.0000	1.0000	1.0000	1.0000	1.0000	1.0000	1.0000	1.0000	1.0000	1.0000	1.0000
Heavy Vehicles Percentage [%]	2.00	2.00	2.00	2.00	2.00	2.00	2.00	2.00	2.00	2.00	2.00	2.00
Growth Rate	1.00	1.00	1.00	1.00	1.00	1.00	1.00	1.00	1.00	1.00	1.00	1.00
In-Process Volume [veh/h]	0	0	0	0	0	0	0	0	0	0	0	0
Site-Generated Trips [veh/h]	0	0	0	0	0	0	0	0	0	0	0	0
Diverted Trips [veh/h]	0	0	0	0	0	0	0	0	0	0	0	0
Pass-by Trips [veh/h]	0	0	0	0	0	0	0	0	0	0	0	0
Existing Site Adjustment Volume [veh/h]	0	0	0	0	0	0	0	0	0	0	0	0
Other Volume [veh/h]	0	0	0	0	0	0	0	0	0	0	0	0
Total Hourly Volume [veh/h]	9	938	9	6	0	7	4	25	27	4	0	27
Peak Hour Factor	0.9300	0.9300	0.9300	0.9300	0.9300	0.9300	0.9300	0.9300	0.9300	0.9300	0.9300	0.9300
Other Adjustment Factor	1.0000	1.0000	1.0000	1.0000	1.0000	1.0000	1.0000	1.0000	1.0000	1.0000	1.0000	1.0000
Total 15-Minute Volume [veh/h]	2	252	2	2	0	2	1	7	7	1	0	7
Total Analysis Volume [veh/h]	10	1009	10	6	0	8	4	27	29	4	0	29
Pedestrian Volume [ped/h]	0				0				0			

Intersection Settings

Number of Conflicting Circulating Lanes	1				1				1			
Circulating Flow Rate [veh/h]	74				1084				826			
Exiting Flow Rate [veh/h]	815				50				60			
Demand Flow Rate [veh/h]	9	938	9	6	0	7	4	25	27	4	0	27
Adjusted Demand Flow Rate [veh/h]	10	1009	10	6	0	8	4	27	29	4	0	29



Lanes

Overwrite Calculated Critical Headway	No				No				No			
User-Defined Critical Headway [s]	4.00				4.00				4.00			
Overwrite Calculated Follow-Up Time	No				No				No			
User-Defined Follow-Up Time [s]	3.00				3.00				3.00			
A (intercept)	1380.00				1380.00				1380.00			
B (coefficient)	0.00102				0.00102				0.00102			
HV Adjustment Factor	0.98				0.98				0.98			
Entry Flow Rate [veh/h]	1056				40				64			
Capacity of Entry and Bypass Lanes [veh/h]	1280				457				595			
Pedestrian Impedance	1.00				1.00				1.00			
Capacity per Entry Lane [veh/h]	1254				448				583			
X, volume / capacity	0.83				0.09				0.11			

Movement, Approach, & Intersection Results

Lane LOS	C				A				A			
95th-Percentile Queue Length [veh]	10.30				0.28				0.36			
95th-Percentile Queue Length [ft]	257.54				7.12				8.89			
Approach Delay [s/veh]	18.79				9.24				7.45			
Approach LOS	C				A				A			
Intersection Delay [s/veh]					14.74							
Intersection LOS					B							

Intersection Setup

Name	Hwy 1				Wienke Way			
Approach	Northwestbound				Southeastbound			
Lane Configuration								
Turning Movement	Left2	Left	Thru	Right	Left2	Left	Thru	Right
Lane Width [ft]	12.00	12.00	12.00	12.00	12.00	12.00	12.00	12.00
No. of Lanes in Pocket	0	0	0	0	0	0	0	0
Pocket Length [ft]	100.00	100.00	100.00	100.00	100.00	100.00	100.00	100.00
Speed [mph]	30.00				30.00			
Grade [%]	0.00				0.00			
Crosswalk	Yes				Yes			

Volumes

Name	Hwy 1				Wienke Way			
Base Volume Input [veh/h]	33	5	705	42	4	0	10	0
Base Volume Adjustment Factor	1.0000	1.0000	1.0000	1.0000	1.0000	1.0000	1.0000	1.0000
Heavy Vehicles Percentage [%]	2.00	2.00	2.00	2.00	2.00	2.00	2.00	2.00
Growth Rate	1.00	1.00	1.00	1.00	1.00	1.00	1.00	1.00
In-Process Volume [veh/h]	0	0	0	0	0	0	0	0
Site-Generated Trips [veh/h]	0	0	0	0	0	0	0	0
Diverted Trips [veh/h]	0	0	0	0	0	0	0	0
Pass-by Trips [veh/h]	0	0	0	0	0	0	0	0
Existing Site Adjustment Volume [veh/h]	0	0	0	0	0	0	0	0
Other Volume [veh/h]	0	0	0	0	0	0	0	0
Total Hourly Volume [veh/h]	33	5	705	42	4	0	10	0
Peak Hour Factor	0.9300	0.9300	0.9300	0.9300	0.9300	0.9300	0.9300	0.9300
Other Adjustment Factor	1.0000	1.0000	1.0000	1.0000	1.0000	1.0000	1.0000	1.0000
Total 15-Minute Volume [veh/h]	9	1	190	11	1	0	3	0
Total Analysis Volume [veh/h]	35	5	758	45	4	0	11	0
Pedestrian Volume [ped/h]	0				0			

Intersection Settings

Number of Conflicting Circulating Lanes	1				1			
Circulating Flow Rate [veh/h]	27				1119			
Exiting Flow Rate [veh/h]	1098				11			
Demand Flow Rate [veh/h]	33	5	705	42	4	0	10	0
Adjusted Demand Flow Rate [veh/h]	35	5	758	45	4	0	11	0

Lanes

Overwrite Calculated Critical Headway	No				No			
User-Defined Critical Headway [s]	4.00				4.00			
Overwrite Calculated Follow-Up Time	No				No			
User-Defined Follow-Up Time [s]	3.00				3.00			
A (intercept)	1380.00				1380.00			
B (coefficient)	0.00102				0.00102			
HV Adjustment Factor	0.98				0.98			
Entry Flow Rate [veh/h]	860				16			
Capacity of Entry and Bypass Lanes [veh/h]	1344				441			
Pedestrian Impedance	1.00				1.00			
Capacity per Entry Lane [veh/h]	1317				433			
X, volume / capacity	0.64				0.03			

Movement, Approach, & Intersection Results

Lane LOS	B				A			
95th-Percentile Queue Length [veh]	4.93				0.11			
95th-Percentile Queue Length [ft]	123.18				2.69			
Approach Delay [s/veh]	10.66				8.80			
Approach LOS	B				A			
Intersection Delay [s/veh]					14.74			
Intersection LOS					B			

Appendix 12 Background with Project Conditions, Mitigated Level-of- Service Worksheets

HCM Signalized Intersection Analysis Background plus Project Weekday AM, Mitigated
7: Highway 1 & California Avenue & Wienke Way

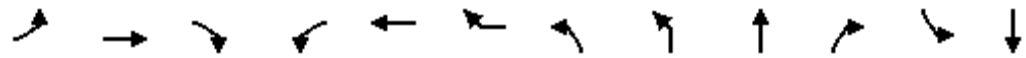

Movement	EBL	EBT	EBR	WBL	WBT	WBR	NBL2	NBL	NBT	NBR	SBL	SBT	
Lane Configurations		↕			↕		↗		↖		↗	↖	
Traffic Volume (vph)	10	0	11	48	0	15	0	4	640	21	6	592	
Future Volume (vph)	10	0	11	48	0	15	0	4	640	21	6	592	
Ideal Flow (vphpl)	1900	1900	1900	1900	1900	1900	1900	1900	1900	1900	1900	1900	
Total Lost time (s)		4.5			4.5				4.5		4.5	4.5	
Lane Util. Factor		1.00			1.00				1.00		1.00	1.00	
Frbp, ped/bikes		1.00			1.00				1.00		1.00	1.00	
Flpb, ped/bikes		1.00			1.00				1.00		1.00	1.00	
Frt		0.93			0.97				1.00		1.00	1.00	
Flt Protected		0.98			0.96				1.00		0.95	1.00	
Satd. Flow (prot)		1691			1737				1853		1770	1860	
Flt Permitted		0.86			0.76				1.00		0.29	1.00	
Satd. Flow (perm)		1487			1373				1849		542	1860	
Peak-hour factor, PHF	0.93	0.93	0.93	0.93	0.93	0.92	0.93	0.92	0.93	0.93	0.93	0.93	
Adj. Flow (vph)	11	0	12	52	0	16	0	4	688	23	6	637	
RTOR Reduction (vph)	0	20	0	0	0	0	0	0	1	0	0	0	
Lane Group Flow (vph)	0	3	0	0	68	0	0	0	714	0	6	643	
Confl. Peds. (#/hr)							1						
Turn Type	Perm	NA		Perm	NA		Perm	Perm	NA		Perm	NA	
Protected Phases		8			4				6			2	
Permitted Phases	8			4			6	6			2		
Actuated Green, G (s)		9.6			9.6				49.0		49.0	49.0	
Effective Green, g (s)		9.6			9.6				49.0		49.0	49.0	
Actuated g/C Ratio		0.13			0.13				0.65		0.65	0.65	
Clearance Time (s)		4.5			4.5				4.5		4.5	4.5	
Vehicle Extension (s)		3.0			3.0				3.0		3.0	3.0	
Lane Grp Cap (vph)		189			175				1204		353	1211	
v/s Ratio Prot												0.35	
v/s Ratio Perm		0.00			c0.05				c0.39		0.01		
v/c Ratio		0.02			0.39				0.59		0.02	0.53	
Uniform Delay, d1		28.7			30.1				7.4		4.6	7.0	
Progression Factor		1.00			1.00				1.00		1.00	1.00	
Incremental Delay, d2		0.0			1.4				0.8		0.0	0.4	
Delay (s)		28.7			31.5				8.2		4.6	7.4	
Level of Service		C			C				A		A	A	
Approach Delay (s)		28.7			31.5				8.2			7.4	
Approach LOS		C			C				A			A	
Intersection Summary													
HCM 2000 Control Delay			9.3									HCM 2000 Level of Service	A
HCM 2000 Volume to Capacity ratio			0.53										
Actuated Cycle Length (s)			75.2									Sum of lost time (s)	13.5
Intersection Capacity Utilization			51.3%									ICU Level of Service	A
Analysis Period (min)			15										
c Critical Lane Group													

HCM Signalized Intersection Analysis Background plus Project Weekday AM, Mitigated
 7: Highway 1 & California Avenue & Wienke Way



Movement	SBR	SEL
Lane Configurations		
Traffic Volume (vph)	6	0
Future Volume (vph)	6	0
Ideal Flow (vphpl)	1900	1900
Total Lost time (s)		
Lane Util. Factor		
Frbp, ped/bikes		
Flpb, ped/bikes		
Frt		
Flt Protected		
Satd. Flow (prot)		
Flt Permitted		
Satd. Flow (perm)		
Peak-hour factor, PHF	0.93	0.92
Adj. Flow (vph)	6	0
RTOR Reduction (vph)	0	0
Lane Group Flow (vph)	0	0
Confl. Peds. (#/hr)	1	
Turn Type		Prot
Protected Phases		9
Permitted Phases		
Actuated Green, G (s)		
Effective Green, g (s)		
Actuated g/C Ratio		
Clearance Time (s)		
Vehicle Extension (s)		
Lane Grp Cap (vph)		
v/s Ratio Prot		
v/s Ratio Perm		
v/c Ratio		
Uniform Delay, d1		
Progression Factor		
Incremental Delay, d2		
Delay (s)		
Level of Service		
Approach Delay (s)		0.0
Approach LOS		A
Intersection Summary		

HCM Signalized Intersection Analysis Background plus Project Weekday PM, Mitigated
 7: Highway 1 & California Avenue & Wienke Way

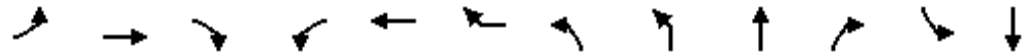

Movement	EBL	EBT	EBR	WBL	WBT	WBR	NBL2	NBL	NBT	NBR	SBL	SBT
Lane Configurations		↕			↕		↗		↖		↗	↖
Traffic Volume (vph)	3	0	3	32	0	13	0	5	734	42	17	876
Future Volume (vph)	3	0	3	32	0	13	0	5	734	42	17	876
Ideal Flow (vphpl)	1900	1900	1900	1900	1900	1900	1900	1900	1900	1900	1900	1900
Total Lost time (s)		4.5			4.5				4.5		4.5	4.5
Lane Util. Factor		1.00			1.00				1.00		1.00	1.00
Frb, ped/bikes		1.00			1.00				1.00		1.00	1.00
Flpb, ped/bikes		1.00			1.00				1.00		1.00	1.00
Frt		0.93			0.96				0.99		1.00	1.00
Flt Protected		0.98			0.97				1.00		0.95	1.00
Satd. Flow (prot)		1693			1729				1847		1770	1859
Flt Permitted		0.89			0.78				1.00		0.27	1.00
Satd. Flow (perm)		1540			1405				1840		494	1859
Peak-hour factor, PHF	0.91	0.91	0.91	0.91	0.91	0.92	0.91	0.92	0.91	0.91	0.91	0.91
Adj. Flow (vph)	3	0	3	35	0	14	0	5	807	46	19	963
RTOR Reduction (vph)	0	5	0	0	0	0	0	0	1	0	0	0
Lane Group Flow (vph)	0	1	0	0	49	0	0	0	857	0	19	974
Confl. Peds. (#/hr)	1						1					
Turn Type	Perm	NA		Perm	NA		Perm	Perm	NA		Perm	NA
Protected Phases		8			4				6			2
Permitted Phases	8			4			6	6			2	
Actuated Green, G (s)		10.4			10.4				89.5		89.5	89.5
Effective Green, g (s)		10.4			10.4				89.5		89.5	89.5
Actuated g/C Ratio		0.09			0.09				0.76		0.76	0.76
Clearance Time (s)		4.5			4.5				4.5		4.5	4.5
Vehicle Extension (s)		3.0			3.0				3.0		3.0	3.0
Lane Grp Cap (vph)		136			124				1407		377	1422
v/s Ratio Prot												c0.52
v/s Ratio Perm		0.00			c0.03				0.47		0.04	
v/c Ratio		0.00			0.40				0.61		0.05	0.68
Uniform Delay, d1		48.6			50.3				6.1		3.4	6.8
Progression Factor		1.00			1.00				1.00		1.00	1.00
Incremental Delay, d2		0.0			2.1				0.8		0.1	1.4
Delay (s)		48.6			52.4				6.8		3.4	8.2
Level of Service		D			D				A		A	A
Approach Delay (s)		48.6			52.4				6.8			8.1
Approach LOS		D			D				A			A

Intersection Summary			
HCM 2000 Control Delay	8.8	HCM 2000 Level of Service	A
HCM 2000 Volume to Capacity ratio	0.63		
Actuated Cycle Length (s)	117.0	Sum of lost time (s)	13.5
Intersection Capacity Utilization	59.0%	ICU Level of Service	B
Analysis Period (min)	15		
c Critical Lane Group			

HCM Signalized Intersection Analysis Background plus Project Weekday PM, Mitigated
 7: Highway 1 & California Avenue & Wienke Way



Movement	SBR	SEL
Lane Configurations		
Traffic Volume (vph)	10	0
Future Volume (vph)	10	0
Ideal Flow (vphpl)	1900	1900
Total Lost time (s)		
Lane Util. Factor		
Frbp, ped/bikes		
Flpb, ped/bikes		
Frt		
Flt Protected		
Satd. Flow (prot)		
Flt Permitted		
Satd. Flow (perm)		
Peak-hour factor, PHF	0.91	0.92
Adj. Flow (vph)	11	0
RTOR Reduction (vph)	0	0
Lane Group Flow (vph)	0	0
Confl. Peds. (#/hr)	1	
Turn Type		Prot
Protected Phases		9
Permitted Phases		
Actuated Green, G (s)		
Effective Green, g (s)		
Actuated g/C Ratio		
Clearance Time (s)		
Vehicle Extension (s)		
Lane Grp Cap (vph)		
v/s Ratio Prot		
v/s Ratio Perm		
v/c Ratio		
Uniform Delay, d1		
Progression Factor		
Incremental Delay, d2		
Delay (s)		
Level of Service		
Approach Delay (s)		0.0
Approach LOS		A
Intersection Summary		

HCM Signalized Intersection Analysis
7: Highway 1 & California Avenue & Wienke Way

Background plus Project Saturday, Mitigated

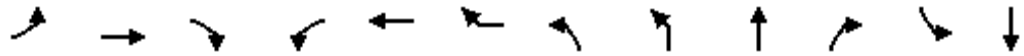

Movement	EBL	EBT	EBR	WBL	WBT	WBR	NBL2	NBL	NBT	NBR	SBL	SBT	
Lane Configurations		↕			↕		↕		↕		↕	↕	
Traffic Volume (vph)	6	3	21	23	3	23	0	28	720	36	7	953	
Future Volume (vph)	6	3	21	23	3	23	0	28	720	36	7	953	
Ideal Flow (vphpl)	1900	1900	1900	1900	1900	1900	1900	1900	1900	1900	1900	1900	
Total Lost time (s)		4.5			4.5				4.5		4.5	4.5	
Lane Util. Factor		1.00			1.00				1.00		1.00	1.00	
Frbp, ped/bikes		1.00			1.00				1.00		1.00	1.00	
Flpb, ped/bikes		1.00			1.00				1.00		1.00	1.00	
Frt		0.90			0.94				0.99		1.00	1.00	
Flt Protected		0.99			0.98				1.00		0.95	1.00	
Satd. Flow (prot)		1667			1703				1847		1770	1861	
Flt Permitted		0.94			0.84				0.94		0.28	1.00	
Satd. Flow (perm)		1588			1468				1743		531	1861	
Peak-hour factor, PHF	0.95	0.95	0.95	0.95	0.95	0.92	0.95	0.92	0.95	0.95	0.95	0.95	
Adj. Flow (vph)	6	3	22	24	3	25	0	30	758	38	7	1003	
RTOR Reduction (vph)	0	20	0	0	0	0	0	0	1	0	0	0	
Lane Group Flow (vph)	0	11	0	0	52	0	0	0	825	0	7	1010	
Confl. Peds. (#/hr)	1												
Turn Type	Perm	NA		Perm	NA		Perm	Perm	NA		Perm	NA	
Protected Phases		8			4				6			2	
Permitted Phases	8			4			6	6			2		
Actuated Green, G (s)		10.4			10.4				96.5		96.5	96.5	
Effective Green, g (s)		10.4			10.4				96.5		96.5	96.5	
Actuated g/C Ratio		0.08			0.08				0.78		0.78	0.78	
Clearance Time (s)		4.5			4.5				4.5		4.5	4.5	
Vehicle Extension (s)		3.0			3.0				3.0		3.0	3.0	
Lane Grp Cap (vph)		132			122				1354		412	1445	
v/s Ratio Prot												c0.54	
v/s Ratio Perm		0.01			c0.04				0.47		0.01		
v/c Ratio		0.08			0.43				0.61		0.02	0.70	
Uniform Delay, d1		52.5			54.1				5.9		3.1	6.8	
Progression Factor		1.00			1.00				1.00		1.00	1.00	
Incremental Delay, d2		0.3			2.4				0.8		0.0	1.5	
Delay (s)		52.8			56.5				6.7		3.1	8.3	
Level of Service		D			E				A		A	A	
Approach Delay (s)		52.8			56.5				6.7			8.2	
Approach LOS		D			E				A			A	
Intersection Summary													
HCM 2000 Control Delay			9.6									HCM 2000 Level of Service	A
HCM 2000 Volume to Capacity ratio			0.65										
Actuated Cycle Length (s)			124.2									Sum of lost time (s)	13.5
Intersection Capacity Utilization			76.8%									ICU Level of Service	D
Analysis Period (min)			15										
c Critical Lane Group													



Movement	SBR	SEL
Lane Configurations		
Traffic Volume (vph)	7	0
Future Volume (vph)	7	0
Ideal Flow (vphpl)	1900	1900
Total Lost time (s)		
Lane Util. Factor		
Frbp, ped/bikes		
Flpb, ped/bikes		
Frt		
Flt Protected		
Satd. Flow (prot)		
Flt Permitted		
Satd. Flow (perm)		
Peak-hour factor, PHF	0.95	0.92
Adj. Flow (vph)	7	0
RTOR Reduction (vph)	0	0
Lane Group Flow (vph)	0	0
Confl. Peds. (#/hr)		
Turn Type		Prot
Protected Phases		9
Permitted Phases		
Actuated Green, G (s)		
Effective Green, g (s)		
Actuated g/C Ratio		
Clearance Time (s)		
Vehicle Extension (s)		
Lane Grp Cap (vph)		
v/s Ratio Prot		
v/s Ratio Perm		
v/c Ratio		
Uniform Delay, d1		
Progression Factor		
Incremental Delay, d2		
Delay (s)		
Level of Service		
Approach Delay (s)		0.0
Approach LOS		A
Intersection Summary		

Appendix 13 Signal Warrant Analysis

Traffic Signal Warrants Worksheet

MUTCD Warrant 3: Peak Hour

Scenario: **2040 Conditions – Weekday PM Peak Hour**

Intersection: **Highway 1 & 16th Street**

PART A or PART B SATISFIED YES NO

PART A

SATISFIED YES NO

(All parts 1, 2, and 3 below must be satisfied)

- 7. The total delay experienced for traffic on one minor street approach controlled by a STOP sign equals or exceeds four vehicle-hours for a one-lane approach and five vehicle-hours for a two-lane approach; AND YES NO
- 8. The volume on the same minor street approach equals or exceeds 100 vph for one moving lane of traffic or 150 vph for two moving lanes; AND YES NO
- 9. The total entering volume serviced during the hour equals or exceeds 800 vph for intersections with four or more approaches or 650 vph for intersections with three approaches. YES NO (2,176 vph ; 4 approach)

PART B

SATISFIED YES NO

APPROACH LANES	Lanes	VPH
Both Approaches – Major Street	1	2,160
Highest Approaches – Minor Street	1	11

The plotted points for vehicles per hour on major streets (both approaches) and the corresponding per hour higher volume minor street approach (one direction only) for one hour (any consecutive 15 minute period) fall above the applicable curves in MUTCD Figure 4C-4.

Figure 4C-4. Warrant 3, Peak Hour (70% Factor)
 (COMMUNITY LESS THAN 10,000 POPULATION OR ABOVE 40 MPH ON MAJOR STREET)

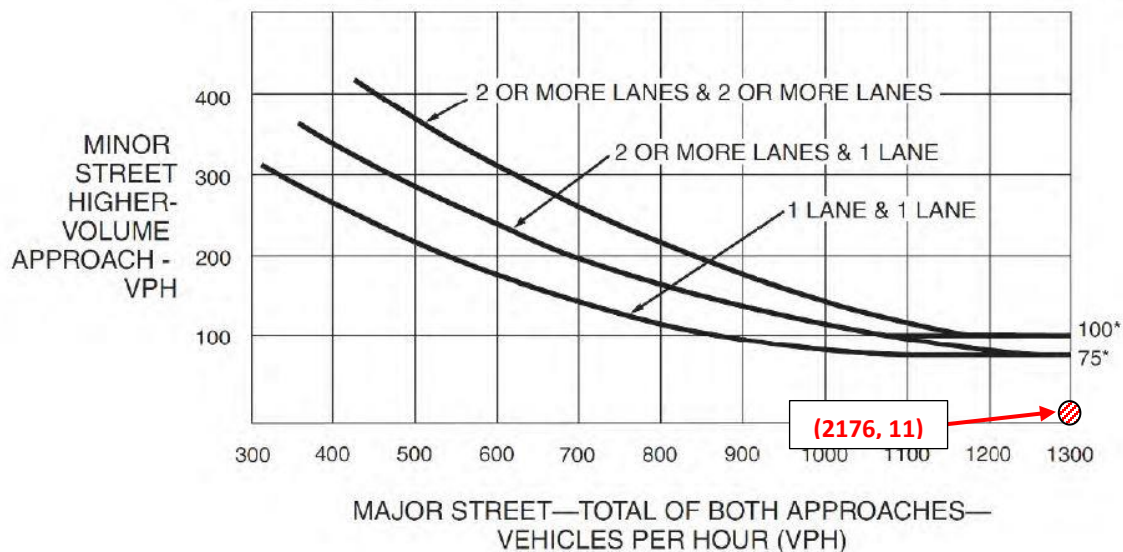

*Note: 100 vph applies as the lower threshold volume for a minor-street approach with two or more lanes and 75 vph applies as the lower threshold volume for a minor-street approach with one lane.

Traffic Signal Warrants Worksheet

MUTCD Warrant 3: Peak Hour

Scenario: **2040 Conditions – Saturday Peak Hour**

Intersection: **Highway 1 & Vallemar Street/Etheldore Street**

PART A or PART B SATISFIED YES NO

PART A

SATISFIED YES NO

(All parts 1, 2, and 3 below must be satisfied)

1. The total delay experienced for traffic on one minor street approach controlled by a STOP sign equals or exceeds four vehicle-hours for a one-lane approach and five vehicle-hours for a two-lane approach; AND YES NO
2. The volume on the same minor street approach equals or exceeds 100 vph for one moving lane of traffic or 150 vph for two moving lanes; AND YES NO
3. The total entering volume serviced during the hour equals or exceeds 800 vph for intersections with four or more approaches or 650 vph for intersections with three approaches. YES NO (1,788 vph ; 4 approach)

PART B

SATISFIED YES NO

APPROACH LANES	Lanes	VPH
Both Approaches – Major Street	1	1,727
Highest Approaches – Minor Street	1	54

The plotted points for vehicles per hour on major streets (both approaches) and the corresponding per hour higher volume minor street approach (one direction only) for one hour (any consecutive 15 minute period) fall above the applicable curves in MUTCD Figure 4C-4.

Figure 4C-4. Warrant 3, Peak Hour (70% Factor)
 (COMMUNITY LESS THAN 10,000 POPULATION OR ABOVE 40 MPH ON MAJOR STREET)

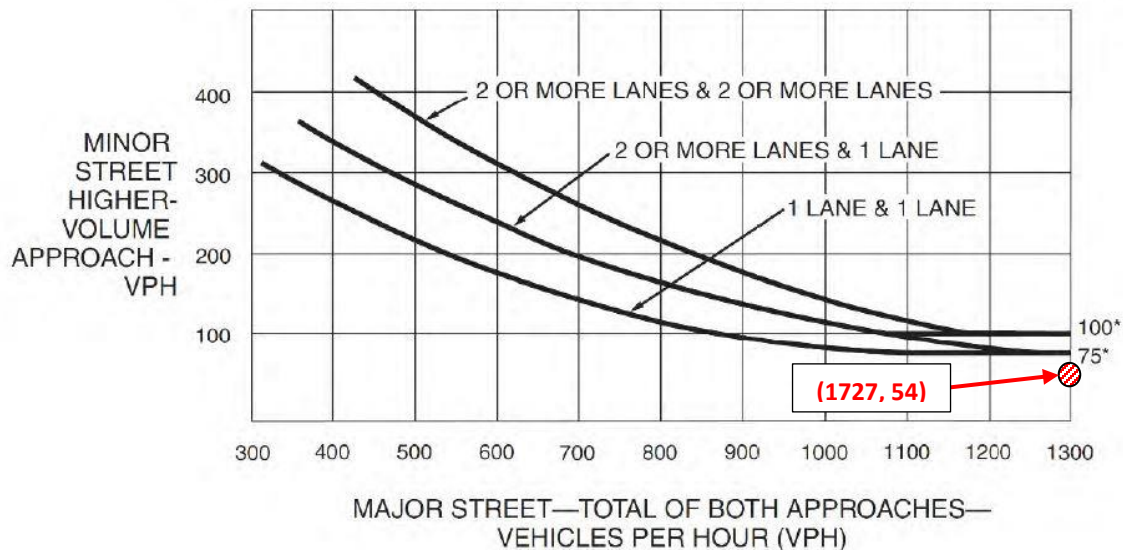

*Note: 100 vph applies as the lower threshold volume for a minor-street approach with two or more lanes and 75 vph applies as the lower threshold volume for a minor-street approach with one lane.

Appendix 14 U.S. Census Data on Midcoast Residents and Jobs

Inflow/Outflow Report

All Jobs for All Workers in 2015

Created by the U.S. Census Bureau's OnTheMap <https://onthemap.ces.census.gov> on 03/19/2019

Inflow/Outflow Counts of All Jobs for Selection Area in 2015

All Workers

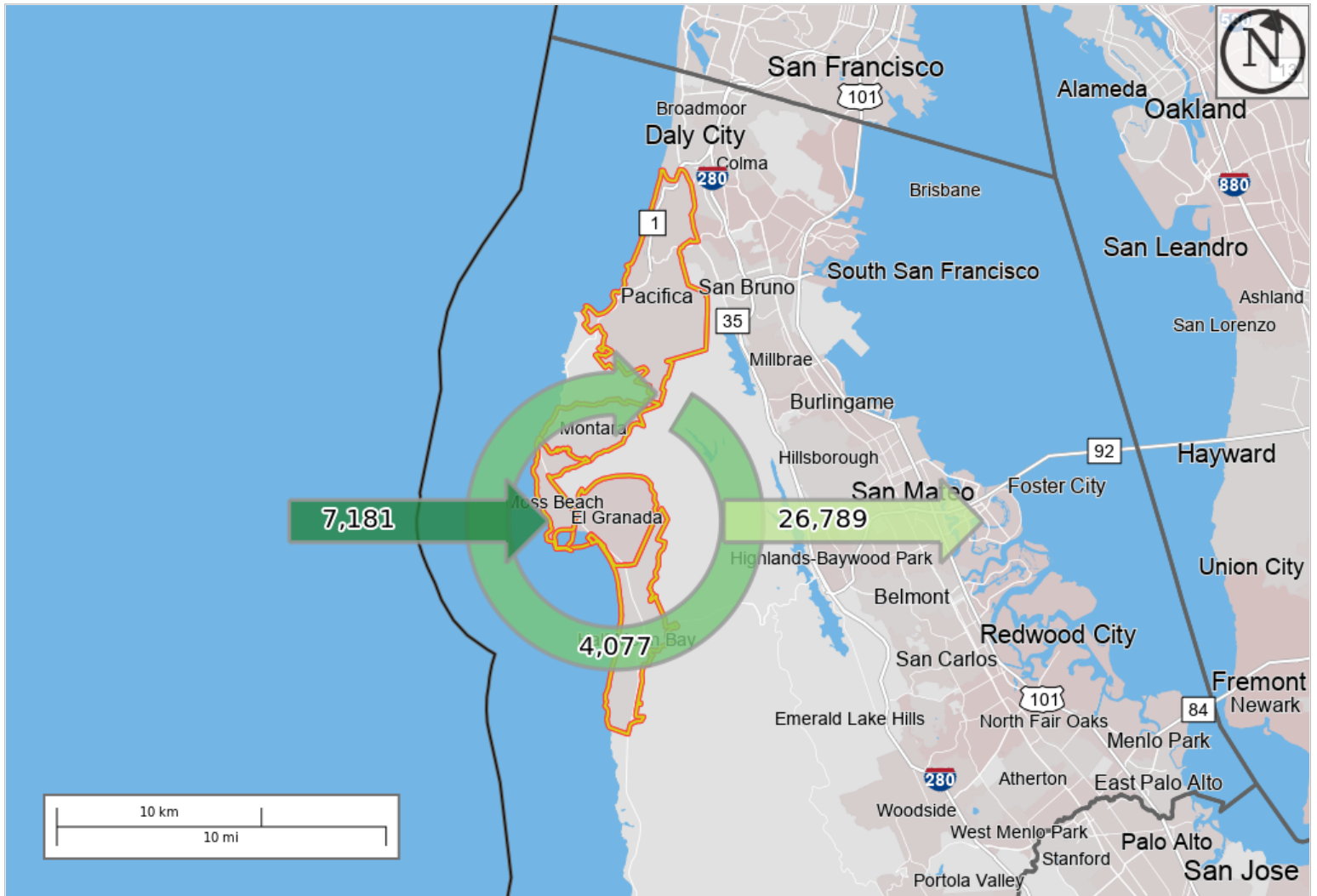

Map Legend

Selection Areas

Analysis Selection

Inflow/Outflow

- Employed and Live in Selection Area
 - Employed in Selection Area, Live Outside
 - Live in Selection Area, Employed Outside
- Note: Overlay arrows do not indicate directionality of worker flow between home and employment locations.



Inflow/Outflow Counts of All Jobs for Selection Area in 2015

All Workers

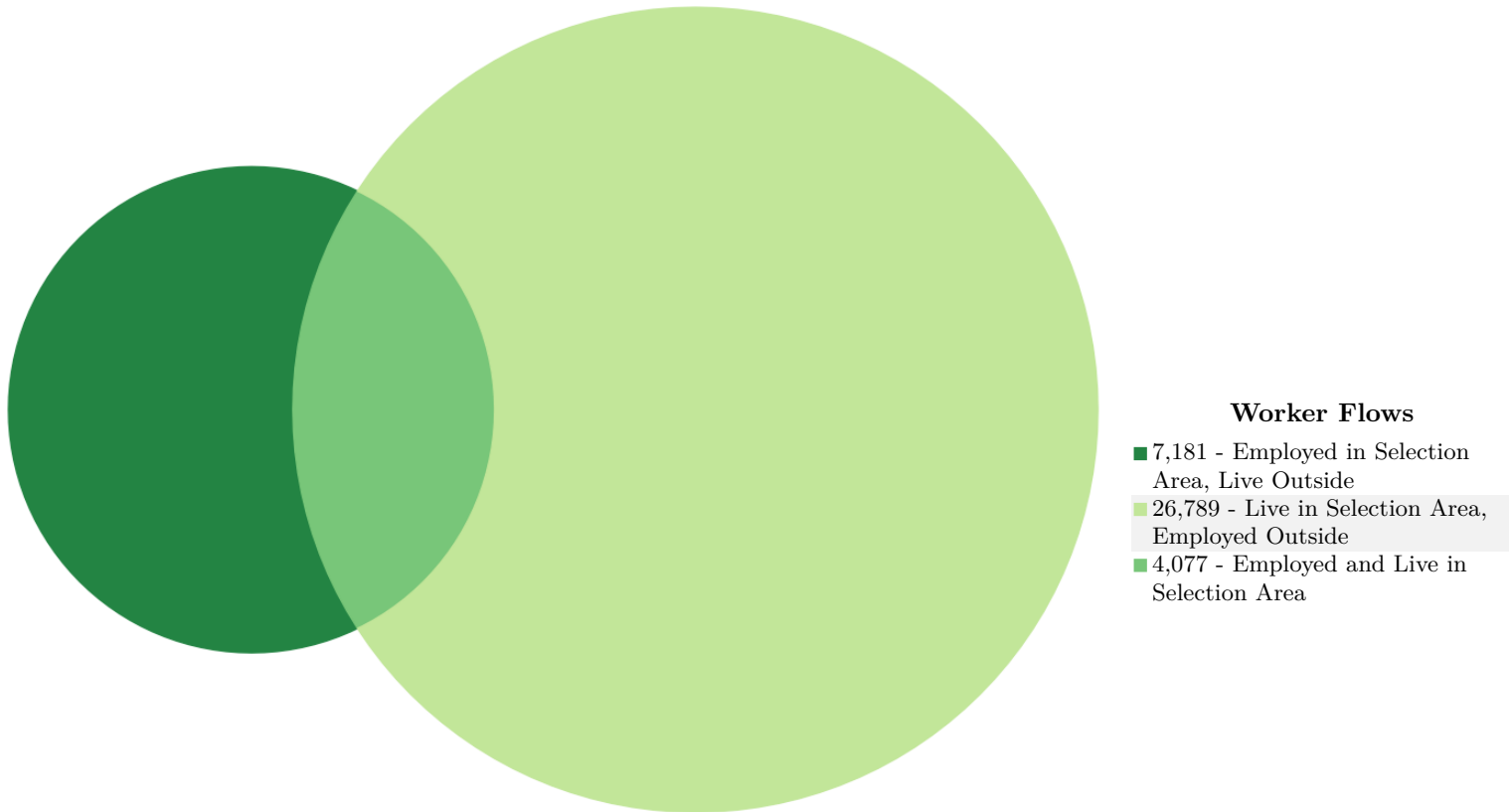

Inflow/Outflow Counts of All Jobs for Selection Area in 2015

All Workers

Worker Totals and Flows	2015	
	Count	Share
Employed in the Selection Area	11,258	100.0
Employed in the Selection Area but Living Outside	7,181	63.8
Employed and Living in the Selection Area	4,077	36.2
Living in the Selection Area	30,866	100.0
Living in the Selection Area but Employed Outside	26,789	86.8
Living and Employed in the Selection Area	4,077	13.2

Additional Information

Analysis Settings

Analysis Type	Inflow/Outflow
Selection area as	N/A
Year(s)	2015
Job Type	All Jobs
Selection Area	El Granada CDP, CA; Half Moon Bay city, CA; Pacifica city, CA; Montara CDP, CA; Moss Beach CDP, CA from Places (Cities, CDPs, etc.)
Advanced Modification	Add Selection Areas
Advanced Selection	El Granada CDP, CA; Half Moon Bay city, CA; Pacifica city, CA; Montara CDP, CA; Moss Beach CDP, CA from Places (Cities, CDPs, etc.)
Selected Census Blocks	840
Analysis Generation Date	03/19/2019 16:15 - OnTheMap 6.6
Code Revision	862b6296f5ebf0d900479b7d896f6536db69dfe7
LODES Data Version	20170818

Data Sources

Source: U.S. Census Bureau, OnTheMap Application and LEHD Origin-Destination Employment Statistics (Beginning of Quarter Employment, 2nd Quarter of 2002-2015).

Notes

1. Race, Ethnicity, Educational Attainment, and Sex statistics are beta release results and are not available before 2009.
2. Educational Attainment is only produced for workers aged 30 and over.
3. Firm Age and Firm Size statistics are beta release results for All Private jobs and are not available before 2011.

Inflow/Outflow Report

Selection Area Labor Market Size (All Jobs)

	2015	
	Count	Share
Employed in the Selection Area	11,258	100.0%
Living in the Selection Area	30,866	274.2%
Net Job Inflow (+) or Outflow (-)	-19,608	-

In-Area Labor Force Efficiency (All Jobs)

	2015	
	Count	Share
Living in the Selection Area	30,866	100.0%
Living and Employed in the Selection Area	4,077	13.2%
Living in the Selection Area but Employed Outside	26,789	86.8%

In-Area Employment Efficiency (All Jobs)

	2015	
	Count	Share
Employed in the Selection Area	11,258	100.0%
Employed and Living in the Selection Area	4,077	36.2%
Employed in the Selection Area but Living Outside	7,181	63.8%

Outflow Job Characteristics (All Jobs)

	2015	
	Count	Share
External Jobs Filled by Residents	26,789	100.0%
Workers Aged 29 or younger	4,755	17.7%
Workers Aged 30 to 54	15,084	56.3%
Workers Aged 55 or older	6,950	25.9%
Workers Earning \$1,250 per month or less	4,397	16.4%
Workers Earning \$1,251 to \$3,333 per month	5,914	22.1%
Workers Earning More than \$3,333 per month	16,478	61.5%
Workers in the "Goods Producing" Industry Class	3,162	11.8%
Workers in the "Trade, Transportation, and Utilities" Industry Class	4,954	18.5%
Workers in the "All Other Services" Industry Class	18,673	69.7%

Inflow Job Characteristics (All Jobs)

	2015	
	Count	Share
Internal Jobs Filled by Outside Workers	7,181	100.0%
Workers Aged 29 or younger	1,641	22.9%
Workers Aged 30 to 54	3,879	54.0%
Workers Aged 55 or older	1,661	23.1%
Workers Earning \$1,250 per month or less	2,124	29.6%

Inflow Job Characteristics (All Jobs)

	2015	
	Count	Share
Workers Earning \$1,251 to \$3,333 per month	2,616	36.4%
Workers Earning More than \$3,333 per month	2,441	34.0%
Workers in the "Goods Producing" Industry Class	1,029	14.3%
Workers in the "Trade, Transportation, and Utilities" Industry Class	1,080	15.0%
Workers in the "All Other Services" Industry Class	5,072	70.6%

Interior Flow Job Characteristics (All Jobs)

	2015	
	Count	Share
Internal Jobs Filled by Residents	4,077	100.0%
Workers Aged 29 or younger	1,027	25.2%
Workers Aged 30 to 54	1,942	47.6%
Workers Aged 55 or older	1,108	27.2%
Workers Earning \$1,250 per month or less	1,328	32.6%
Workers Earning \$1,251 to \$3,333 per month	1,533	37.6%
Workers Earning More than \$3,333 per month	1,216	29.8%
Workers in the "Goods Producing" Industry Class	639	15.7%

Interior Flow Job Characteristics
(All Jobs)

2015

	Count	Share
Workers in the "Trade, Transportation, and Utilities" Industry Class	555	13.6%
Workers in the "All Other Services" Industry Class	2,883	70.7%

Report Settings

Analysis Type	Inflow/Outflow
Selection area as	N/A
Year(s)	2015
Job Type	All Jobs
Selection Area	EI Granada CDP, CA; Half Moon Bay city, CA; Pacifica city, CA; Montara CDP, CA; Moss Beach CDP, CA from Places (Cities, CDPs, etc.)
Advanced Modification	Add Selection Areas
Advanced Selection	EI Granada CDP, CA; Half Moon Bay city, CA; Pacifica city, CA; Montara CDP, CA; Moss Beach CDP, CA from Places (Cities, CDPs, etc.)
Selected Census Blocks	840
Analysis Generation Date	03/19/2019 16:15 - OnTheMap 6.6
Code Revision	862b6296f5ebf0d900479b7d896f6536db69dfe7
LODES Data Version	20170818

Source: U.S. Census Bureau, OnTheMap Application and LEHD Origin-Destination Employment Statistics (Beginning of Quarter Employment, 2nd Quarter of 2002-2015).

Notes:

1. Race, Ethnicity, Educational Attainment, and Sex statistics are beta release results and are not available before 2009.
2. Educational Attainment is only produced for workers aged 30 and over.
3. Firm Age and Firm Size statistics are beta release results for All Private jobs and are not available before 2011.