



County of San Mateo - Planning and Building Department

ATTACHMENT K

**ENGINEERING GEOLOGIC &
GEOTECHNICAL INVESTIGATION
4 LOT RESIDENTIAL DEVELOPMENT
ZMAY PROPERTY
1551 CRYSTAL SPRINGS ROAD
SAN MATEO COUNTY, CALIFORNIA**

THIS REPORT HAS BEEN PREPARED FOR:

NICK ZMAY

1551 CRYSTAL SPRINGS ROAD

HILLSBOROUGH, CALIFORNIA 94010

FEBRUARY 2014

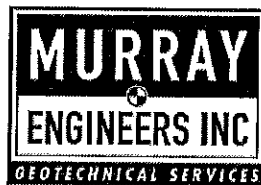

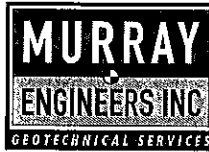

February 10, 2014
Project No. 1847-1R1

Nick Zmay
1551 Crystal Springs Road
Hillsborough, California 94010

RE: ENGINEERING GEOLOGIC &
GEOTECHNICAL INVESTIGATION,
4-LOT RESIDENTIAL DEVELOPMENT,
ZMAY PROPERTY,
1551 CRYSTAL SPRINGS ROAD,
SAN MATEO COUNTY, CALIFORNIA

Dear Mr. Zmay:

We are pleased to present the results of our engineering geologic investigation relating to the design and construction of the proposed 4-lot residential subdivision of your property located at 1551 Crystal Springs Road in San Mateo County, California. The purpose of our services was to evaluate the feasibility of the proposed residential development from both engineering geologic and geotechnical engineering perspectives. This report also summarizes the results of our field, laboratory and engineering work, and presents general recommendations for suggested foundation types and grading for the proposed residential subdivision.

While we believe that our opinions and conclusions are reasonable, it should be clearly understood that the geotechnical recommendations provided in this report are based on highly tentative plans and are for general planning purposes. Once the details of the proposed construction have been developed, we should review the design and confirm that the recommendations included in this report are still appropriate. Please note that this could result in modifications of our opinions and conclusions contained in this report.

If you have any questions concerning our investigation, please call.

Very truly yours,
MURRAY ENGINEERS, INC.

A. Nicole Roatch

A. Nicole Roatch
Senior Staff Geologist

ANR:JAS

Copies: Addressee (6)

John A. Stillman

John A. Stillman, G.E., C.E.G. 1868
Principal Geotechnical Engineer



TABLE OF CONTENTS

	Page No.
Cover Page	
Letter of Transmittal	
TABLE OF CONTENTS	
INTRODUCTION	1
Project Description	1
SCOPE OF SERVICES	2
GEOLOGIC & SEISMIC CONDITIONS.....	2
Geologic Overview.....	2
Faulting & Seismicity	3
AERIAL PHOTOGRAPH REVIEW	4
PREVIOUS GEOLOGIC & GEOTECHNICAL INVESTIGATIONS.....	5
SITE EXPLORATION AND RECONNAISSANCE	7
Exploration Program	7
Site Description	8
Landsliding	10
Subsurface.....	12
Laboratory Testing.....	13
Groundwater	13
SLOPE STABILITY ANALYSIS.....	13
CONCLUSIONS & RECOMMENDATIONS.....	15
PRELIMINARY GEOTECHNICAL RECOMMENDATIONS	18
2013 CBC EARTHQUAKE DESIGN PARAMETERS.....	19
FOUNDATIONS.....	20
Drilled Piers	20
Grouted Tieback Anchors	21
BASEMENT & SITE RETAINING WALLS	22
Lateral Earth Pressures	22
Retaining Wall Drainage	23
Backfill	24
CONCRETE SLABS	24
Structural Slabs	24
Slabs-on-Grade.....	25
Vapor Retarder Considerations	26
FLEXIBLE PAVEMENTS	27
Asphalt Driveway.....	27
Sand-Set Pavers	27
EARTHWORK.....	27
Material for Fill.....	28
Fill Subdrainage.....	29
Compaction.....	29
Final Slopes	30
Temporary Slopes, Trench Excavations & Shoring	30
SITE DRAINAGE.....	30
REQUIRED FUTURE SERVICES	31
PLAN REVIEW	31
CONSTRUCTION OBSERVATION SERVICES.....	31



TABLE OF CONTENTS

(continued)

LIMITATIONS	32
TEXT REFERENCES.....	33
AERIAL PHOTOGRAPH REFERENCES.....	34

APPENDIX A – SITE FIGURES

Figure A-1 – Vicinity Map
Figure A-2 – Partial Site Plan & Engineering Geologic Map
Figure A-3 – Vicinity Geologic Map
Figure A-4 – San Mateo County Landslide Deposit Map
Figure A-5 – San Mateo County Geotechnical Synthesis Map
Figure A-6 – Geologic Cross-Section A-A'
Figure A-7 – Geologic Cross-Section B-B'
Figure A-8 – Geologic Cross-Section C-C'
Figure A-9 – Geologic Cross-Section D-D'
Figure A-10 – Geologic Cross-Section E-E'
Figure A-11 – Cross-Section A-A' Slope Stability Analysis
Figure A-12 – Cross-Section B-B' Slope Stability Analysis
Figure A-13 – Cross-Section C-C' Slope Stability Analysis
Figure A-14 – Cross-Section D-D' Slope Stability Analysis
Figure A-15 – Cross-Section E-E' Slope Stability Analysis
Figure A-16 – Basement Subdrain System Alternative A
Figure A-17 – Basement Subdrain System Alternative B
Figure A-18 – Schematic Fill Slope Schematic

APPENDIX B – SUBSURFACE EXPLORATION

Figure B-1 – Log of Boring B-1
Figure B-2 – Log of Boring B-2
Figure B-3 – Log of Boring B-3
Figure B-4 – Log of Boring B-4
Figure B-5 – Log of Boring B-5
Figure B-6 – Log of Boring B-6
Figure B-7 – Key to Boring Logs
Figure B-8 – Unified Soil Classification System
Figure B-9 – Key to Bedrock Descriptions

APPENDIX C – SUMMARY OF LABORATORY TESTS

Figure C-1 - Liquid & Plastic Limits Test Report
Figure C-2 – Direct Shear Test Chart for Boring B-6 9-10.5 Feet BGS

APPENDIX D – BAY AREA GEOTECHNICAL GROUP (BAGG) BORING LOGS



**ENGINEERING GEOLOGIC &
GEOTECHNICAL INVESTIGATION
4-LOT RESIDENTIAL DEVELOPMENT
ZMAY PROPERTY
1551 CRYSTAL SPRINGS ROAD
SAN MATEO COUNTY, CALIFORNIA**

INTRODUCTION

This report presents the results of our engineering geologic and geotechnical investigation relating to the design and construction of a four-lot subdivision of the property located at 1551 Crystal Springs Road in San Mateo County, California. The project location is indicated on the Vicinity Map, Figure A-1. The purpose of our investigation was to evaluate the engineering geologic and geotechnical conditions on the property in the area of the proposed subdivision in order to evaluate the feasibility of the proposed subdivision, the potential impacts of geologic hazards of future site development, and to provide general geotechnical design criteria and recommendations for the project.

Project Description

The subject property is located on a steep west-facing hillside in a rural residential area of San Mateo County. The property is bounded by Parrott Drive along the uphill (east) side and Crystal Springs Road and Polhemus Road along the downhill (west) side. The proposed subdivision will split an existing approximately 60-acre lot into four approximately 2.5-acre lots for single-family residences and a "remainder lot" to be designated as open space. The proposed new residential building envelopes are to be located in the northeastern portion of the property along Parrot Drive. The details of the construction have not been formalized, but we anticipate that the residential development will include one- or two-story residences in the uphill portion of the lots and may include full or partial basements. Driveway access to the new residences will be provided off of Parrott Road. We understand that you are considering shifting the building site on Lot 1 further downslope from Parrott Drive and providing access to the new improvements along a shared access road extending across Lot 2. Site improvements will likely include retaining walls to accommodate grade changes around the new residences and along the potential driveway on Lots 1 and 2. The layout of the proposed improvements is shown on the Partial Site Plan & Engineering Geologic Map, Figure A-2.



SCOPE OF SERVICES

We performed the following services in accordance with our initial agreement dated November 7, 2013 (executed December 10, 2013):

- ❖ Reviewed published geologic maps and aerial photographs to evaluate the prevailing geologic and seismic conditions on the site and in the site vicinity
- ❖ Reviewed prior geologic and geotechnical reports for the property by Site Characteristics, Inc., dated July 1983, William Cotton and Associates, dated April 20, 1984, and Bay Area Geotechnical Group, dated December 20, 2007
- ❖ Performed an engineering geologic reconnaissance and mapping on the proposed lots and in the vicinity of the proposed improvements
- ❖ Explored the subsurface conditions by excavating, logging, and sampling six exploratory borings in the vicinity of the planned improvements
- ❖ Performed laboratory analyses and testing on selected soil samples for soil classification and to evaluate engineering properties of the subsurface materials
- ❖ Performed engineering geologic and geotechnical analyses to evaluate the relative stability of the proposed building sites and to develop general geotechnical engineering design criteria for the proposed improvements
- ❖ Prepared this report presenting a summary of our investigation and our conclusions relating to the geologic hazards that could potentially impact the site and the proposed improvements and the feasibility of the proposed improvements

GEOLOGIC & SEISMIC CONDITIONS

Geologic Overview

The property is located on a west-facing hillside in the foothills along the northeast side of the Santa Cruz Mountains, a northwest-trending range within the California Coast Ranges geomorphic province. The local topography is dominated by a series of west-trending spur ridges and intervening seasonal drainage swales. Crystal Springs Road extends along the western property boundary at the base of the hillside and converges with Polhemus Road near the southern corner of the property. San Mateo Creek and Polhemus Creek run parallel to Crystal Springs Road and Polhemus Road, respectively. Elevations across the site range from approximately 500 feet along Parrott Drive in the eastern portion of the site down to approximately 140 feet above mean sea level at the base of the hillside in the northwest corner of the site (see Figure A-1).

According to the Geologic Map of the Montara Mountain and San Mateo 7-1/2' Quadrangles (Pampeyan, 1994), the site is located in an area underlain by Cretaceous and Jurassic age (approximately 65 to 200 million years old) sheared rock of the Franciscan Complex (fsr).



The sheared rock generally consists of soft, light- to dark-gray, sheared shale, siltstone, and greywacke sandstone containing various-size tectonic inclusions of Franciscan rock types. According to the geologic map, the lower portion of the slope in the northwest corner of the property is blanketed by Quaternary slope wash, ravine fill and colluvium deposits (Qsr). These deposits generally consist of unconsolidated to moderately consolidated sand, silt, clay, and rock fragments accumulated by slow downslope movement of weathered rock debris and soil. A copy of the relevant portion of the geologic map is presented on Figure A-3, Vicinity Geologic Map.

According to the geologic map, the Geotechnical Hazard Synthesis Map for San Mateo County (Leighton and Associates, 1976), and the Preliminary Map of Landslide Deposits in San Mateo County (Brabb & Pampeyan, 1972), three relatively large landslides are mapped in the central portion of the property. According to the geologic map, the largest feature measures approximately 900 feet in length and 600 feet in width. The upper margin of this feature is located approximately 350 feet to the west (downhill) of Parrott Drive and extends down to Crystal Springs Road, crossing the southwest corner of Lot 4. The second mapped landslide is approximately 700 feet long and 500 feet wide and is located immediately south of the first landslide. In addition, smaller landslide features are mapped in the southern portion of the lot and at the northeast corner just off the property. The relevant portions of these maps are included as Figure A-4, San Mateo County Landslide Map and Figure A-5, San Mateo County Geotechnical Hazard Synthesis Map.

Faulting & Seismicity

Geologists and seismologists recognize the San Francisco Bay Area as one of the most active seismic regions in the United States. There are three major faults that trend in a northwest direction through the Bay Area, which have generated about 12 earthquakes per century large enough to cause significant structural damage. These earthquakes occur on faults that are part of the San Andreas fault system, which extends for at least 700 miles along the California Coast and includes the San Andreas, San Gregorio, Hayward, and Calaveras faults. The San Andreas and San Gregorio faults are located approximately 1.1 and 8.3 miles southwest of the site, respectively. The Hayward and Calaveras faults are located approximately 17 and 25 miles northeast of the site, respectively.

Seismologic and geologic experts convened by the U. S. Geological Survey, California Geological Survey, and the Southern California Earthquake Center conclude that there is a 63 percent probability for at least one "large" earthquake of magnitude 6.7 or larger in the Bay Area before the year 2038. The northern portion of the San Andreas fault is estimated to have a 21 percent probability of producing a magnitude 6.7 or larger earthquake by the year 2038 (2007 WGCEP, 2008).

AERIAL PHOTOGRAPH REVIEW

Three sets of historical aerial photographs taken between 1943 and 1974 were reviewed at the U.S. Geologic Survey's library in Menlo Park to aid in evaluating the presence of geomorphic features that may be suggestive of landsliding. The site is readily identifiable in all of the photographs, based on the topography and the location of Parrott Drive, Crystal Springs Road, and Polhemus Road. Other than the development of the neighboring residential properties, there is very little change in the vicinity of the property during the period covered by the photographs. In the 1948 photographs, the streets are present but there is no other development in the vicinity of the property. By the time of the 1968 photographs, most of the homes along Parrott Drive are complete and the building pad on the property immediately north of Lot 1 appears to be graded. In addition, it appears that improvements were made to Parrott Drive and that additional fill was placed along the downhill side of the roadway. The residences to the north of Lot 1 and south of Lot 4 are present by the time of the 1974 photographs.

In the 1943 photographs, two large landslides are present in the central portion of the property, similar to mapping by Pampeyan (see Figure A-3). The landslides are characterized by broad arcuate topography extending from the downhill side of Parrott Drive down to Crystal Springs Road. The northernmost feature crosses the southwest portion of Lot 4, more than 150 feet southwest of the proposed residence (see Figure A-2). The ground surface within the limits of the landslides is generally hummocky with irregular medium to dense vegetation. A small debris flow appears to be located within the limits of the northern landslide. In addition, a debris flow is located uphill of the southern landslide and drops into the upper portion of the landslide feature. The landslide masses are confined by drainage swales extending down the margins of the features to Crystal Springs Road. In addition, a large debris flow-type landslide, also mapped by Pampeyan, is located in the southern portion of the property.

In the 1968 photographs, an access road is present on Lots 1 and 2. This road enters Lot 2 from Parrott Drive, extends across the uphill portion of Lot 1 and to the graded pad on the adjacent northern property. It appears that sometime between 1968 and 1974, a small landslide occurred along the downhill side of the access road along the boundary between Lots 1 and 2. A headscarp is present along the uphill margin of this arcuate feature in the 1974 photographs. No evidence of landsliding was observed immediately east of this feature, however, there is a tonal variation in the vegetation and the topography has a very subdued arcuate shape, suggesting that this area may be prone to shallow sliding.

The drainage swale in the lower portion of Lot 2 is densely vegetated. There is no conclusive evidence in the photographs to suggest that debris flows have occurred along this swale.

A deep drainage ravine extends from the southeast to northwest corners of Lot 4. This feature appears to be confined by a relatively resistant ridge to the south, and then by the northern margin of the large landslide on the slope below Lot 4. This feature is present in the 1943 and 1968 photographs and by the time of the 1974 photographs a storm drain culvert appears to have been constructed along the downhill side of Parrott Drive. The head of the swale appears to be larger in the latest photographs, and is presumably related to grading during construction of the storm drain culvert. The drainage ravine is densely vegetated and any evidence of landsliding or debris flows is obscured.

PREVIOUS GEOLOGIC & GEOTECHNICAL INVESTIGATIONS

Site Characteristics, Inc. (SCI) conducted a geotechnical investigation on the property, dated July 1983, to address three proposed single family residences along Crystal Springs Road in the northwest lower portion of the property. SCI performed a site reconnaissance and mapped a small active landslide below the graded access road on Lot 1 and a relatively small active landslide above the storm drain culvert on Lot 4. In addition, they mapped several shallow features on the slope below the proposed lots. As part of the investigation, SCI excavated and logged seven test pits in the area of the proposed improvements. In general, the test pits exposed variable amounts of colluvium ranging from 1 to 12 feet in thickness underlain by bedrock materials associated with the Franciscan Complex. SCI indicated that there was no evidence of recent slope instability or soil creep in the proposed building site areas, with the exception of Building Site 1, located at the base of the drainage swale along the northern margin of the large mapped landslide. SCI recommended supporting the residences on 12-inch diameter piers, extending at least 8 feet into competent materials. In addition, SCI recommended constructing an earth flow deflection wall above Building Site 1.

Subsequently, William Cotton and Associates (WCA) performed a supplemental geotechnical analysis and presented the results in a report dated April 20, 1984. As part of their investigation, WCA performed a site reconnaissance and mapping, aerial photograph review, and shallow and deep slope stability analyses. WCA observed several small earth slumps on the property, including the active landslide on Lots 1 and 2, but indicated that there was no evidence of debris flows on the property. WCA noted two areas on the proposed lots that may be potentially susceptible to shallow translational sliding and debris flows, including the head of the drainage ravine on Lot 4 and the eastern portion of Lot 3, and an area on Lots 1 and 2 extending from Parrott Drive to the drainage swale below and encompassing the active landslide.

Based on a review of SCI's subsurface exploration data, WCA concluded that the landslide material is composed of a relatively large block, or blocks, of intact bedrock materials and is

likely a rock slump that occurred several thousands of years ago. WCA performed a slope stability analysis through the large mapped landslide and reported a factor of safety of 2.5 for static conditions and 1.1 for seismic conditions. WCA concluded that the proposed building site is likely situated on top of an ancient landslide, but based on the slope stability analysis the landslide deposit should remain stable. WCA recommended the construction of a deflection wall at the northeast corner of the proposed residence and improvement of the drainage channel in that area.

In 2007, Bay Area Geotechnical Group (BAGG) performed a geotechnical and engineering geologic investigation for a proposed 20-lot residential subdivision of the subject property. The results of the investigation were presented in a report dated December 20, 2007. As part of the investigation, BAGG excavated six relatively deep borings within the landslide areas and nine additional borings on the remaining portions of the property, and performed laboratory testing on samples, including triaxial shear and direct shear testing. Three of the borings were advanced on Lot 1, one of which is located within the limits of the presumably active landslide, and two were located on the slope below Lots 2 and 4. The locations of these borings are shown on Figure A-2 and the boring logs are included in this report as Appendix D.

In general, BAGG's borings encountered approximately 5 feet of colluvial soil underlain by bedrock associated with the Franciscan Complex. Boring EB-1, located immediately above the head scarp of the active landslide on Lot 1, encountered approximately 4 feet of colluvial soil consisting of sandy lean clay and clayey sand. Mélange bedrock was encountered below the colluvium and persisted to the bottom of the boring at a depth of 24 feet, where effective drilling refusal was encountered. Boring EB-10, located downslope of EB-1 and within the limits of the active landslide, encountered approximately 6.5 feet of sandy clay colluvium underlain by mélange bedrock. Sandstone was encountered at a depth of 10 feet and persisted to the bottom of the boring at a depth of 15.5 feet. Borings EB-2 and EB-3, located below Lot 2 and in the western (downhill) portion of Lot 1, respectively, encountered approximately 7 to 8 feet of sandy lean clay. In Boring EB-2 the clay is underlain by a 10-foot thick layer of clayey sand with fine gravel and in Boring EB-3 the lean clay is underlain by an approximately 4-foot thick layer of fat clay with gravel. Mélange was encountered below the colluvium at a depth of 17.5 and 12 feet, respectively, and the borings were terminated at depths of approximately 21.5 and 19 feet. Boring ERWB-2, located downhill from Lot 4, encountered approximately 5.5 feet of sandy lean clay underlain by mélange that persisted to the bottom of the boring at a depth of 97.5 feet. The mélange generally consisted of Franciscan shale and sandstone fragments in a clayey matrix.

BAGG performed slope stability analyses and Newmark analyses through the two large landslide areas in the central portion of the property. The stability analyses utilized Bishop's

simplified method to evaluate a circular failure surface. Strength values used in the analysis were obtained by laboratory testing of samples from the exploratory borings. In general, the softer materials were chosen to perform shear strength testing due to the impracticality of obtaining undisturbed samples of the harder bedrock material. BAGG indicated that bedrock samples obtained across the site varied from minimal to up to 60 percent hard rock in a clayey matrix and borings within the large landslide areas encountered bedrock consisting of 22 to 31 percent hard rock. BAGG assumed that a higher percentage of blocks would add strength to the matrix since the failure surface would have to distort around the blocks and increased the friction angle by up to 7½ degrees, based on the percentage of hard rock, to more realistically represent the strength of the bedrock. Without increasing the friction of the matrix, the slope stability analysis yielded factors of safety against sliding in excess of 1.68 under dry conditions and 1.01 under saturated conditions. In general, factors of safety greater than 1.0 indicate a stable condition, while factors of safety less than 1.0 indicate an unstable condition. The critical failure surface extends up to 80 to 100 feet below the hillside. BAGG concluded that it was unlikely that rain could saturate the slope to this depth, but indicated that there is a potential for shallow soil slumps to occur. Based on their Newmark analyses, BAGG concluded that the two mapped slide areas could move from 6 to 18 inches. Based on their assessment, BAGG concluded that there was a significant risk of seismic slope instability within the two mapped slide areas; however, development of the remaining portions of the site where there is no evidence of deep-seated slope movement is feasible from a geotechnical engineering standpoint.

Based on their investigation, BAGG recommended supporting the proposed residences on drilled piers at least 15 feet in depth and extend a minimum of 10 feet into firm native soils and/or bedrock.

SITE EXPLORATION AND RECONNAISSANCE

Exploration Program

An initial site visit was performed by our principal geotechnical engineer on October 23, 2013. Subsequently, on December 17 and 20, 2013 our senior staff geologist visited the site to perform a site reconnaissance and engineering geologic mapping. Our subsurface field investigation was performed on December 20 and 23, 2013 and included the excavation and logging of six exploratory borings to depths ranging from 18 to 40 feet at the locations shown on Figure A-2. Two borings were located above and within the active landslide on Lot 1, and one boring was advanced on each of the four lots in the vicinity of the proposed building sites. The boring locations were approximately determined by measuring distance and bearing from known points on the supplied site plan using a tape measure and compass,



and should be considered accurate only to the degree implied by the mapping technique used.

The borings were advanced using a track-mounted CME-55 drill rig equipped with 6-inch diameter continuous flight augers. Intermittent soil samples were collected with split-spoon samplers that were driven with a 140-pound hammer repeatedly dropped from a height of 30 inches using a pneumatic hammer. The number of hammer blows required to drive the samplers were recorded in 6-inch increments for the length of the 18-inch long sampler barrels. The associated blow count data, which is the sum of the second and third 6-inch increment, is presented on the boring logs as sampling resistance in blows per foot. The blow counts for the 3-inch and 2.5-inch samplers have been standardized to Standard Penetration Test blow counts for sampler size; however, they have not been adjusted for other factors, such as hammer efficiency. Logs of the borings are presented in Appendix B as Figures B-1 through B-6. Also included in Appendix B are Figure B-7, Key to Boring Logs; Figure B-8, Unified Soil Classification System; and Figure B-9, Key to Bedrock Descriptions.

Our staff geologist logged the borings in general accordance with the Unified Soil Classification System and Key to Bedrock Descriptions. The boring logs show our interpretation of the subsurface conditions at the location and on the date indicated and it is not warranted that these conditions are representative of the subsurface conditions at other locations and times. In addition, the stratification lines shown on the logs represent approximate boundaries between the soil materials; however, the transitions may be gradual. Samples recovered from the borings were reviewed by our senior staff geologist and principal geotechnical engineer.

Site Description

The irregular-shaped, approximately 60.3-acre property measures approximately 3,500 feet wide along Crystal Springs Road and Polhemus Road, and up to 1,300 feet deep. The site is bounded to the west by Crystal Springs Road and Polhemus Road, to the east by Parrott Drive, and developed and undeveloped residential properties on all other sides. The property is situated on the western flank of a south- to southeast-trending ridgeline. San Mateo Creek and Polhemus Creek run along the base of the ridgeline and converge near the southern corner of the property. The site topography is dominated by a series of westerly-trending spur ridges and intervening drainage swales. The natural ground surface across the property is generally steep with gradients varying from 2:1 to 3:1 (horizontal to vertical) and moderately sloping across portions of the mapped slides with gradients ranging from approximately 4:1 to 5:1. Locally steeper than 2:1 slopes are present, however. Maximum vertical relief across the property is approximately 400 feet from the base of the hillside near

the northwest corner of the property up to the upper, eastern property line (see Figures A-1 & A-2).

The proposed 2.5-acre lots are located in the northeast corner of the property, along Parrott Drive. Lot 1 is located on the southern flank of a west-trending spur ridge. The ground surface in the upper portion of the property slopes moderately toward the southwest with gradients of approximately 3:1 to 4:1 and slopes steeply toward the west in the downhill portion of the property with gradients of approximately 2:1 to 3:1. A wedge of fill up to approximately 25 feet tall is located along the downhill side of Parrott Drive and slopes steeply with a gradient of approximately 2:1 (see Figure A-2 and Figure A-6, Geologic Cross-Section A-A'). In addition, it appears that a minor amount fill was placed along the northern property boundary during grading for the adjacent property to the north.

An active landslide is located along the property boundary between Lots 1 and 2. This feature measures up to approximately 160 feet in width and 200 feet in length. An approximately 4- to 5-foot tall headscarp exposing sandy silt is located along the uphill margin of the feature and the ground surface within the slide is very hummocky and saturated. The ground surface within the limits of the active landslide range from approximately 4:1 across the uphill portion of the feature to approximately 2:1 across the downhill portion (see Figure A-2 and Figure A-7, Geologic Cross-Section B-B'). Additional discussion of the landsliding on the proposed lots is included in the Landsliding section below. The vegetation within the landslide generally consists of pompous grass and poison oak. The remaining portions of Lot 1 are vegetated with native grasses, shrubs, and some scattered trees.

Lot 2 is situated across a subdued west-trending spur ridge and a drainage swale. The active landslide discussed above is located within the drainage swale along the northern property boundary. The ground surface across the ridgeline slopes steeply toward the west with gradients of approximately 2.5:1 (see Figure A-2 and Figure A-8, Geologic Cross-Section C-C'). A wedge of fill up to approximately 12 feet tall is located along the downhill side of Parrott Drive and slopes steeply with a gradient of approximately 2:1. An access road extends from Parrott Drive at the southeast corner of the property to the head of the landslide near the northern property boundary. It appears that a thin wedge of fill was placed along the downhill side of the access road during grading. In general, the ridgeline is vegetated with tall grasses and scattered trees and shrubs. In addition, the head of a debris flow is located in the drainage swale at the westernmost downslope end of the property (see figure A-2). The drainage swale and adjacent slopes are densely vegetated with poison oak, trees, and tall pompous grass.

Lot 3 is located across the crest and southern flank of a west-trending spur ridge. The ground surface across the ridgeline slopes steeply toward the west with gradients of approximately 2:1 to 3:1. Along the southern flank, the ground surface is irregular and suggestive of shallow soil creep with very steep slopes ranging from 1.5:1 to 2:1 (see Figure A-2 and Figure A-9, Geologic Cross-Section D-D'). A thin wedge of fill is located along the downhill side of Parrott Drive. In general, the ridgeline is vegetated with grasses, scattered trees and shrubs. The southern flank is densely vegetated with trees and associated underbrush.

Lot 4 is situated across a drainage ravine confined between two west-trending spur ridges. A storm drain culvert is located at the southeast corner of the property and the drainage ravine extends to the northwest corner of the lot. The slopes around the culvert are very steep to precipitous and the culvert is obscured by an abundant growth of poison oak. The drainage ravine is approximately 5 to 8 feet deep and sandstone and sheared rock exposures were observed along sections of the drainage ravine. The ravine was dry at the time of our site reconnaissance. The ridgeline to the south of the ravine appears to be relatively resistant to erosion and is a prominent feature compared to the spur ridges on Lots 1 through 3. The ground surface across the ridgeline slopes steeply to the west with gradients of approximately 2:1 to 1.5:1 (see Figure A-2 and Figure A-10, Geologic Cross-Section E-E'). In the southwest corner of the property, the ridgeline is truncated by a large presumably ancient landslide. The ground surface within the slide area is irregular and the slopes range from 3:1 to 10:1. The slopes across the southern flank in the northeast portion of the property slope steeply toward the drainage ravine with slopes ranging from 1.5:1 to 2:1. In general, the topography along either side of the drainage ravine is suggestive of shallow landsliding and/or debris flows.

Landsliding

As discussed above, a large presumably ancient landslide appears to extend from the downhill side of Parrott Drive across the southwest corner of Lot 4 and to Crystal Springs Road. This feature is approximately 500 feet in width and 1,200 feet in length and, based on our aerial photograph review, appears to have occurred prior to development of the area. This feature crosses the southwest corner of Lot 4; however, it is located on the opposite site of a resistant ridgeline more than 150 feet downslope from the proposed building site. Further discussion of the slope stability analysis performed by BAGG is included in the Previous Geologic & Geotechnical Investigations section above.

As noted above, BAGG mapped an older landslide in the upper portion of Lot 1. One exploratory boring, Boring B-4, was advanced in the center of this feature and encountered bedrock at a depth of 18 inches. Based on our review of aerial photographs, our site reconnaissance, and subsurface exploration, in our opinion there appears to be no strong

evidence to support the presence of this feature. We note that this feature was also not identified by SCI or WCA.

An active relatively shallow landslide is located along the property boundary between Lots 1 and 2. This feature was initially mapped by SCI in 1983. Based on our review of aerial photographs and our site reconnaissance, it appears that this feature is larger than initially mapped by SCI. It appears that a 40-foot wide failure appears to have occurred along the downhill side of the graded access road on Lot 2, widening the area of the active landslide. This active landslide was absent from the 1943 and 1968 aerial photographs, but appeared in the latest photographs following construction of the graded access road. In our opinion, grading associated with construction of this road is likely the main probable cause of the landslide. Based on our subsurface exploration, it appears that this active landslide is less than 10 feet thick in depth.

A debris flow was initially mapped by SCI along the drainage swale below Lot 2; however, this was refuted by WCA. This feature was subsequently mapped by BAGG, with the upper limit extending approximately 60 feet onto Lot 2. Based on our site reconnaissance and aerial photograph review, a significant amount of erosion has occurred at the head of this feature; however, very dense vegetation obscures the topography. In our opinion, if this feature were to move, it is located sufficiently away from the proposed building site that it would have little to no impact on the proposed improvements.

For reference purposes, debris flows, in general, commonly involve upon saturation, the rapid removal of relatively shallow thicknesses of granular soil over a firm contact such as bedrock. The saturated soil is transported, in semi-liquid form, from the upper regions of the debris flow causing a scar to form in this area, and the resulting debris deposited along a relatively narrow band or "pathway" to a termination point below. Depending on many factors including the size, steepness of slope, topography, soil type, etc., structures located immediately below slopes potentially prone to debris flow movement may be in an immediate threat of both structural damage and/or life safety. Mitigation measures such as debris fences, impact walls, or deflection walls are commonly recommended to reduce this potential threat.

Shallow debris flows also appear to have occurred along the drainage ravine on Lot 4, as evidenced by evacuated head scarps along the northern side of the channel. It appears that these features are related to very steep to precipitous slopes along either side of the ravine in addition to heavy precipitation during past rainfall events. The deeply incised drainage ravine suggests that a large volume of water flows through the culvert during the rainy season. A relatively small active landslide was mapped above the culvert by CSI; however,

while evidence of erosion was observed around the culvert, we did not observe any evidence of an active landslide.

We note that due to the dense vegetation and steep slope conditions, only portions of the site was accessed by our firm during our site reconnaissance and mapping phase. Therefore, there could be other shallow slope failures on the property that were not documented by our firm.

Subsurface

In general, the exploratory borings encountered variable amounts of fill and colluvium underlain by sandstone and sheared rock from the surface to the full depth explored of 40 feet. The boring locations are presented on Figure A-2, Partial Site Plan & Engineering Geologic Map and detailed logs of each boring are presented in Appendix B. A general description of the subsurface conditions and the approximate location of each exploratory boring are described hereunder.

Borings B-1 and B-2, located along the uphill side of the proposed building sites on Lot 3 and 4, respectively, encountered approximately 4 to 6.5 feet of stiff to hard sandy silt fill underlain by approximately 2.5 to 4.5 feet of colluvial soil consisting of very stiff to hard sandy silt. Sandstone bedrock was encountered below the colluvium at a depth of 6.5 and 11 feet, respectively, and persisted to a depth of 33 and 28.5 feet. The sandstone bedrock is underlain by sheared rock that persisted to the bottom of the borings at a depth of 40 feet.

Boring B-3, located along the uphill side of the proposed building site on Lot 2, encountered approximately 5 feet of colluvium consisting of stiff to very stiff sandy silt and silty clay. Sandstone bedrock was encountered at a depth of 5 feet and persisted to the bottom of the boring at a depth of 35 feet.

Boring B-4, located along the downhill side of the proposed building site on Lot 1, encountered approximately 18 inches of colluvial soil consisting of stiff sandy silt underlain by sandstone bedrock. The sandstone bedrock persisted to a depth of 30 feet and was, in turn, underlain by sheared rock. The sheared rock persisted to the bottom of the boring at a depth of 38.6 feet.

Boring B-5, located immediately upslope of the active landslide on Lot 1, encountered approximately 5 feet of very stiff sandy silt colluvium underlain by sandstone bedrock. Sheared rock was encountered at a depth of 13.5 feet and persisted to the bottom of the boring at a depth of 22.7 feet.

Boring B-6, located within the limits of the active landslide on Lot 1, encountered approximately 9.5 feet of active landslide deposits consisting of medium stiff to very stiff sandy silt. Sheared rock was encountered below the landslide deposits and persisted to a depth of 18.1 feet.

Laboratory Testing

Atterberg Limits testing was performed on two samples of the surficial soil from Boring B-3 at a depth of 1.5 to 3 feet and Boring B-6 at a depth of 3 to 4.5 feet to evaluate the expansion potential of this material. The testing yielded a liquid limit of 41 and 29 percent, respectively, and a plasticity index of 22 and 11 indicating that this material has a low to moderate potential for expansion (see Figure C-1, Liquid & Plastic Limits Test Report).

Groundwater

Groundwater was encountered in Borings B-4, B-5 and B-6 at the time of drilling at a depth of approximately 28, 18 and 6.5 feet, respectively. Free groundwater was not encountered in any of the other borings. We note that fluctuations in the level of groundwater can occur due to variations in rainfall, temperature, landscaping, and other factors that may not have been evident at the time our observations were made.

SLOPE STABILITY ANALYSIS

A seismic slope stability screening analysis was performed in general accordance with the guidelines outlined in the following publications:

- ❖ Special Publication 117A: Guidelines for Evaluating and Mitigating Seismic Hazards in California (California Geological Survey, 2008)
- ❖ Recommended Procedures for Implementation of DMG Special Publication 117 - Guidelines for Analyzing and Mitigating Landslide Hazards in California (Blake and others, 2002)

The screening analysis included a pseudo-static analysis to evaluate the overall seismic deep-seated stability of Lots 1 through 4 in the vicinity of the proposed building sites along Cross-Sections A-A', C-C', D-D', and E-E' (see Figures A-6, A-8, A-9 and A-10) and of the active landslide on Lots 1 and 2 along Cross Section B-B' (see Figure A-7). The analyses were performed using the computer program Slide 5.0, utilizing the Modified Bishop method to search for the critical circular failure surface and calculate the factor of safety. The critical failure surface is defined as the surface with the lowest calculated factor of safety. In general, factors of safety greater than 1.0 indicate a stable condition, while factors of safety less than

1.0 indicate an unstable condition. The pseudo-static analyses utilized a seismic coefficient (k) of approximately 0.27, determined in general accordance with Special Publication 117A for a threshold displacement of 15 centimeters using a peak ground acceleration of 0.57 obtained from the interactive U.S. Geological Survey Earthquake Hazards Program web site (U.S. Geological Survey, 2008). As a state seismic hazard zones report is not available for the San Mateo quadrangle, we utilized a magnitude of 7.9 taken from the Seismic Hazard Zone Report for the adjacent Palo Alto Quadrangle (California Geological Survey, 2006).

Subsurface conditions were approximated based on local geologic maps, our site reconnaissance, and subsurface data collected by our firm and by BAGG. Specifically, the proposed lots are blanketed by colluvial soil underlain by Franciscan Complex bedrock. Strength values used in the analysis were obtained from Table 2.1 of the Seismic Hazard Zone Report for the Palo Alto Quadrangle in conjunction with laboratory testing on samples from our subsurface borings and strength values reported by BAGG.

For the native soils and shallow, softer bedrock materials, BAGG estimated cohesion values of 2,540 and 935 pounds per square foot (psf) and a phi value of 36 and 40 degrees. The Seismic Hazard Zone Report indicates that strength values for Holocene aged deposits range from 500 to 700 psf with a phi value of 21 to 26 degrees. Our analysis utilized much more conservative values, including a phi value of 29 degrees and a cohesion value of 350 psf for the surficial soils. We also utilized the same strength parameters for the active landslide present on Lots 1 & 2 with the assumption that the upper portions of this feature will be stabilized (see recommendations below).

According to the referenced Seismic Hazard Zone Report, the Franciscan Complex bedrock materials have a cohesion value of 650 psf and a phi value of 29 degrees. Direct shear testing on a sample of the bedrock obtained from Boring B-6 between the depths of 9 to 10.5 feet yielded a phi value of 15.6 degrees and a cohesion value of 700 psf (see Figure C-2, Direct Shear Test Chart for Boring B-7 9-10.5 Feet BGS). In our opinion, the results of the direct shear testing are likely low due to disturbance of the samples during drilling. In addition, we note that strength testing by BAGG yielded much higher values which accounts for increase in strength from having to shear or distort around hard bedrock blocks. Therefore, our analysis utilized a cohesion value of 850 and a phi value of 29 degrees to more conservatively represent the strength of the bedrock. Based on our subsurface exploration and because of the elevated topographic position of the site, it is our opinion that the potential for high groundwater at the site is low. Therefore, we did not include a high groundwater level as part of the analysis.

The stability analyses yielded critical failure surfaces extending through the bedrock with a calculated factor of safety ranging from 1.00 to 1.39. The results of the slope stability

analyses are included as Figures A-11 through A-15. It should be noted that computer-aided slope stability analyses are mathematical models of slopes and subsurface materials, and they contain many assumptions. Slope stability analyses and the generated factors of safety should only be used to indicate general slope stability trends. In general, factors of safety below 1.00 indicate a potential failure. However, a slope with a factor of safety less than 1.00 will not necessarily fail but the probability of failure will be greater than in a slope with a higher factor of safety. Conversely, a slope with a factor of safety greater than 1.00 may fail but the probability of stability is higher than that in a slope with a lower factor of safety.

CONCLUSIONS & RECOMMENDATIONS

Based on the results of our investigation, it is our opinion that the proposed residential subdivision is feasible from an engineering geologic and geotechnical perspective. In our opinion, the primary constraints to the project include the potential for shallow landsliding and/or debris flows developing along the steeper portions of the property, consolidation, creep, and/or shallow landsliding of the undocumented fill along the downhill side of Parrott Drive, and the potential for strong to very strong ground shaking during a moderate to large earthquake on the nearby San Andreas fault or one of the other nearby active faults.

In general, the proposed residences will be located in the uphill portion of the lots, adjacent to Parrott Drive. We understand that the residence on Lot 1 may alternatively be shifted downhill and accessed by a shared driveway extending from Lot 2. In our opinion, the proposed building pads are feasible; however, due to the logistics of building a structure over a storm drain culvert, we recommend that the residence building site on Lot 4 be shifted to the north, away from the storm drain culvert.

Based on our investigation, the proposed improvement areas are blanketed by variable amounts of fill and colluvium underlain by sandstone and sheared rock bedrock. In particular, a substantial wedge of fill is located along the downhill side of Parrott Drive. We assume that this fill slope was not placed as a properly engineered fill with keyway, benches and possibly subdrainage. Therefore, in our opinion, this material will be subject to future consolidation, downhill creep, and possible shallow landsliding and should not be relied on for support of the proposed improvements. In our opinion, the proposed residences and associated retaining walls should be supported on drilled pier foundations extending through the fill and colluvium and gaining support in the underlying bedrock.

We briefly reviewed the potential for geologic hazards to impact the site, considering the geologic setting and our observations during our site reconnaissance. The results of our review are presented below:

- ⦿ Landsliding – Based on our investigation, we did not observe any evidence of active landsliding in the immediate area of the proposed residence on Lot 3. However, as noted above, an active landslide is located along the boundary between Lots 1 and 2, approximately 50 feet from the currently proposed residence on Lot 1 and 10 feet from the residence on Lot 2. This feature appears to be directly related to cuts and fills associated with past grading of the access road. Based on our field reconnaissance, this feature also appears to be relatively shallow and does not extend up into the footprint of the building site. Given the location of this feature with respect to the locations of the proposed structures, in our opinion, reactivation of this feature could impact the proposed improvements. Therefore, we recommend mitigating this landslide as discussed in the recommendations section below.

In addition, a relatively shallow debris flow is located in the drainage swale at the lower end of Lot 2. This feature is located more than 200 feet from the proposed building site and appears to be confined to the drainage swale. In our opinion, if this feature were to reactivate it would have little to no impact on the proposed improvements.

The evacuated headscarp of a debris flow is located along the downhill side of the proposed residence on Lot 4. This feature appears to be the result of very steep slopes in combination with granular soil type and heavy precipitation during past rainfall events. In our opinion, it is likely that new debris flows and shallow earth slumps will occur along the drainage ravine; however, given that the proposed building site is located upslope of the drainage ravine, in our opinion, future movement of these features should not have a direct impact on the proposed improvements provided that they are design in accordance with the recommendations of this report. As noted above, we also recommend shifting the building site on Lot 4 to the north and away from the drainage culvert.

In our opinion, given the presence of similar shallow landslide features on the property and steep slope conditions, future movement of these active landslides/debris flows as well as generation of new shallow earth slumps and/or debris flows is likely. In our opinion, future movement of these features should not have a direct impact on the proposed improvements provided that they are designed in accordance with the recommendations of this report.

Based on our investigation, the slopes on the proposed lots generally appear to be underlain by resistant bedrock and it is our opinion that the potential for a deep-seated landslide emanating from these slopes is low. As noted above, a mapped presumably ancient landslide crosses the southwest corner of Lot 4. Based on the

slope stability analyses performed by BAGG, it appears that there is a potential risk of seismic slope instability within the mapped slide areas. However, BAGG indicated that the bedrock strength is higher in areas of the property where there is no evidence of deep-seated slope movement and concluded that development outside of the mapped slide areas is feasible. In our opinion in the unlikely event this landslide feature were to move during a large seismic event, given its proximity from the proposed house site coupled with the reasoning (based on review of past performance of large landslide complexes after large earthquake events such as what occurred after the Loma Prieta Earthquake in the Santa Cruz Mountains) that the feature would likely not fully mobilize but may shift downslope to some degree along its boundaries, in our opinion such anticipated movement would not significantly impact the global stability of the proposed house site on Lot 4.

We note that based on our investigation, it is our opinion that there is a moderate risk for continued erosion and slight retrograde of the active landslide and debris flows on the proposed lots. However, the potential for landsliding significantly impacting the present locations of the proposed building sites is relatively low provided the recommendations in this report are carefully followed and incorporated into the design of the structures. In addition, given the steep slopes across the proposed building sites and the presence of relatively thick surficial colluvial soil, the occurrence of a new shallow landslide in this area cannot be excluded. A new, relatively shallow landslide in the colluvium could be triggered by excessive precipitation and/or strong ground shaking associated with an earthquake. In our opinion, a landslide of this nature should not constitute a significant hazard to the proposed improvements provided that they are designed and constructed in accordance with the recommendations presented in this report. However, there is a potential risk for debris flow activity that could impact property and structures in the lower portions of the site. Evaluation of this potential hazard was beyond the scope of our investigation. However, as discussed in the previous consultants' reports, typical mitigation involves installation of debris impact/deflection walls to impede direct impact on structures.

It should be noted that although our knowledge of the causes and mechanisms of landslides has greatly increased in recent years, it is not yet possible to predict with certainty exactly when and where all landslides will occur. At some time over the span of thousands of years, most hillsides will experience landslide movement as mountains are reduced to plains. Therefore, an unknown level of risk is always present to structures located in hilly terrain. Owners of property located in these areas must be aware of and be willing to accept this risk.

- ❖ **Fault Rupture** – Based on our site reconnaissance and our review of published geologic maps, it is our opinion that no active or potentially active faults cross the subject property. Therefore, in our opinion, the potential for fault rupture to occur at the site is very low.

- ❖ **Ground Shaking** – As noted in the Seismicity section above, moderate to large earthquakes are probable along several active faults in the greater Bay Area. Therefore, strong to violent ground shaking should be expected in the area during the design-life of the proposed improvements. In our opinion, the improvements should be designed in accordance with the current earthquake resistant standards, including the 2013 CBC guidelines and design parameters presented in this report. It should be clearly understood that these guidelines and parameters will not prevent damage to structures; rather they are intended to prevent catastrophic collapse of structures.

- ❖ **Differential Compaction** – During moderate and large earthquakes, soft or loose, natural or fill soils can become densified and settle, often unevenly across a site. In our opinion that there is a moderate potential for differential compaction of the fill material located in the upper portion of Lots 1 through 4. However, if the proposed improvements are constructed in accordance with the recommendations of this report on foundations sufficiently embedded in competent materials below the fill, in our opinion the potential for damage from differential compaction can be significantly reduced.

PRELIMINARY GEOTECHNICAL RECOMMENDATIONS

The geotechnical recommendations provided below are based on highly tentative plans and are for general planning purposes. Please note that our preliminary opinions and conclusions may change once the details of the proposed construction have been developed and may require supplemental investigative work.

Due to the steep slopes and the presence of undocumented fill and colluvial soil, we recommend that the proposed residences be supported on drilled piers extending adequately into bedrock. If basements will be included in the design, the basement floors should be designed as a structural slab supported on piers. The building contractor should take appropriate precautions to shore the proposed basement excavations. The design and construction of any temporary shoring or dewatering is the responsibility of the building contractor.

It is anticipated that retaining walls will be utilized along the driveway and to accommodate grade changes across the building sites. Retaining walls should be supported on drilled piers embedded into bedrock. If desired, grouted tieback anchors may be utilized to help resist active loads on the piers. Although plans are highly tentative, we anticipate that a driveway may be constructed along the uphill side of the active landslide on Lots 1 and 2. In addition, the proposed building sites on Lots 1 and 2 are approximately 50 and 10 feet, respectively, from the landslide feature. To mitigate the potential for reactivation of the active landslide on Lots 1 and 2 to impact the proposed improvements, we recommend that a retaining wall be constructed along the uphill margin of the slide feature. The retaining wall should be installed prior to grading for the driveway and residence improvements to reduce the potential for the grading to trigger a slope failure. As an alternative, the landslide mitigation may include removing portions of the landslide debris and replacing it as a keyed and benched engineered fill supported on the underlying bedrock in addition to constructing retaining walls to stabilize the slope above. We note that the lower portion of the shallow landslide will remain and therefore subject to continued slope movement. Such slope movement will in our opinion not significantly impact the planned improvements (being located uphill) provided the recommendations in this report are carefully followed.

Slabs-on-grade may be used for driveways, patios, walkways, and garage floors; however, it should be anticipated that some degree of differential movement could occur between these slabs and adjacent pier-supported structures. To significantly minimize the movement potential of concrete slabs, the more critical exterior slabs can alternatively be constructed as structural slabs supported on piers. Alternatively, to minimize repair costs associated with heave and/or settlement cracking of exterior concrete slabs-on-grade, we suggest the use of sand-set pavers, which can be constructed with a thinner section of underlayment and relatively low costs associated with re-leveling of heave-related movement. Detailed recommendations are presented in the following sections of this report.

2013 CBC EARTHQUAKE DESIGN PARAMETERS

Site-specific earthquake design parameters have been developed based on the procedures described in Chapter 16, Section 1613 of the 2013 California Building Code (California Building Standards Commission, 2013). These procedures utilize State standardized spectral acceleration values for maximum considered earthquake ground motion taking into account historical seismicity, available paleoseismic data, and activity rates along known fault traces, as well as site-specified soil and bedrock response characteristics. Contour maps of Class B bedrock horizontal spectral acceleration values for the State of California are included as figures in Chapter 16 of the 2013 CBC, representing both short (0.2 seconds) and long (1.0 second) periods of spectral response and taking into account 5 percent of critical damping. The U.S. Geological Survey (2013) has prepared an online seismic design value application tool, based on the 2010 ASCE with a July 2013 CBC errata, for public use, that allows for

site-specific adjustments of these acceleration values for different subsurface conditions, which are defined by site classes. Given representative latitude of 37.539 and longitude of -122.347 in accordance with guidelines presented in the 2013 CBC, the following seismic design parameters will apply for this site:

- Site Class C – Soil Profile Name: Very Dense Soil and Soft Rock (Table 1613.5.2)
- Mapped Spectral Accelerations for 0.2 second Period: $S_S=2.166$ (Site Class B)
- Mapped Spectral Accelerations for a 1-second Period: $S_1=1.216$ (Site Class B)
- Design Spectral Accelerations for 0.2 second Period: $S_{DS}=1.444$ (Site Class C)
- Design Spectral Accelerations for a 1-second Period: $S_{D1}=1.054$ (Site Class C)

FOUNDATIONS

Drilled Piers

Given the anticipated steep slope conditions and presence of existing undocumented fill, we recommend drilled piers for the residences be at least 16 inches in diameter, at least 20 feet in depth from bottom of grade beam or slab elevation, and should be embedded a minimum of 12 feet into the bedrock. Piers for site retaining walls (those walls that are not structurally tied to any structures) should extend at least 8 feet into the bedrock or to a depth equal to the height of the retaining wall plus the thickness of non-supportive soil in the upper portion of the pier column. In addition, if piers are used for structural supported patio slabs, the piers should extend at least 8 feet into bedrock or to a depth equal to the thickness of non-supportive soil overlying the bedrock. Please note, that these are recommended minimum pier dimensions and that other structural criterion, such as the need to resist lateral creep forces, may force the pier design depths to be greater. In general, drilled piers should be spaced no closer than approximately three pier diameters, center-to-center.

Drilled piers should be designed to resist dead plus live loads using an allowable skin friction value of 500 pounds per square foot for the depth of the pier in the bedrock with a one-third increase allowed for transient loads, including wind and seismic forces. Any portion of the piers in the fill, colluvium, or landslide deposits, and any point-bearing resistance should be neglected for support of vertical loads. For piers adjacent steep slopes, supportive material (bedrock) should start a minimum horizontal distance of 10-feet from the daylight of slope. The depth however, may be modified by our representative during construction, especially if very dense bedrock areas are encountered.

To resist lateral creep of near surface soils, we recommend that piers be designed to resist an active soil pressure equal to an equivalent fluid weight of 85 pounds per cubic foot (pcf), acting over 2-pier diameters in the downhill direction over the depth of the piers embedded in the non-supportive soil. The depth of the active loads will vary slightly at individual pier

locations. Based on our subsurface investigation, we anticipate active soil depths up to approximately 11 feet and less than a foot where grading removes the existing surficial colluvium. To avoid over-design and to facilitate pier construction, we suggest that the project structural engineer develop a pier table that provides required pier embedment depth into supportive bedrock based on the depth of overlying non-supportive material from 0 to 14 feet.

The active loads from soil creep and other lateral loads may be resisted by passive earth pressure based upon an equivalent fluid pressure of 425 pounds per cubic foot (pcf), acting on 2 times the projected area for the depth of the pier in the bedrock. Any passive resistance corresponding to the creep zone described above should be neglected.

To create a relatively rigid structure, we recommend that piers for the residences be interconnected with grade beams. Grade beams for the site retaining walls should be provided based on structural requirements. Perimeter grade beams for the residences should extend at least 6 inches below the crawlspace grade or bottom of slab subgrade to reduce the potential for infiltration of surface runoff under the structures.

Pier and grade beam layout and reinforcing should be determined by the project structural engineer based on the preceding design criteria and structural requirements.

If grading for the building pads exposes highly expansive soil, the tops of piers should be prevented from "mushrooming" to minimize the potential for uplift on the piers. This may be accomplished by placing Sonotubes within the upper 2 feet of the pier excavations prior to placement of concrete or by other construction methods. In addition, grade beams embedded in highly expansive soil should be formed over 2-inch thick cardboard void forms, such as manufactured by SureVoid, to minimize the potential for uplift on the grade beams.

Based on our engineering judgment, thirty-year differential foundation movement due to static loads is not expected to exceed approximately $\frac{3}{4}$ -inch across any 20-foot span of the pier-supported residence and garage.

Grouted Tieback Anchors

If desired, grouted tieback anchors may be incorporated into the planned building and site retaining wall foundation design to help resist lateral loads on the new piers. The current design practice considers tieback capacity as developed in friction along a portion of the tieback length embedded into competent bedrock (bonded length). On a preliminary basis, tieback anchors should be designed to resist dead plus live loads using an allowable skin friction value of 850 psf (bond between bedrock and grout) for the bonded length of the

anchor embedded in competent bedrock with a one-third increase allowed for transient loads, including wind and seismic forces. This bond strength should be confirmed in the field during the initial stages of construction with proof and performance load testing.

To maintain good grout retention, the tiebacks should be drilled with an angle of declination of at least roughly 15 degrees from horizontal. The bonded (anchor) length of the tiebacks should be established by the structural engineer based on the recommended allowable bond strength provided above. The unbonded length should be corrosion-protected with a grease-filled tube, a heat-shrinkage sleeve or with other approved methods.

The tiebacks should be proof-tested, performance-tested and creep-tested in accordance with general guidelines of the industry. The drilling and testing of tiebacks should be observed by a representative of Murray Engineers, Inc., to establish that the minimum depths and recommended bond strengths are achieved.

The anchor depths recommended above may require adjustment if differing conditions are encountered during drilling. While we expect that moderate sized drilling equipment can obtain the required depths, the tieback contractor should carefully review the boring logs in our report and should consider the potential for caving of some of the more granular soils encountered at the site.

BASEMENT & SITE RETAINING WALLS

It is anticipated that retaining walls will be used for the new residence basements (if constructed), to stabilize the slope above the active landslide, and to accommodate site grade changes. Basement and site retaining walls should be supported on foundations designed in accordance with the recommendations provided above. Damp proofing or waterproofing of walls should be included in areas where wall moisture would be undesirable, such as where wall finishes could be impacted by concrete moisture. The project architect or a waterproofing consultant should provide detailed recommendations for waterproofing or damp proofing, as necessary.

Lateral Earth Pressures

Retaining walls should be designed to resist lateral earth pressure from the adjoining natural soils, backfill, and any anticipated surcharge loads. Assuming that the backfill behind the wall will be level (e.g., not sloping upward) and that adequate drainage will be incorporated as recommended below, we recommend that unrestrained retaining walls be designed to resist an equivalent fluid pressure of 45 pounds per cubic foot (pcf) plus one-third of any anticipated surcharge loads. Walls restrained from movement at the top should be designed to resist an equivalent fluid pressure of 45 pcf plus a uniform pressure of 8H pounds per

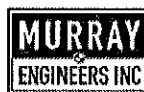

square foot (psf), where H is the height in feet of the retained soil. Restrained walls should also be designed to resist an additional uniform pressure equal to one-half of any surcharge loads applied at the surface.

In accordance with the 2013 CBC, where applicable, retaining walls should also be designed to resist lateral earth pressure from seismic loading, as deemed necessary by the project structural engineer. We recommend that the seismic loading be based on a uniform pressure of 10H pounds per square foot (psf)/foot of wall height, where H is the height in feet of the retained soil. The allowable passive pressures provided for retaining wall foundations may be increased by one-third for short-term seismic forces.

Where backfill behind the wall will be sloping upward from the wall, we recommend that the equivalent fluid pressures given above be increased by 3 pcf for each 4-degree increase in slope inclination. For sloping conditions steeper than 2:1, we should review the proposed design when it is available and provide specific lateral pressure recommendations upon completion of our review.

Retaining Wall Drainage

We recommend that retaining walls include a subsurface drainage system to mitigate the buildup of water pressure from surface water infiltration and other possible sources of water. Retaining wall backdrains should consist of a minimum 4-inch diameter, perforated rigid pipe, Schedule 40 or SDR 35 (or equivalent) with the perforations facing down, resting on a thin layer of crushed rock at the base of the walls. Subdrain pipes should be bedded and backfilled with ½- to ¾-inch clean crushed rock separated from the native soil with a geotextile filter fabric, such as TC Mirafi 140N or equivalent. The crushed rock backfill should extend vertically to within 12 inches of the finished grade and laterally at least 12 inches from the rear face of the wall. The crushed rock should be compacted with a jumping jack or vibratory plate compactor in lifts not exceeding 12 inches in loose thickness. The upper approximate 18 inches of backfill should consist of native soil, which should be compacted in accordance with the Compaction section of this report to mitigate infiltration of surface water into the subdrain systems. The preceding basement drainage recommendations are presented schematically on Figure A-16, Basement Subdrain System Alternative A.

The subdrain pipes should be sloped at a minimum of 1.5 percent and should be connected to rigid, solid (non-perforated) discharge pipes to convey any collected water to a suitable discharge location downslope from walls. The subdrain pipes should be provided with cleanout risers at their up-gradient ends and at most sharp directional changes to facilitate maintenance. All surface drainage pipes, including those connected to downspouts and area drains should be kept completely separate from the retaining wall drainage systems.

As an alternative to crushed rock, Miradrain, Enkadrain, or other geosynthetic drainage panels approved by this office may be used for retaining wall drainage. If used, the drainage panels should extend from a depth of 18 inches below finish grade to the base of the retaining wall. A 2-foot section of crushed rock wrapped in filter fabric should be placed around the drainpipe, as discussed previously. Geosynthetic drainage panels should be installed in strict compliance with manufacturer's recommendations with filter fabric against the crushed rock and soil backfill. The preceding recommendations are presented schematically on Figure A-17, Basement Subdrain System Alternative B.

Backfill

Backfill placed behind site retaining walls should be compacted in accordance with the Compaction specifications given in this report, using light compaction equipment. If heavy compaction equipment is used, the walls should be temporarily braced.

CONCRETE SLABS

Because of the steep slopes, we recommend that the basement floors of the residences (if constructed) and preferably the at-grade garage floors be designed and constructed as structural slabs supported on drilled pier foundations designed in accordance with the previous sections. Slabs-on-grade may be used for the driveway, patios, walkways, and possibly the garage floor; however, it should be anticipated that some degree of differential movement could occur between these slabs and adjacent pier-supported improvements. To significantly minimize the movement potential of concrete slabs, the more critical exterior slabs can alternatively be constructed as structural slabs supported on drilled piers. Alternatively, to minimize repair costs associated with heaving and cracking of exterior concrete slabs-on-grade, we suggest the use of sand-set pavers, which can be constructed with a thinner section of underlayment and relatively low costs associated with re-leveling of heave-related movement. The project structural designer should determine structural slab and slab-on-grade reinforcement based on anticipated use and loading.

Structural Slabs

The basement and preferably at-grade garage structural slabs should be supported on drilled piers designed in accordance with the recommendations for the residence provided above. In addition, the basement slab should be provided with a damp-proofing system that is integral with the basement retaining wall waterproofing or damp-proofing systems. We recommend that the slab be underlain by a minimum of 8 inches of 1/2- to 3/4-inch clean crushed rock underlain by filter fabric. Where expansive materials are exposed at the basement subgrade level, the slab should be underlain by 2-inch thick void forms to mitigate excessive uplift forces from expansive soil and/or bedrock against the bottom of the slab and to serve as a capillary break between the underlying subgrade and the slabs. If void

forms are utilized, the crushed rock section below may be reduced to 6 inches. The subgrade soil beneath the basement slab should be sloped at an inclination of not less than about 1.5 percent to the perimeter trench where the retaining wall drainage pipe will be located. Please refer to the retaining wall drainage section of this report for additional details.

To minimize the potential for cracking and heaving of the more critical exterior slabs, we suggest that these slabs be designed as structural slabs supported on drilled pier foundations designed in accordance with the recommendations above. Where expansive soils are exposed at the subgrade level, a 2-inch thick void form should underlie these slabs to mitigate excessive uplift forces against the bottom of the slab. The void formers may be placed directly on the uniformly graded subgrade soils.

If it is desired to limit slab dampness from soil moisture vapors, we recommend that a heavy-duty impermeable membrane be placed over the void form to limit slab dampness from soil moisture vapors. In particular, we suggest the use of an integrally bonded vapor retarder such as Florprufe™ (Grade Construction Products), which will remain in direct contact with the slab when the cardboard void-former deteriorates. Please refer to the Vapor Retarder Considerations section below for additional information. Please note that these recommendations do not comprise a specification for “waterproofing.” For greater protection against concrete dampness, we recommend that a waterproofing consultant be retained.

Slabs-on-Grade

We anticipate that concrete slabs-on-grade will be used for driveways, garage floors, and exterior patios and walkways. The driveway and garage slabs should be underlain by a minimum of 12 inches of Class 2 aggregate baserock and slabs for exterior patios and walkways may be underlain by 8 inches of Class 2 aggregate baserock. We note that the placement of the above thickness of baserock beneath proposed slabs will in our opinion substantially mitigate but not completely eliminate the potential for differential performance of these slabs. In general, slabs-on-grade should be designed as “free-floating” slabs, structurally isolated from adjacent foundations. If the garage slab will be structurally tied to the foundation, we recommend increasing the aggregate baserock section to 18 inches.

Slab-on-grade sections adjacent the basement walls should be designed to span the area underlain by the planned basement retaining wall back-fill (approximately 10-feet) to mitigate the concerns for back-fill settlement. In addition, where existing fill is present within areas of new hardscape, the fill should generally be removed and replaced as engineered fill. Prior to the placement of the baserock, the subgrade soils should be scarified and moisture

conditioned, as necessary, to a depth of approximately 6 inches and re-compacted in accordance with the Compaction section of this report.

To reduce the potential for slab surface moisture, we recommend that interior slabs, including the garage slabs, be underlain by a vapor retarder consisting of a highly durable membrane not less than 10 mils thick (such as Stego Wrap Vapor Retarder by Stego Industries, LLC or equivalent). The vapor retarder should be underlain by a capillary break consisting of 4 inches of ½- to ¾-inch crushed rock. The capillary break may be considered the equivalent thickness as the upper 4 inches of Class 2 aggregate baserock recommended above. Please also refer to the Vapor Retarder Considerations section below for additional information. Please note that these recommendations do not comprise a specification for "waterproofing." For greater protection against concrete dampness, especially at interior living spaces, we recommend that consideration be given to utilizing a waterproof membrane in place of the vapor retarder. A qualified waterproofing consultant should provide specific waterproofing products and details.

Slabs-on-grade should be provided with control joints at spacing of not more than about 10 feet. The project structural designer should determine slab reinforcement based on anticipated use and loading.

Vapor Retarder Considerations

Based on our understanding, two opposing schools of thought currently prevail concerning protection of the vapor retarder during construction. Some believe that 2 inches of sand should be placed above the vapor retarder to protect it from damage during construction and also to provide a small reservoir of moisture (when slightly wetted just prior to concrete placement) to benefit the concrete curing process. Still others believe that protection of the vapor retarder and/or curing of concrete are not as critical design considerations when compared to the possibility of entrapment of moisture in the sand above the vapor retarder and below the slab. The presence of moisture in the sand could lead to post-construction absorption of the trapped moisture through the slab and result in mold or mildew forming at the upper surface of the slab.

We understand that recent trends are to use a highly durable vapor retarder membrane (at least 10 mils thick) without the protective sand covering for interior slabs surfaced with floor coverings including, but not limited to, carpet, wood, or glued tiles and linoleum. However, it is also noted that several special considerations are required to reduce the potential for concrete edge curling if sand will not be used, including slightly higher placement of reinforcement steel and a water-cement ratio not exceeding 0.5 (Holland and Walker, 1998). We recommend that you consult with other members of your design team, such as your

structural engineer, architect, and waterproofing consultant for further guidance on this matter.

FLEXIBLE PAVEMENTS

It is anticipated that flexible hardscape may be utilized as part of the proposed construction. Specifically, we anticipate that the driveway may be surfaced with either asphaltic concrete or pavers and that pavers or flagstone may be used for patios and walkways. We note that due to the fill that likely underlies portions of the proposed hardscape, there exists a moderate potential for differential performance of new hardscape. One advantage of using sand-set pavers for exterior hardscape areas at this site would be that the pavers could accommodate slight differential movement and could be relatively easily repaired if differential movement occurred.

Asphalt Driveway

We recommend that the asphalt driveway surface(s), if utilized, be at least 2.5 inches thick and that it be underlain by at least 12 inches of Class 2 aggregate baserock (R-value 78). If highly expansive soil or soft subgrade conditions are encountered at subgrade elevation along the driveway, it may be advisable to increase the thickness of the select granular fill. Prior to placement of the select granular fill, the subgrade soils should be scarified to a depth of approximately 6 inches, moisture conditioned (as necessary), and re-compacted in accordance with the Compaction section of this report.

Sand-Set Pavers

If sand-set stone pavers are planned for the driveway(s), because of traffic loads, we recommend that pavers be underlain by at least 12 inches of Class 2 aggregate baserock. If sand-set pavers or flagstone are planned for patios and walkways, we recommend that the pavers or flagstone be underlain by at least 6 inches of Class 2 aggregate baserock. Prior to placement of baserock, the surficial soil should be scarified to a depth of approximately 6 inches and re-compacted in accordance with the Compaction section of this report.

EARTHWORK

At the time this report was prepared, the scope of the proposed grading had not been determined. However, we anticipate that a moderate to significant amount of earthwork will be required to develop the 4-lot subdivision, including the possibly re-grading of portions of the active landslide feature mapped on Lots 1 & 2. We recommend that proposed earthwork be performed in general accordance with the following recommendations.

Clearing & Site Preparation

Initially, the proposed improvement should be adequately stripped to remove surface vegetation and organic-laden topsoil. The stripped material should not be used as engineered fill; however, it may be stockpiled and used for landscaping purposes. Excavations that extend below finished grade resulting from the removal of underground obstructions, such as utilities and root balls, should be backfilled with engineered fill, compacted in accordance with the recommendations presented below.

Material for Fill

All on-site soils below the stripped layer having an organic content of less than 3 percent organic material by volume (ASTM D 2974) should be suitable for use as engineered fill. In general, fill material should not contain rocks or pieces larger than 6 inches in greatest dimension, and should contain no more than 15 percent larger than 2.5 inches. Any required imported fill should have a plasticity index of less than approximately 15 percent and should be sufficiently cohesive to maintain a temporary vertical excavation. Any proposed fill for import should be approved by Murray Engineers, Inc. prior to importing to the site. Our approval process may require index testing to evaluate the plasticity of the soil; therefore, it is important that we receive samples of any proposed import material at least 3 days prior to planned importing. Class 2 aggregate baserock should meet the specifications outlined in the Caltrans Standard Specifications, latest edition.

Keying & Benching

Unretained fill placed on slopes that are flatter than 5:1 should be supported on level benches bearing in supportive materials, as determined by this office in the field during construction. Unretained fill placed on slopes that are steeper than 5:1 should be keyed and benched into supportive material to provide a firm, stable surface on which to support the fill. Keying and benching should be performed in general accordance with the attached Figure A-18, Schematic Fill Slope Detail.

Prior to fill placement on slopes steeper than 5:1, a construction keyway should be excavated at the toe of the fill. The keyway should be a minimum of 8 feet wide or a width equal to half the height of the fill slope, whichever is greater. The keyway should be excavated a minimum of 2 feet into competent support material, as measured on the downhill side of the excavation. The depth to supportive material should be determined by this office in the field during construction. The base of the keyway excavation should have a nominal slope of approximately 2 percent dipping toward the back (uphill side) of the key. Subsequent construction benches should be excavated to remove any non-supportive surficial soil and should also have a nominal slope of approximately 2 percent dipping in the uphill direction. Our representative should observe the completed keyway and bench excavations to confirm

that they are founded in materials with sufficient supporting capacity.

Fill Subdrainage

Fills exceeding approximately 5 feet in depth (or within areas of the active landslide on Lots 1 & 2 to be re-graded) should be provided with subdrainage. Subdrains should consist of a 4-inch diameter, rigid, heavy-duty, perforated pipe (Schedule 40, SDR 35 or equivalent) embedded in ½- to ¾-inch clean crushed rock placed along the upslope side of keyways and benches for the full height of the keyway or bench cut. The crushed rock should be separated from the fill and the native material by a geotextile filter fabric. The perforated subdrain pipe should be placed with the perforations down on a 2- to 3-inch bed of drain rock. Subdrain pipes should be provided with clean-out risers at their up-gradient ends and at all sharp changes in direction. Subdrain systems should be provided with a minimum 1 percent gradient and should discharge at an appropriate downhill location, as discussed in the Site Drainage section below.

Compaction

The scarified surface soils and all structural fill should be compacted in uniform lifts, no thicker than approximately 8-inches in un-compacted thickness, conditioned to the appropriate moisture content, and compacted to the specifications listed in Table 1 below. The relative compaction and moisture content specified in Table 1 is relative to ASTM D 1557, latest edition. Compacted lifts should be firm and non-yielding under the weight of compaction equipment prior to the placement of successive lifts.

Table 1. Compaction Specifications

Fill Element	Relative Compaction*	Moisture Content*
General fill for raising of site grades, driveway, patio areas and retaining wall backfill (for fills up to 4 feet thick)	90 percent	Near optimum
For fills greater than 4 feet thick	93 percent	Near optimum
Upper 12 inches of potentially expansive subgrade beneath slabs-on-grade (PI>20)	88 to 90 percent	~3% Over optimum or greater
Upper 6 inches of non-expansive subgrade beneath slabs-on-grade (PI<20)	90 percent	Near optimum
Aggregate baserock under hardscapes	95 percent	Near optimum
½- to ¾-inch Crushed Rock - Compact with at least 3 passes of a vibratory plate with lift-thickness ≤ 12 inches.	see note at left	Not critical
Backfill of utility trenches using on-site soils	90 percent	~2% Over optimum
Backfill of utility trenches using imported sand	95 percent	Near optimum

*Relative to ASTM D 1557, latest edition.

Final Slopes

In general, any proposed cut slopes in the surficial soil and any proposed fill slopes should have gradients no steeper than 2:1 (horizontal to vertical). In general, all new fill slopes should be over-filled and then cut back to proposed final slope gradients. All graded surfaces or areas disturbed by construction should be revegetated prior to the onset of the rainy season following construction to mitigate excessive soil erosion. If vegetation is not established, other erosion control provision should be employed. Ground cover, once established should be properly maintained to provide long-term erosion control.

Temporary Slopes, Trench Excavations & Shoring

The contractor should be responsible for all temporary slopes and trenches excavated at the site and design and construction of any required shoring. Shoring and bracing should be provided in accordance with all applicable local, state, and federal safety regulations, including the current OSHA excavation and trench safety standards. Because of the potential for variable soil conditions, field modifications of temporary cut slopes may be required. Unstable materials encountered on the slopes during the excavation should be trimmed off, even if this requires cutting the slope back at flatter inclinations.

SITE DRAINAGE

In our opinion, careful design of the site surface drainage system is critical to the successful development of hillside properties. In our opinion, a qualified civil engineer should develop site drainage plans. In general, we recommend that structures be provided with roof gutters and downspouts and that these drainage devices be connected to buried pipes to convey collected water to suitable discharge locations. Because of the steep slopes, we strongly suggest discharging any collected water into the existing storm drain system. If necessary, storm water may be discharged on the property at an appropriate downslope location; however, there is a potential for erosion and shallow landsliding to impact the area below. To minimize erosion, we recommend that all collected water be discharged onto adequately designed energy dissipaters.

Surface runoff should be prevented from flowing over the top of any artificial slope. The ground surface at the top of the slope should be graded to slope away from the slope or a berm or lined drainage ditch should be provided at the top of the slope. In addition, retaining walls at the bases of descending slopes should be provided with lined drainage swales along their uphill side to collect surface water from above. All collected water should be conveyed away from the development area by buried closed conduit and discharged into the existing storm drain system or at an appropriate downslope location.



We recommend that annual maintenance of the surface drainage systems be performed. This maintenance should include inspection and testing to make sure that roof gutters and downspouts are in good working order and do not leak; inspection and flushing of area drains to make sure that they are free of debris and are in good working order; and inspection of surface drainage outfall locations to verify that introduced water flows freely through the discharge pipes and that no excessive erosion has occurred. If erosion is detected, this office should be contacted to evaluate its extent and to provide mitigation.

REQUIRED FUTURE SERVICES

PLAN REVIEW

To better note conformance of the final design documents with the recommendations contained in this report, and to better comply with the building department's requirements, Murray Engineers, Inc. must review the completed project plans prior to construction. The plans should be made available for our review as soon as possible after completion so that we can better assist in keeping your project schedule on track. We recommend that the following project-specific note be added to the architectural, structural, and civil plans:

- All earthwork and site drainage, including site grading, pier and tieback excavations, tieback testing, placement and compaction of engineered fill, preparation of subgrade and underlayment beneath any slabs and/or the driveway, retaining wall backfill, and final surface drainage installation should be performed in accordance with the geotechnical report prepared by Murray Engineers, Inc., dated February 10, 2014. Murray Engineers, Inc. should be provided at least 48 hours advance notification of any earthwork operations and should be present to observe and test, as necessary, the earthwork, foundation, and drainage installation phases of the project.

CONSTRUCTION OBSERVATION SERVICES

Murray Engineers, Inc. should observe and test (as necessary) the earthwork and foundation phases of construction in order to a) confirm that subsurface conditions exposed during construction are substantially the same as those interpolated from our limited subsurface exploration, on which the analysis and design were based; b) observe compliance with the geotechnical design concepts, specifications and recommendations; and c) allow design changes in the event that subsurface conditions differ from those anticipated. The recommendations in this report are based on limited subsurface information. The nature and extent of variation across the site may not become evident until construction. If variations are then exposed, it will be necessary to re-evaluate our recommendations.



LIMITATIONS

This report has been prepared for the sole use of Nick Zmay specifically to evaluate the engineering geologic feasibility of the proposed subdivision and future site development and for developing geotechnical design criteria relating to design and construction of the proposed residences and associated improvements on the property at 1551 Crystal Springs Road in San Mateo County, California. The opinions presented in this report are based upon review of prior reports, information obtained from borings at widely separated locations, site reconnaissance, review of field data made available to us, and upon local experience and engineering judgment. Our conclusions and recommendations have been formulated in accordance with generally accepted geotechnical engineering practices that exist in the San Francisco Bay Area at the time this report was prepared. Further, our recommendations are based on the assumption that soil and geologic conditions at or between borings do not deviate substantially from those encountered. It should be clearly understood that geotechnical conditions may become apparent during construction that were not apparent at the time of our investigation. No warranty, either expressed or implied, is made or should be inferred. We are not responsible for data provided by others.

The recommendations provided in this report are based on the assumption that we will be retained to provide the Future Services described above in order to evaluate compliance with our recommendations. If we are not retained for these services, Murray Engineers, Inc. cannot assume any responsibility for any potential claims that may arise during or after construction as a result of misuse or misinterpretation of Murray Engineers, Inc.' report by others. Furthermore, if another geotechnical consultant is retained for follow-up service to this report, Murray Engineers, Inc. will at that time cease to be the Engineer-of-Record.

The opinions presented in this report are valid as of the present date for the property evaluated. Changes in the condition of a property can occur with the passage of time, whether due to natural processes or the works of man, on this or adjacent properties. In addition, changes in applicable standards of practice can occur, whether from legislation or the broadening of knowledge. Accordingly, the opinions presented in this report may be invalidated, wholly or partially, by changes outside of our control. Therefore, this report is subject to review and should not be relied upon after a period of three years, nor should it be used, or is it applicable, for any property other than that evaluated.



TEXT REFERENCES

2007 Working Group on California Earthquake Probabilities, 2008, The Uniform California Earthquake Rupture Forecast, Version 2 (UCERF 2); U.S. Geological Survey Open-File Report 2007-1437; California Geological Survey Special Report 203214; Southern California Earthquake Center Contribution #1138.

ASTM International, 2012, Annual Book of ASTM Standards, 2012, Section Four, Construction, Volume 04.08, Soil and Rock (I): D420-D5876: ASTM International, West Conshohocken, PA, 1809 p.

Bay Area Geotechnical Group, 2007, Draft, Geologic and Geotechnical Report, Proposed Residential Subdivision, Beeson Property, 1551 Crystal Springs Road, Hillsborough, California; unpublished consultant's report, dated December 20, 2007.

Blake, T.F., R.A. Hollingsworth, and J.P. Stewart (editors), 2002, Recommended Procedures for Implementation of DMG Special Publication 117 Guidelines for Analysis and Mitigation of Landslide Hazards in California; Southern California Earthquake Center, Los Angeles, 110 p. plus Appendix.

Brabb, E.E., and Pampeyan, E.H. 1972, Preliminary map of landslide deposits in San Mateo County, California; U.S. Geological Survey Miscellaneous Field Studies Map MF-344, map scale 1:62,500.

California Building Standards Commission, 2013, 2013 California Building Code, California Code of Regulations, Title 24, Part 2, Volume 2 of 2; California Building Standards Commission, Sacramento, CA.

California Geological Survey, 2006, Seismic Hazard Zone Report for the Palo Alto 7.5-Minute Quadrangle, San Mateo and Santa Clara Counties, California, California Department of Conservation, California Geological Survey, Seismic Hazard Zone Report 111.

California Geological Survey, 2008, Guidelines for Evaluating and Mitigating Seismic Hazards in California, California Geological Survey Special Publication 117A.

Holland, Jerry A., and Wayne Walker, 1998, Controlling Curling and Cracking in Floors to Receive Coverings, Publication #C980603: The Aberdeen Group, 2 p.

Leighton and Associates, 1976, San Mateo County Geotechnical Hazard Synthesis Maps, unpublished consultant's maps.

Leyendecker, E.V. Arthur Frankel, Kenneth Rukstales, Eric Martinez, Nicolas Luco, Jeremy Fee, Ned Field, Nitin Gupta, Vipin Gupta, 2011, Ground Motion Parameter Calculator, v. 5.1.0 - 2/10/2011.

Pampeyan, E.H., 1994, Geologic Map of the Montara Mountain and San Mateo 7-1/2' Quadrangles, San Mateo County, California, U.S. Geological Survey, Miscellaneous Investigation Series Map I-2390.

TEXT REFERENCES (Continued)

Site Characteristics, Inc., 1983, Zmay Property, Geotechnical Investigation, unpublished consultant's report, dated July 1983.

U.S. Geological Survey, 2008, Earthquake Hazards Program – U.S. Seismic Hazard 2008 Web Site (accessed on January 30, 2014), <http://earthquake.usgs.gov/hazards/apps/map>>

William Cotton and Associates, 1984, Supplemental Geotechnical Analysis, Lands of Zmay, unpublished consultant's report, dated April 20, 1984.

AERIAL PHOTOGRAPH REFERENCES

U.S. Geological Survey, 1943, Serial Nos. DDB-2B-112 and 113, black and white, 1:20,000, October 11, 1943.

U.S. Geological Survey, 1968, Serial Nos. GS-VBZJ, 1-213 and 214, black and white, 1:30,000, April 18, 1968.

U.S. Geological Survey, 1974, Serial Nos. 9-17 and 18, color, 1:20,000, June 25, 1974.



APPENDIX C

LABORATORY TESTS

Samples from the subsurface exploration were selected for tests to establish the physical and engineering properties of the soils. The tests performed are briefly described below.

Natural moisture content was determined on most samples and dry density on select samples recovered from the borings. The samples were initially trimmed to obtain volume and wet weight measurements and subsequently dried in accordance with ASTM D2216. After drying, the weight of each sample was obtained to determine the moisture content and dry density representative of field conditions and time the samples were collected. The results are presented on the boring logs at the appropriate sample depths.

The Atterberg Limits were determined on two samples in accordance with ASTM D 4318. The Atterberg limits are the moisture content within which the soil is workable or plastic. The results of this test are presented in Figure C-1 and on the boring logs, at the appropriate sample depths.

Direct shear strength testing was performed by Cooper Testing Laboratory on one sample in accordance with ASTM D3080m. This test measures the angle of internal friction (ϕ) and cohesion (C) of the soil. The results of this test are presented as Figure C-2.

APPENDIX D

BAY AREA GEOTECHNICAL GROUP (BAGG) BORING LOGS





County of San Mateo - Planning and Building Department

ATTACHMENT L

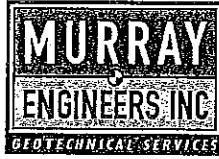

Report
Drainage

June 3, 2015
Project No. 1847-1L4

Nick Zmay
1551 Crystal Springs Road
Hillsborough, California 94010

RE: GEOTECHNICAL PLAN REVIEW,
ZMAY 4 LOT SUBDIVISION,
1551 CRYSTAL SPRINGS ROAD,
SAN MATEO COUNTY, CALIFORNIA

Dear Mr. Zmay:

As requested, we have reviewed the geotechnical aspects of civil plans 3949-TM (sheets 1 and 2), Vesting Tentative Parcel Map, dated May 29, 2015, and prepared by MacLeod & Associates, to assess conformance with the recommendations presented in our engineering geologic and geotechnical report for the four lot subdivision, dated February 10, 2014.

The referenced plans specifically address drainage for the proposed four-lot residential subdivision. The plans include detention systems and dissipaters for each of the four proposed lots.

Based on our review, in our opinion the reference drainage plans have been prepared in substantial accordance with our recommendations and generally accepted geotechnical engineering practices at this time and location. Our plan review services have been performed in accordance with geotechnical engineering principles and practices generally accepted at this time and location. We make no warranty, expressed or implied.

Sincerely,

MURRAY ENGINEERS, INC.

Kaysea A. Porter, P.G. 9269
Project Geologist

Copies: Addressee (3)
MacLeod and Associates (1)
Attn: Mr. Daniel MacLeod, P.E.

John A. Stillman, G.E., C.E.G. 1868
Principal Geotechnical Engineer



RECEIVED

JUN 11 2015

San Mateo County
Planning Division

LN2014-00410

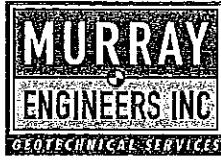

May 28, 2015
Project No. 1847-1L3

Nick Zmay
1551 Crystal Springs Road
Hillsborough, California 94010

RE: GEOTECHNICAL PLAN REVIEW,
LANDSLIDE REPAIR,
ZMAY 4 LOT SUBDIVISION,
1551 CRYSTAL SPRINGS ROAD,
SAN MATEO COUNTY, CALIFORNIA

Dear Mr. Zmay:

As requested, we have reviewed the geotechnical aspects of civil plan C-1, Grading and Drainage Plan for Slide Repair (dated May 18, 2015, prepared by MacLeod & Associates) to assess conformance with the recommendations presented in our engineering geologic and geotechnical report for the four lot subdivision, dated February 10, 2014.

The initial phase of the project will include the repair of an active landslide feature located predominantly within Parcel 2 of the referenced subdivision. Landslide repair activities will include the excavation, regrading, and recompaction of the displaced slide mass. The existing landslide will be replaced with an engineered fill slope, designed with a keyway and benches gaining support in the underlying competent bedrock material. Additional improvements in the immediate vicinity of the landslide will include improved subsurface and surface drainage controls.

Based on our review, in our opinion the landslide repair plan has been prepared in substantial accordance with our recommendations and generally accepted geotechnical engineering practices at this time and location. Our plan review services have been performed in accordance with geotechnical engineering principles and practices generally accepted at this time and location. We make no warranty, expressed or implied.

Sincerely,

MURRAY ENGINEERS, INC.

Kaysea A. Porter, P.G. 9269
Project Geologist

Copies: Addressee (3)
MacLeod and Associates (1)
Attn: Mr. Daniel MacLeod, P.E.

John A. Stillman, G.E., C.E.G. 1868
Principal Geotechnical Engineer



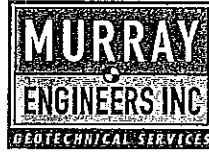

April 15, 2015
Project No. 1847-1L2

Nick Zmay
1551 Crystal Springs Road
Hillsborough, California 94010

**RE: SUPPLEMENTAL EVALUATION &
RESPONSE TO REVIEW COMMENTS,
ZMAY PROPERTY,
1551 CRYSTAL SPRINGS ROAD,
SAN MATEO COUNTY, CALIFORNIA**

Dear Mr. Zmay:

As requested, we have prepared this letter in response to the County of San Mateo's geotechnical review sheet dated December 4, 2014. We have previously conducted an engineering geologic and geotechnical investigation for the development of a four-lot residential subdivision (each containing 2 acres) on the property located at 1551 Crystal Springs Road in an unincorporated area of San Mateo County, near Hillsborough. Our original report was dated February 10, 2014, and summarized the results of our investigation and presented geotechnical design recommendations for the proposed residential subdivision. We prepared a supplemental letter regarding the updated subdivision building envelopes, dated August 26, 2014. In the review sheet, the County presented two review comments. Comment No. 1 requests a supplemental geologic and geotechnical investigation addressing the five sub-comments contained within Comment No. 1. As a part of their comments, they have requested we perform a limited evaluation of the remaining 48 acres of the property. The results of our additional evaluations are presented below, followed by our responses to the County comments. Our responses to the review comments are presented in the same order in which they appear on the geotechnical review sheet.

As described in detail below, based on our previous investigation and the results of our supplemental evaluation, it is our opinion that the proposed four-lot residential subdivision is feasible from an engineering geologic and geotechnical perspective, provided that the recommendations contained in our report are incorporated into the design of the project.

PROJECT DISCUSSION

Geologic Review

The entire approximate 60 acre property is located on a west-facing hillside in the foothills along the northeast side of the Santa Cruz Mountains, a northwest-trending range within the California Coast Ranges geomorphic province. The local topography is dominated by a series of west-trending spur ridges and intervening seasonal drainage swales. Crystal Springs Road extends along the western property boundary at the base of the hillside and converges with Polhemus Road near the southern corner of the property. San Mateo Creek and Polhemus Creek run parallel to Crystal Springs Road and Polhemus Road, respectively. Elevations across the site range from approximately 500 feet along Parrott Drive in the eastern portion of the site down to approximately 140 feet above mean sea level at the base



of the hillside in the northwest corner of the site (see Figure A-1 of Murray Engineers Inc. (MEI's) 2014 report).

According to the Geologic Map of the Montara Mountain and San Mateo 7-1/2' Quadrangles (Pampeyan, 1994), the site is located in an area underlain by Cretaceous and Jurassic age (approximately 65 to 200 million years old) sheared rock of the Franciscan Complex (fsr). The sheared rock generally consists of soft, light- to dark-gray, sheared shale, siltstone, and greywacke sandstone containing various-size tectonic inclusions of Franciscan rock types. According to the geologic map, the lower portion of the slope in the northwest corner of the property is blanketed by Quaternary slope wash, ravine fill, and colluvium deposits (Qsr). These deposits generally consist of unconsolidated to moderately consolidated sand, silt, clay, and rock fragments accumulated by slow downslope movement of weathered rock debris and soil. A copy of the relevant portion of the geologic map is presented on Figure A-3, Vicinity Geologic Map, of MEI's 2014 report.

According to the geologic map, the Geotechnical Hazard Synthesis Map for San Mateo County (Leighton and Associates, 1976), and the Preliminary Map of Landslide Deposits in San Mateo County (Brabb & Pampeyan, 1972), three relatively large landslides are mapped in the central portion of the property. According to the geologic map, the largest feature measures approximately 900 feet in length and 600 feet in width. The upper margin of this feature is located approximately 350 feet to the west (downhill) of Parrott Drive and extends down to Crystal Springs Road. The second mapped landslide is approximately 700 feet long and 500 feet wide and is located immediately south of the first landslide. In addition, smaller landslide features are mapped in the southern portion of the lot and at the northeast corner just off the property. The relevant portions of these maps are included as Figure A-4, San Mateo County Landslide Map and Figure A-5, San Mateo County Geotechnical Hazard Synthesis Map, of MEI's 2014 report.

Previous Relevant Geologic & Geotechnical Investigations

A full discussion of prior geologic and geotechnical investigations was provided in Murray Engineers Inc. (MEI's) 2014 engineering geologic and geotechnical report. However, because the report focused on the subdivision of 8 acres in the upper northeast portion of the property, portions of previous investigations were not discussed in the report. Therefore, we will summarize the relevant information contained in prior reports as it pertains to the County's review comments, listed below; specifically, with respect to the property as a whole and not solely focused on the northeastern portion proposed to be subdivided. For additional information not discussed below, please refer to MEI's 2014 report.

Site Characteristics, Inc. (SCI) conducted a geotechnical investigation on the property, dated July 1983, to address three proposed single family residences along Crystal Springs Road in the northwest lower portion of the property. Subsequently, William Cotton and Associates (WCA) performed a supplemental geotechnical analysis and presented the results in a report dated April 20, 1984. Based on site reconnaissance, subsurface investigations, and slope stability analyses, both consultants indicated that although there were several shallow landslide and slump features on the property, there was no evidence of recent slope instability or of debris flows on the property.



In 2007, Bay Area Geotechnical Group (BAGG) performed a geotechnical and engineering geologic investigation for a proposed 20-lot residential subdivision of the subject property. The results of the investigation were presented in a report dated December 20, 2007. As part of the investigation, BAGG excavated six relatively deep borings within the landslide areas and nine additional borings on the remaining portions of the property, and performed laboratory testing on samples, including triaxial shear and direct shear testing. The locations of these borings are shown on Figure 1. The results of BAGG's slope stability analyses are discussed in MET's 2014 report.

In general, BAGG's borings encountered approximately 5 feet of colluvial soil underlain by bedrock associated with the Franciscan Complex. However, Borings B-2 and B-3, located in the northern portion of the property, encountered approximately 17.5 and 12 feet of colluvial soil, respectively, and Borings B-7 and B-8, located in the southern portion of the property, encountered approximately 14.5 and 12 feet of colluvial soil, respectively. According to BAGG, the colluvial soil consists of stiff to very stiff, low to medium plasticity, lean clay, sandy clay, gravelly clay, and silty gravel. The sixteen borings advanced by BAGG all encountered bedrock at depths of approximately 2 to 17.5 feet, consisting of Franciscan materials with varying degrees of weathering and shearing in a clayey matrix. Based on the subsurface investigation, BAGG formed the opinion that although numerous landslide and slump features were found on the property, site development was feasible outside the mapped slide areas.

Aerial Photography Review

Four sets of historical aerial photographs taken between 1943 and 1974 were reviewed at the U.S. Geologic Survey's library in Menlo Park to aid in evaluating the presence of geomorphic features that may be suggestive of landsliding on the entire 60 acre property. The site is readily identifiable in all of the photographs, based on the topography and the location of Parrott Drive, Crystal Springs Road, and Polhemus Road. Other than the development of the neighboring residential properties, there is very little change in the vicinity of the property during the period covered by the photographs. In the 1943 and 1946 photographs, the streets are present but there is no other development in the vicinity of the property. By the time of the 1968 photographs, most of the homes along Parrott Drive are complete and the building pad on the property immediately northeast of the property appears to be graded. In addition, it appears that improvements were made to Parrott Drive and that additional fill was placed along the downhill side of the roadway. The residences that currently exist along Parrott Drive are present by the time of the 1974 photographs.

In the 1943 and 1946 photographs, two large landslides are present in the central portion of the property, similar to mapping by Pampeyan. The landslides are characterized by broad arcuate topography extending from the downhill side of Parrott Drive down to Crystal Springs Road. The ground surface within the limits of the landslides is generally hummocky with irregular medium to dense vegetation. A small debris flow appears to be located within the limits of the northern landslide. In addition, a debris flow (No. 24-see attached site plan) is located uphill of the southern landslide and drops into the upper portion of the landslide feature. The landslide masses are confined by drainage swales extending down the margins of the features to Crystal Springs Road. In addition, a large debris flow-type landslide complex, also mapped by Pampeyan, is located in the southern portion of the property. There are no signs of quarrying near the mapped quarry in either set of photographs.

It appears that sometime between 1946 and 1968, grading activities were conducted near the southeast property corner in the vicinity of Bel Air Road, Linden Lane, and Enchanted Way, presumably associated with the development of properties in this area. The 1968 photographs show a series of graded terraces, with residences built above, that appear to be relatively cleared of vegetation. The 1974 photographs show the same configuration of what appears to be artificial fill terraces constructed below the residences; however, the ground surface appears to be more vegetated and the terracing is less obvious. Although there is no conclusive evidence to suggest that this grading was conducted as part of a landslide repair, the grading appears to be coincident with the neighborhood located near the southeast property corner and is likely a result of neighborhood development.

In the 1968 photographs, an access road is present near the northeastern property corner. This road enters the subject property from Parrott Drive, extends across the uphill portion (roughly parallel to Parrott Drive) and to the graded pad on the adjacent northern property. It appears that sometime between 1968 and 1974, a small landslide occurred along the downhill side of this access road. A headscarp is present along the uphill margin of this arcuate feature in the 1974 photographs. No evidence of landsliding was observed immediately east of this feature, however, there is a tonal variation in the vegetation and the topography has a very subdued arcuate shape, suggesting that this area may be prone to shallow sliding.

In the 1968 and 1974 photographs, the quarry appears to be active or recently active, evidenced by a bare hillside with little to no vegetation. The mapped landslide immediately north of the quarry (on the eastern side of Crystal Springs Road) appears to have activated sometime between 1946 and 1968, possibly as a result of quarrying activities or due the generation of over-steepened road cuts in this area. A headscarp is present along the uphill margin of this arcuate feature in the 1968 and 1974 photographs and the ground surface within the limits of the landslide is generally hummocky.

The drainage swales located across the property are densely vegetated in the photographs. Any conclusive evidence suggestive of landsliding or debris flows is obscured along these channels.

Supplemental Geologic Mapping

As part of the supplemental evaluation, our project geologist and principal geotechnical engineer conducted additional limited geologic mapping on the property on March 2, 2015. The results of this supplemental geologic mapping and site reconnaissance are included on the Site Plan and Engineering Geologic Map (Figure 1). Due to the scale of the attached site plan and the large area encompassed by the property, we have identified the more significant landslide features on Figure 1 but note that there may be additional shallow features on the property that are not depicted on the map. A brief discussion of the prominent mapped features is included in MEI's 2014 report and the general locations of these features are shown on Figure 1. More detailed discussions of the property are presented in MEI's 2014 report.

As previously discussed, the site topography is dominated by a series of westerly-trending spur ridges and intervening drainage swales. The natural ground surface across the property

is generally steep with gradients varying from 2:1 to 3:1 (horizontal to vertical) and moderately sloping across portions of the mapped landslides with gradients ranging from approximately 4:1 to 5:1. Steeper than 2:1 slopes are present, however, particularly along steep ravines associated with the seasonal drainage swales and pre-existing road and quarry cuts.

Below is a discussion of the landslide features mapped on Figure 1, moving north to south across the property. For ease of reference, these features discussed below are also numbered on Figure 1.

An active relatively shallow landslide (1) is located near the northeastern property corner within the proposed Lot 2 of the referenced 4-lot subdivision. Based on our review of aerial photographs, our site reconnaissance, and as previously discussed in our referenced subdivision report, it appears that a 40-foot wide failure appears to have occurred along the downhill side of the graded access road, widening the area of the active landslide from what was previously mapped. This active landslide was absent from the 1943 and 1968 aerial photographs, but appeared in the latest photographs following construction of the graded access road (as discussed above). In our opinion, grading associated with construction of this road is likely the main probable cause of the landslide. It appears that this active landslide is less than 10 feet thick in depth.

An additional active, relatively shallow landslide (2) is located near the northwest property corner, along the road cut above Crystal Springs Road. Based on our site reconnaissance, this feature appears to be approximately 200 feet wide and approximately 100 feet in length. The slide mass is characterized by generally hummocky topography. In our opinion, grading associated with construction of Crystal Springs Road is likely the main probable cause for activation of the landslide. It appears that this active landslide is relatively shallow, likely less than 10 feet thick in depth. Two similar, smaller features (3 and 4) are located further south along Crystal Springs Road with slide mass dimensions of approximately 75 feet wide and approximately 25 feet in length and approximately 50 feet wide and approximately 60 feet in length, respectively.

A debris flow type feature (5) was initially mapped by SCI along the drainage swale below the active landslide in the northeastern property corner, below the proposed lots 2 and 3; however, this feature was questioned by WCA. This feature was subsequently mapped again by BAGG. Based on our site reconnaissance and aerial photograph review, a significant amount of erosion has occurred at the head of this feature; however, very dense vegetation obscures the topography. Additional small shallow landslide features (6 and 7) are located below the mapped debris flow, further down the subtle seasonal drainage swale.

Shallow debris flows (8) also appear to have occurred along the drainage ravine near the eastern property boundary (south of the proposed subdivision), as evidenced by evacuated headscarps along the northern side of the channel. It appears that these features are related to very steep slopes along either side of the ravine in addition to heavy precipitation during past rainfall events. The deeply incised drainage ravine appears to be exacerbated by the presence of an existing culvert which discharges road runoff from Parrott Drive into the upper area of this feature. Several approximately 20- to 40-foot wide rotational landslide features (9, 10, and 11) are located on the north side of this channel, further downslope. A catchment basin is located near the base of this channel, approximately 20 feet east of the

existing residence. A culvert routes water from the catchment basin, under the existing driveway, and out to Crystal Springs Road. An existing earth swale is located above the catchment basin designed to divert overflow during heavy storm events to the north and away from the residence.

As discussed above, a large presumably ancient landslide (12) appears to extend from the downhill side of Parrott Drive to Crystal Springs Road in the north-central portion of the property. This Ols feature is approximately 500 feet in width and 1,200 feet in length. Two additional large, dormant landslides (13 & 14) are located immediately south of this feature, in the south-central portion of the property. A smaller dormant landslide feature (15) is mapped in the northwestern corner of the site. The larger of the dormant features (14) is approximately 400 feet in width and 1,100 feet in length. The margins of these two features (13 & 14) coincide with a central deeply incised seasonal drainage channel (located south of the ancient landslide and north of the dormant landslide). The channel bounding these features is flanked by numerous, relatively small active landslides (17 through 23). The landslides appear to flank both margins of the channel and appear to be mostly rotational in nature, with 2- to 5-foot tall headscarps observed during site mapping. The features appear to be approximately 50- to 200-foot wide and are characterized by generally hummocky topography. Their activity was presumably triggered by undercutting along the steeply incised seasonal drainage channel during past heavy storm events.

A graded road/path enters the property near the eastern margin of the mapped ancient landslide (Ols) and continues in a southwesterly direction toward the mapped quarry. This grading is associated with the existing sewer line that services residences along Parrott Drive. Along the uphill side of this access road, Franciscan materials are exposed that range from relatively competent rock outcrops to highly sheared, severely to completely weathered materials. During site mapping, we observed an arcuate break in slope below the road, located uphill from boring RWB-4 (see Figure 1 within Landslide 14). While this feature may be a scarp related to past movement, the surrounding topography and relatively close position to the graded access road appear to suggest that this feature is likely a remnant associated with past grading. We did not see additional features similar in nature to this on the property, but it is possible they were obscured by the dense vegetation.

An active relatively shallow landslide (25) is located near the central western portion of the property, within the road cut above Crystal Springs Road. Based on our site reconnaissance, this feature appears to be approximately 200 feet wide and approximately 100 feet in length. The slide mass is characterized by generally hummocky topography and is bounded to the north, east, and south by an approximate 2- to 3-foot tall headscarp. Based on aerial photographs, this feature appears to have activated sometime between 1946 and 1968. In our opinion, grading associated with construction of this over-steepened cut slope along the uphill side of Crystal Springs Road is likely the main probable cause of the landslide; however, quarrying activity associated with the old quarry located uphill and to the south may have contributed to the failure. It appears that this active landslide is relatively shallow, likely less than 10 feet thick in depth.

A debris flow complex (26) was initially mapped by SCI along the drainage swale located southeast of the old quarry. Based on our site reconnaissance and aerial photograph review, a significant amount of erosion has occurred at the head of this feature; however, very dense

vegetation obscures the topography and evidence of past debris flow movement is inconclusive; however, given its geomorphology, in our opinion this area possesses a potential debris source. Additional shallow active landslide features are located within the mapped debris flow.

We note that due to the dense vegetation and steep slope conditions, only portions of the site were accessed by during our site reconnaissance and mapping phase. Therefore, there could be other relatively shallow to moderate slope failures on the property that have not been documented.

RESPONSE TO COUNTY COMMENTS

The comments contained in the County of San Mateo's geotechnical review sheet, dated December 4, 2014, are presented verbatim below in italics. Our responses are presented below each comment in normal-face type.

Comment No. 1:

Supplemental investigation of the site landslide hazards and potential offsite impacts should be completed. This work should include, but not necessarily be limited to, the following:

- A) The approximate area for stabilization repair of active landsliding within Parcels 1 and 2 should be depicted in plan view and cross section. Conceptual design measures should be presented that are intended to prevent future reactivation or enlargement of landsliding across the common property line. If a grading repair is selected, approximate grading volume estimates should be prepared.*

Based on the reconfiguration of parcel boundaries, the majority of the mapped active landslide is located within Parcel 2. Please refer to Figure 1 for the reconfiguration of the proposed parcel lines and refer to Cross Section B-B' (Figure A-7) of MEI's 2014 report for reference. We understand that the project civil engineer will be providing a cross section depicting the proposed landslide repair, including keying and benching details of the fill, fill subdrainage, and grading volumes.

- B) If a fourth residential house site is desired, then consideration should be given to other favorable property slopes that are no steeper than the proposed building areas on Parcels 1, 2, and 3.*

The reconfiguration of the proposed parcel boundaries results in four smaller parcels with slopes that are no steeper than the previous locations of parcels 1 through 3. Specifically, the parcels have been shifted away from the debris flow and steep ravine mapped south of the newly proposed parcel 4. Please refer to our attached site plan for further clarification.

- C) General geologic mapping should be conducted to identify potential areas of the 60.26 acre property that present a moderate to high risk for initiation of slope failures, and have a significant potential for adverse offsite impacts to existing residential developments or roadways. Mapping should include delineation of probable debris transport paths and deposition areas.*

Based on our review of the above information, prior engineering geologic and geotechnical studies, and our recent site mapping activities, it is our opinion that the larger landslide features mapped on the subject property appear relatively stable, as a whole. Specifically, the

larger landslide masses mapped in the central portion of the property, extending from Parrott Drive to Crystal Springs Road, appear to consist of relatively resistant central ridges bounded by incised stream channels with their basal toe likely buttressed by deep soil at the base of the slope fronting Crystal Springs Road. In addition, these features are constrained from significant movement due to its location within a narrow valley. Therefore, in our opinion the potential for full reactivation of these features is relatively low; however, continued erosion along the seasonal drainage channels, loss of lateral support along the lower toe margin area from existing over-steepened road cut slopes, and/or strong earthquake ground shaking may cause partial reactivation(s) along the margins of these features. Although there is evidence of active and past landsliding on the subject property, there is no obvious historic evidence that landsliding on the property has caused any substantial impacts to Crystal Springs Road below. Therefore, in our opinion if partial reactivation of these features were to occur, the probability of this type of slope movement significantly impacting the long-term performance of existing off-site improvements is relatively low. Slope movements affecting existing off-site improvements, such as the road below, will likely result in continued maintenance-level issues and may result in damage and temporary closures of the roadway in local areas. However, this slope stability risk can be expected in this general area along Crystal Springs Road adjacent steep hillside terrain and over-steepened road cut slopes. As stated in our referenced report, we note that although our knowledge of the causes and mechanisms of landslides has greatly increased in recent years, it is not yet possible to predict with certainty exactly when and where all landslides will occur, including deep-seated landslides. At some time over the span of thousands of years, most hillsides will experience landslide movement as mountains are reduced to plains. Therefore, an unknown level of risk is always present to structures located in hilly terrain. Owners of property and government agency infrastructures located in these areas must be aware of and be willing to accept this risk.

As stated above, the margins of the larger, central landslide features have experienced active landsliding in the recent past. Movement along the incised seasonal drainage channels across the properties generally appears to be more rotational in nature, with less evidence of classic debris-flow type movement. The landslides mapped along the channels generally are evidenced by 2- to 5-foot tall headscarps, generally hummocky topography, and, to a lesser extent, slightly deflected channels away from the landslide masses. However, due to the steepness of slopes and the observed erosion/incision, the channels on the property have the potential to become sources and/or pathways for future debris flow movement. Specifically, based on our site reconnaissance, although slope movement in these areas may continue to occur in a more rotational manner, landslide movement into the channel area could impede drainage flow and cause a temporary buildup of water that could trigger debris flow movement. For reference proposes, debris flows, in general, commonly involve upon saturation, the rapid removal of relatively shallow thicknesses of granular soil over a firm contact such as bedrock. The saturated soil is transported, in semi-liquid form, from the upper regions of the debris flow causing a scar to form in this area, and the resulting debris deposited along a relatively narrow band or "pathway" to a termination point below. Depending on many factors including the size, steepness of slope, topography, soil type, etc., structures located immediately below slopes potentially prone to debris flow movement may be in an immediate threat of both structural damage and/or life safety. Mitigation measures such as debris fences, impact walls, or deflection walls are commonly recommended to reduce this potential threat.

Although there remains a risk of future localized landsliding and/or debris flow movement onto Crystal Springs Road, we note that during our supplemental investigation, we observed a series of improvements that appear to be designed to mitigate this concern along portions of this road segment. For example, a concrete retaining wall has been constructed northeast of the intersection of Crystal Springs Road and Tartan Trail Road as well as rock debris fences just south of this area. In addition, various storm drain improvements exist, including several storm drain culverts along the eastern side of Crystal Springs Road. In addition, the headwall areas near the base of the seasonal drainage swales where the storm drains transect beneath the road, did not show significant buildup of debris at the time of our field observations suggesting that they are periodically maintained.

Based on our site observations, we observed that a substantial concrete debris/deflection wall was installed to presumably help protect the school property (Odyssey School) located northeast of the intersection of Crystal Springs Road and Polhemus Road. This wall appears to have ample capacity and a favorable deflection angle to mitigate the concern for potential debris flow impact to the school development initiating from the adjacent seasonal drainage channels located immediately east of this property.

We observed a catchment basin near the base of the seasonal drainage channel above and approximately 20 feet east of the existing residence located approximately 600 feet northeast of the intersection of Crystal Springs Road and Tartan Trail Road. A culvert routes water from the catchment basin, under the existing driveway, and presumably out to Crystal Springs Road. As previously stated, an existing earth swale is located above the catchment basin designed to divert overflow during heavy storm events to the north and away from the residence. These improvements help mitigate the potential concern associated with direct impact from debris flows and significant flooding.

D) Mitigation measure design options should be presented to address unacceptable offsite impacts.

Based on the findings and discussion above, in our opinion new mitigations measures will not be necessary at this time to address offsite impacts primarily because the existing drainage and wall improvements have historically mitigated significant landslide and debris flow hazard concerns. However, there remains a risk that reactivation of the referenced landslide features or activation of new features may result in maintenance-level issues relating to the serviceability of the road below (such as temporary closures due to debris on the roadway). This risk can be expected in any area with over-steepened road cuts below steep hillside terrain. In addition, although very unlikely, there will always remain some life safety risk to drivers or pedestrians associated with slope movement onto the road and for structures built at the base of steep slopes. However, we emphasize that in our opinion this potential risk has been mitigated by the existing improvements mentioned above and is not substantially different than other areas along this same road segment subject to steep slope conditions.

E) Geotechnical design recommendations for the proposed project should be updated as warranted based on identified site conditions.

The geotechnical design recommendations contained in MEI's 2014 report appear to be applicable to the proposed project. If site conditions varying from those described herein and in MEI's 2014 report, we are prepared to update project geotechnical design recommendations as warranted.

Comment No. 2:

Future proposed subdivision plans should be evaluated and approved by the Project Geotechnical Consultant for conformance with recommendations prior to submittal of revised Tentative Map documentation to the County.

MEI is prepared to evaluate future subdivision plans for conformance with geotechnical recommendations.

Limitations

Our supplemental evaluation has been performed and the preceding conclusions have been developed in accordance with engineering geologic and geotechnical engineering principles and practices generally accepted at this time and location. A more detailed investigation that might include detailed site mapping, subsurface exploration and testing, slope stability analyses, and laboratory testing could result in modifications to our limited evaluation. We make no warranty, either expressed or implied.

If you have any questions concerning the content of this letter or other aspects of the project, please call.

Sincerely,

MURRAY ENGINEERS



Kaysea A. Porter, P.G. 9269
Project Geologist

KAP:JAS

Copies: Addressee (3)
MacLeod and Associates (1)
Attn: Mr. Daniel MacLeod, P.E.

Attachments: Figure 1, Site Plan & Engineering Geologic Map



John A. Stillman, G.E., C.E.G. 1868
Principal Geotechnical Engineer

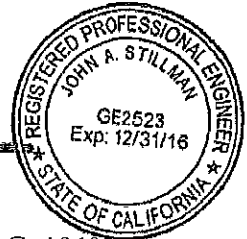

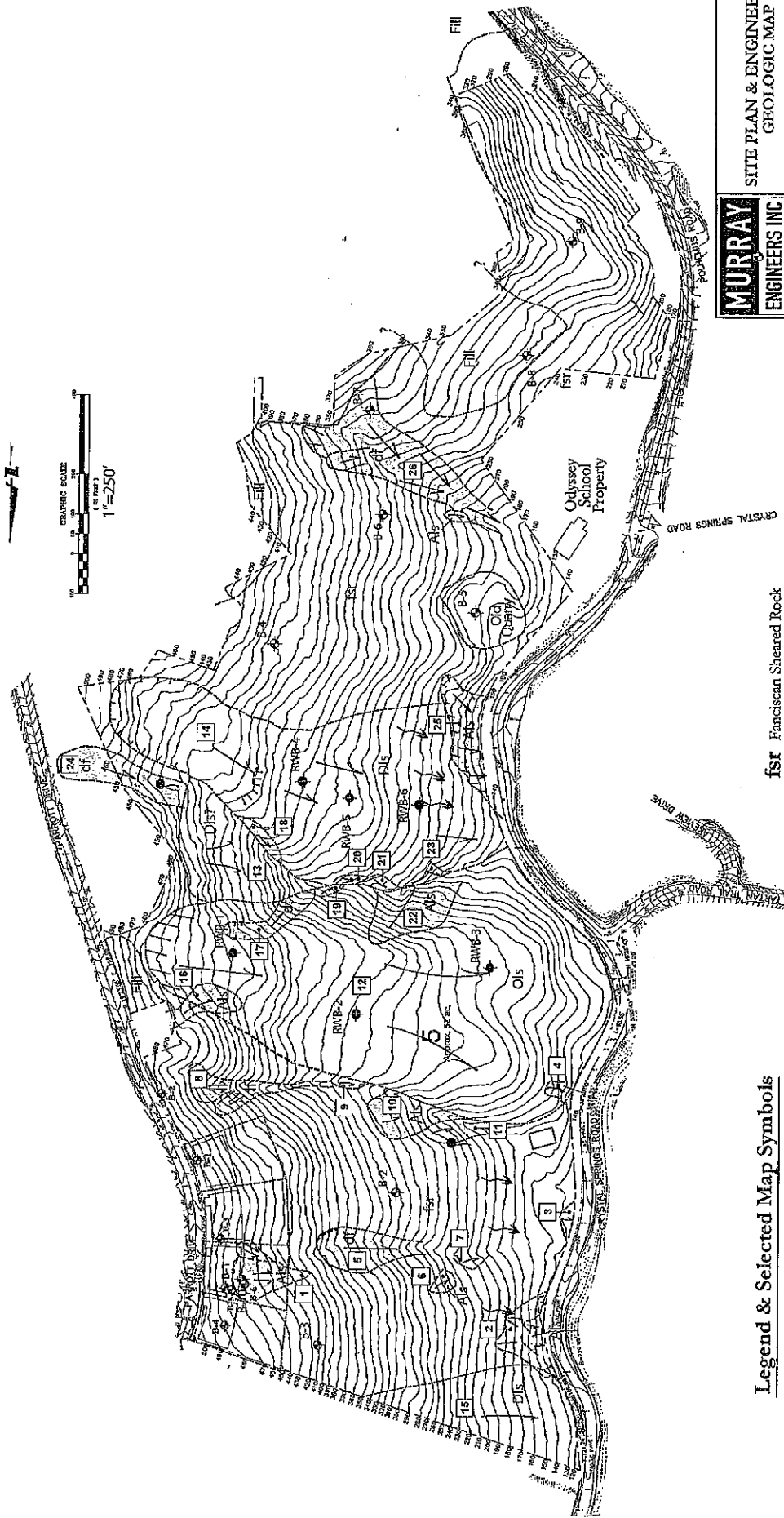

Legend & Selected Map Symbols

- B-1 Approximate Location of Soil Boring by Murray Engineers, Inc, drilled December 20-23, 2013
- B-4 Approximate Location of Soil Borings by BAGG drilled July 18-19, 2007 & October 2, 2007
- Geologic Contact, Dashed where Approximate, Queried Where Uncertain
- Base: Topographic Survey by BKF Engineers, dated January 2, 2007
- Approximate Scale: 1 inch = 100 feet

- fsr Franciscan Sheared Rock
- Ols Older Landslide
- Dls Dormant Landslide
- Als Ancient Landslide
- df Debris Flow

- Landslide Limits
- Proposed Building Site - Typical

MURRAY
ENGINEERS INC
GEOLOGICAL SERVICES

SITE PLAN & ENGINEERING
GEOLOGIC MAP

ZMAY RESIDENTIAL SUBDIVISION
1551 CRYSTAL SPRINGS ROAD
SAN MATEO COUNTY, CALIFORNIA

PROJECT NO.
1847-JL2

APRIL 2015

FIGURE 1

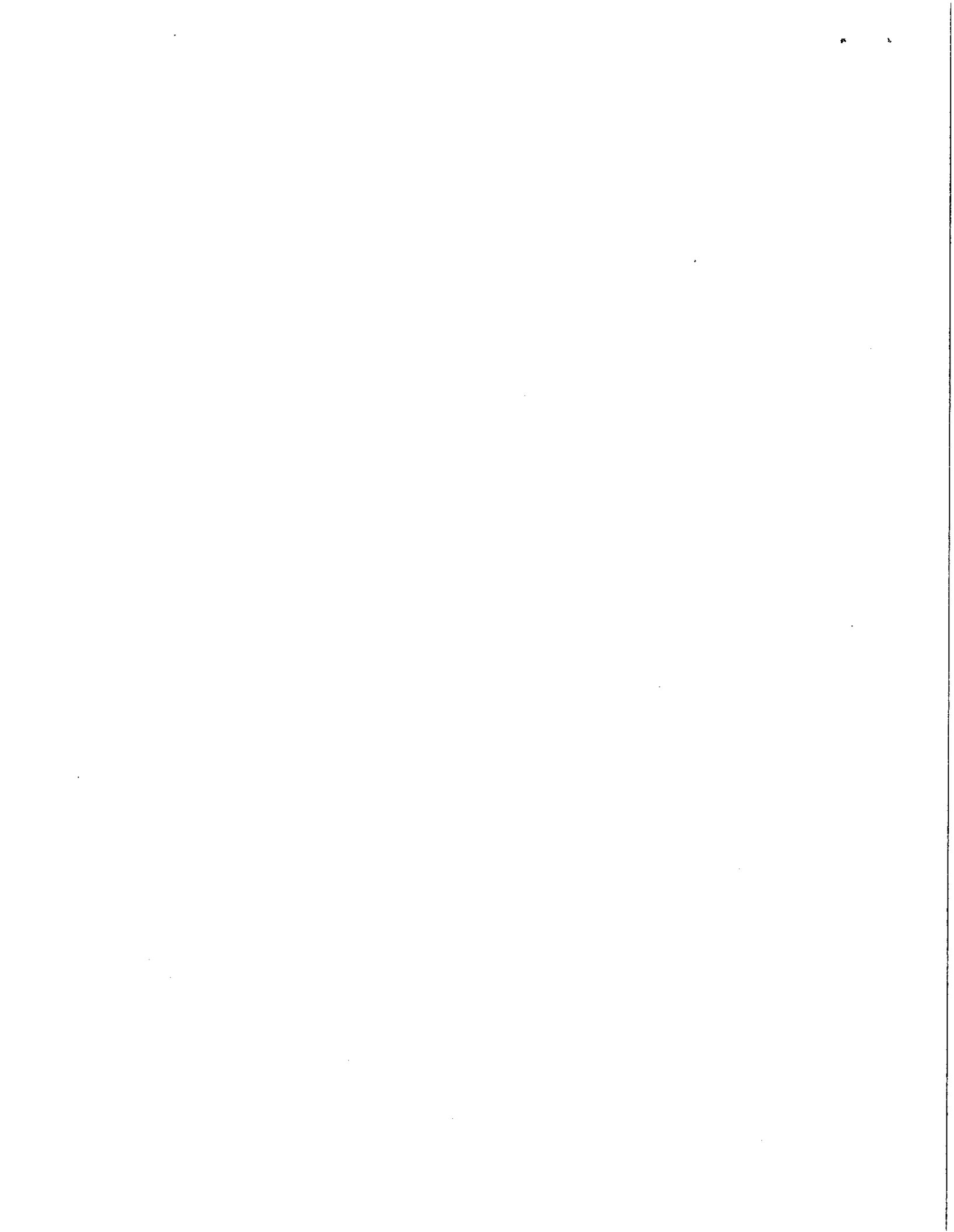

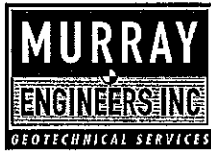

March 18, 2015
Project No. 1847-1L2

Nick Zmay
1551 Crystal Springs Road
Hillsborough, California 94010

**RE: SUPPLEMENTAL EVALUATION &
RESPONSE TO REVIEW COMMENTS,
ZMAY PROPERTY,
1551 CRYSTAL SPRINGS ROAD,
SAN MATEO COUNTY, CALIFORNIA**

Dear Mr. Zmay:

As requested, we have prepared this letter in response to the County of San Mateo's geotechnical review sheet dated December 4, 2014. We have previously conducted an engineering geologic and geotechnical investigation for the development of a four-lot residential subdivision (each containing 2 acres) on the property located at 1551 Crystal Springs Road in an unincorporated area of San Mateo County, near Hillsborough. Our original report was dated February 10, 2014, and summarized the results of our investigation and presented geotechnical design recommendations for the proposed residential subdivision. We prepared a supplemental letter regarding the updated subdivision building envelopes, dated August 26, 2014. In the review sheet, the County presented two review comments. Comment No. 1 requests a supplemental geologic and geotechnical investigation addressing the five sub-comments contained within Comment No. 1. As a part of their comments, they have requested we perform a limited evaluation of the remaining 48 acres of the property. The results of our additional evaluations are presented below, followed by our responses to the County comments. Our responses to the review comments are presented in the same order in which they appear on the geotechnical review sheet.

PROJECT DISCUSSION

Geologic Review

The entire approximate 60 acre property is located on a west-facing hillside in the foothills along the northeast side of the Santa Cruz Mountains, a northwest-trending range within the California Coast Ranges geomorphic province. The local topography is dominated by a series of west-trending spur ridges and intervening seasonal drainage swales. Crystal Springs Road extends along the western property boundary at the base of the hillside and converges with Polhemus Road near the southern corner of the property. San Mateo Creek and Polhemus Creek run parallel to Crystal Springs Road and Polhemus Road, respectively. Elevations across the site range from approximately 500 feet along Parrott Drive in the eastern portion of the site down to approximately 140 feet above mean sea level at the base of the hillside in the northwest corner of the site (see Figure A-1 of Murray Engineers Inc. (MEI's) 2014 report).

According to the Geologic Map of the Montara Mountain and San Mateo 7-1/2' Quadrangles (Pampeyan, 1994), the site is located in an area underlain by Cretaceous and Jurassic age (approximately 65 to 200 million years old) sheared rock of the Franciscan Complex (fsr).



The sheared rock generally consists of soft, light- to dark-gray, sheared shale, siltstone, and greywacke sandstone containing various-size tectonic inclusions of Franciscan rock types. According to the geologic map, the lower portion of the slope in the northwest corner of the property is blanketed by Quaternary slope wash, ravine fill, and colluvium deposits (Qst). These deposits generally consist of unconsolidated to moderately consolidated sand, silt, clay, and rock fragments accumulated by slow downslope movement of weathered rock debris and soil. A copy of the relevant portion of the geologic map is presented on Figure A-3, Vicinity Geologic Map, of MEI's 2014 report.

According to the geologic map, the Geotechnical Hazard Synthesis Map for San Mateo County (Leighton and Associates, 1976), and the Preliminary Map of Landslide Deposits in San Mateo County (Brabb & Pampeyan, 1972), three relatively large landslides are mapped in the central portion of the property. According to the geologic map, the largest feature measures approximately 900 feet in length and 600 feet in width. The upper margin of this feature is located approximately 350 feet to the west (downhill) of Parrott Drive and extends down to Crystal Springs Road. The second mapped landslide is approximately 700 feet long and 500 feet wide and is located immediately south of the first landslide. In addition, smaller landslide features are mapped in the southern portion of the lot and at the northeast corner just off the property. The relevant portions of these maps are included as Figure A-4, San Mateo County Landslide Map and Figure A-5, San Mateo County Geotechnical Hazard Synthesis Map, of MEI's 2014 report.

Previous Relevant Geologic & Geotechnical Investigations

A full discussion of prior geologic and geotechnical investigations was provided in Murray Engineers Inc. (MEI's) 2014 engineering geologic and geotechnical report. However, because the report focused on the subdivision of 8 acres in the upper northeast portion of the property, portions of previous investigations were not discussed in the report. Therefore, we will summarize the relevant information contained in prior reports as it pertains to the County's review comments, listed below; specifically, with respect to the property as a whole and not solely focused on the northeastern portion proposed to be subdivided. For additional information not discussed below, please refer to MEI's 2014 report.

Site Characteristics, Inc. (SCI) conducted a geotechnical investigation on the property, dated July 1983, to address three proposed single family residences along Crystal Springs Road in the northwest lower portion of the property. Subsequently, William Cotton and Associates (WCA) performed a supplemental geotechnical analysis and presented the results in a report dated April 20, 1984. Based on site reconnaissance, subsurface investigations, and slope stability analyses, both consultants indicated that although there were several shallow landslide and slump features on the property, there was no evidence of recent slope instability or of debris flows on the property.

In 2007, Bay Area Geotechnical Group (BAGG) performed a geotechnical and engineering geologic investigation for a proposed 20-lot residential subdivision of the subject property. The results of the investigation were presented in a report dated December 20, 2007. As part of the investigation, BAGG excavated six relatively deep borings within the landslide areas and nine additional borings on the remaining portions of the property, and performed laboratory testing on samples, including triaxial shear and direct shear testing. The locations



of these borings are shown on Figure 1. The results of BAGG's slope stability analyses are discussed in MEI's 2014 report.

In general, BAGG's borings encountered approximately 5 feet of colluvial soil underlain by bedrock associated with the Franciscan Complex. However, Borings B-2 and B-3, located in the northern portion of the property, encountered approximately 17.5 and 12 feet of colluvial soil, respectively, and Borings B-7 and B-8, located in the southern portion of the property, encountered approximately 14.5 and 12 feet of colluvial soil, respectively. According to BAGG, the colluvial soil consists of stiff to very stiff, low to medium plasticity, lean clay, sandy clay, gravelly clay, and silty gravel. The sixteen borings advanced by BAGG all encountered bedrock at depths of approximately 2 to 17.5 feet, consisting of Franciscan materials with varying degrees of weathering and shearing in a clayey matrix. Based on the subsurface investigation, BAGG formed the opinion that although numerous landslide and slump features were found on the property, site development was feasible outside the mapped slide areas.

Aerial Photography Review

Four sets of historical aerial photographs taken between 1943 and 1974 were reviewed at the U.S. Geologic Survey's library in Menlo Park to aid in evaluating the presence of geomorphic features that may be suggestive of landsliding on the entire 60 acre property. The site is readily identifiable in all of the photographs, based on the topography and the location of Parrott Drive, Crystal Springs Road, and Polhemus Road. Other than the development of the neighboring residential properties, there is very little change in the vicinity of the property during the period covered by the photographs. In the 1943 and 1946 photographs, the streets are present but there is no other development in the vicinity of the property. By the time of the 1968 photographs, most of the homes along Parrott Drive are complete and the building pad on the property immediately northeast of the property appears to be graded. In addition, it appears that improvements were made to Parrott Drive and that additional fill was placed along the downhill side of the roadway. The residences that currently exist along Parrott Drive are present by the time of the 1974 photographs.

In the 1943 and 1946 photographs, two large landslides are present in the central portion of the property, similar to mapping by Pampeyan. The landslides are characterized by broad arcuate topography extending from the downhill side of Parrott Drive down to Crystal Springs Road. The ground surface within the limits of the landslides is generally hummocky with irregular medium to dense vegetation. A small debris flow appears to be located within the limits of the northern landslide. In addition, a debris flow (No. 24-see attached site plan) is located uphill of the southern landslide and drops into the upper portion of the landslide feature. The landslide masses are confined by drainage swales extending down the margins of the features to Crystal Springs Road. In addition, a large debris flow-type landslide complex, also mapped by Pampeyan, is located in the southern portion of the property. There are no signs of quarrying near the mapped quarry in either set of photographs.

It appears that sometime between 1946 and 1968, grading activities were conducted near the southeast property corner in the vicinity of Bel Air Road, Linden Lane, and Enchanted Way, presumably associated with the development of properties in this area. The 1968 photographs show a series of graded terraces, with residences built above, that appear to be relatively cleared of vegetation. The 1974 photographs show the same configuration of what

appears to be artificial fill terraces constructed below the residences; however, the ground surface appears to be more vegetated and the terracing is less obvious. Although there is no conclusive evidence to suggest that this grading was conducted as part of a landslide repair, the grading appears to be coincident with the neighborhood located near the southeast property corner and is likely a result of neighborhood development.

In the 1968 photographs, an access road is present near the northeastern property corner. This road enters the subject property from Parrott Drive, extends across the uphill portion (roughly parallel to Parrott Drive) and to the graded pad on the adjacent northern property. It appears that sometime between 1968 and 1974, a small landslide occurred along the downhill side of this access road. A headscarp is present along the uphill margin of this arcuate feature in the 1974 photographs. No evidence of landsliding was observed immediately east of this feature, however, there is a tonal variation in the vegetation and the topography has a very subdued arcuate shape, suggesting that this area may be prone to shallow sliding.

In the 1968 and 1974 photographs, the quarry appears to be active or recently active, evidenced by a bare hillside with little to no vegetation. The mapped landslide immediately north of the quarry (on the eastern side of Crystal Springs Road) appears to have activated sometime between 1946 and 1968, possibly as a result of quarrying activities or due the generation of over-steepened road cuts in this area. A headscarp is present along the uphill margin of this arcuate feature in the 1968 and 1974 photographs and the ground surface within the limits of the landslide is generally hummocky.

The drainage swales located across the property are densely vegetated in the photographs. Any conclusive evidence suggestive of landsliding or debris flows is obscured along these channels.

Supplemental Geologic Mapping

As part of the supplemental evaluation, our project geologist and principal geotechnical engineer conducted additional limited geologic mapping on the property on March 2, 2015. The results of this supplemental geologic mapping and site reconnaissance are included on the Site Plan and Engineering Geologic Map (Figure 1). Due to the scale of the attached site plan and the large area encompassed by the property, we have identified the more significant landslide features on Figure 1 but note that there may be additional shallow features on the property that are not depicted on the map. A brief discussion of the prominent mapped features is included in MEI's 2014 report and the general locations of these features are shown on Figure 1. More detailed discussions of the property are presented in MEI's 2014 report.

As previously discussed, the site topography is dominated by a series of westerly-trending spur ridges and intervening drainage swales. The natural ground surface across the property is generally steep with gradients varying from 2:1 to 3:1 (horizontal to vertical) and moderately sloping across portions of the mapped landslides with gradients ranging from approximately 4:1 to 5:1. Steeper than 2:1 slopes are present, however, particularly along steep ravines associated with the seasonal drainage swales and pre-existing road and quarry cuts.

Below is a discussion of the landslide features mapped on Figure 1, moving north to south across the property. For ease of reference, these features discussed below are also numbered on Figure 1.

An active relatively shallow landslide (1) is located near the northeastern property corner within the proposed Lot 2 of the referenced 4-lot subdivision. Based on our review of aerial photographs, our site reconnaissance, and as previously discussed in our referenced subdivision report, it appears that a 40-foot wide failure appears to have occurred along the downhill side of the graded access road, widening the area of the active landslide from what was previously mapped. This active landslide was absent from the 1943 and 1968 aerial photographs, but appeared in the latest photographs following construction of the graded access road (as discussed above). In our opinion, grading associated with construction of this road is likely the main probable cause of the landslide. It appears that this active landslide is less than 10 feet thick in depth.

An additional active, relatively shallow landslide (2) is located near the northwest property corner, along the road cut above Crystal Springs Road. Based on our site reconnaissance, this feature appears to be approximately 200 feet wide and approximately 100 feet in length. The slide mass is characterized by generally hummocky topography. In our opinion, grading associated with construction of Crystal Springs Road is likely the main probable cause for activation of the landslide. It appears that this active landslide is relatively shallow, likely less than 10 feet thick in depth. Two similar, smaller features (3 and 4) are located further south along Crystal Springs Road with slide mass dimensions of approximately 75 feet wide and approximately 25 feet in length and approximately 50 feet wide and approximately 60 feet in length, respectively.

A debris flow type feature (5) was initially mapped by SCI along the drainage swale below the active landslide in the northeastern property corner, below the proposed lots 2 and 3; however, this feature was questioned by WCA. This feature was subsequently mapped again by BAGG. Based on our site reconnaissance and aerial photograph review, a significant amount of erosion has occurred at the head of this feature; however, very dense vegetation obscures the topography. Additional small shallow landslide features (6 and 7) are located below the mapped debris flow, further down the subtle seasonal drainage swale.

Shallow debris flows (8) also appear to have occurred along the drainage ravine near the eastern property boundary (south of the proposed subdivision), as evidenced by evacuated headscarps along the northern side of the channel. It appears that these features are related to very steep slopes along either side of the ravine in addition to heavy precipitation during past rainfall events. The deeply incised drainage ravine appears to be exacerbated by the presence of an existing culvert which discharges road runoff from Parrott Drive into the upper area of this feature. Several approximately 20- to 40-foot wide rotational landslide features (9, 10, and 11) are located on the north side of this channel, further downslope. A catchment basin is located near the base of this channel, approximately 20 feet east of the existing residence. A culvert routes water from the catchment basin, under the existing driveway, and out to Crystal Springs Road. An existing earth swale is located above the catchment basin designed to divert overflow during heavy storm events to the north and away from the residence.

As discussed above, a large presumably ancient landslide (12) appears to extend from the downhill side of Parrott Drive to Crystal Springs Road in the north-central portion of the property. This Ols feature is approximately 500 feet in width and 1,200 feet in length. Two additional large, dormant landslides (13 & 14) are located immediately south of this feature, in the south-central portion of the property. A smaller dormant landslide feature (15) is mapped in the northwestern corner of the site. The larger of the dormant features (14) is approximately 400 feet in width and 1,100 feet in length. The margins of these two features (13 & 14) coincide with a central deeply incised seasonal drainage channel (located south of the ancient landslide and north of the dormant landslide). The channel bounding these features is flanked by numerous, relatively small active landslides (17 through 23). The landslides appear to flank both margins of the channel and appear to be mostly rotational in nature, with 2- to 5-foot tall headscarps observed during site mapping. The features appear to be approximately 50- to 200-feet wide and are characterized by generally hummocky topography. Their activity was presumably triggered by undercutting along the steeply incised seasonal drainage channel during past heavy storm events.

A graded road/path enters the property near the eastern margin of the mapped ancient landslide (Ols) and continues in a southwesterly direction toward the mapped quarry. This grading is associated with the existing sewer line that services residences along Parrott Drive. Along the uphill side of this access road, Franciscan materials are exposed that range from relatively competent rock outcrops to highly sheared, severely to completely weathered materials. During site mapping, we observed an arcuate break in slope below the road, located uphill from boring RWB-4 (see Figure 1 within Landslide 14). While this feature may be a scarp related to past movement, the surrounding topography and relatively close position to the graded access road appear to suggest that this feature is likely a remnant associated with past grading. We did not see additional features similar in nature to this on the property, but it is possible they were obscured by the dense vegetation.

An active relatively shallow landslide (25) is located near the central western portion of the property, within the road cut above Crystal Springs Road. Based on our site reconnaissance, this feature appears to be approximately 200 feet wide and approximately 100 feet in length. The slide mass is characterized by generally hummocky topography and is bounded to the north, east, and south by an approximate 2- to 3-foot tall headscarp. Based on aerial photographs, this feature appears to have activated sometime between 1946 and 1968. In our opinion, grading associated with construction of this over-steepened cut slope along the uphill side of Crystal Springs Road is likely the main probable cause of the landslide; however, quarrying activity associated with the old quarry located uphill and to the south may have contributed to the failure. It appears that this active landslide is relatively shallow, likely less than 10 feet thick in depth.

A debris flow complex (26) was initially mapped by SCI along the drainage swale located southeast of the old quarry. Based on our site reconnaissance and aerial photograph review, a significant amount of erosion has occurred at the head of this feature; however, very dense vegetation obscures the topography and evidence of past debris flow movement is inconclusive; however, given its geomorphology, in our opinion this area possesses a potential debris source. Additional shallow active landslide features are located within the mapped debris flow.

We note that due to the dense vegetation and steep slope conditions, only portions of the site were accessed by during our site reconnaissance and mapping phase. Therefore, there could be other relatively shallow to moderate slope failures on the property that have not been documented.

RESPONSE TO COUNTY COMMENTS

The comments contained in the County of San Mateo's geotechnical review sheet, dated December 4, 2014, are presented verbatim below in italics. Our responses are presented below each comment in normal-face type.

Comment No. 1:

Supplemental investigation of the site landslide hazards and potential offsite impacts should be completed. This work should include, but not necessarily be limited to, the following:

- A) The approximate area for stabilization repair of active landsliding within Parcels 1 and 2 should be depicted in plan view and cross section. Conceptual design measures should be presented that are intended to prevent future reactivation or enlargement of landsliding across the common property line. If a grading repair is selected, approximate grading volume estimates should be prepared.*

Based on the reconfiguration of parcel boundaries, the majority of the mapped active landslide is located within Parcel 2. Please refer to Figure 1 for the reconfiguration of the proposed parcel lines and refer to Cross Section B-B' (Figure A-7) of MEI's 2014 report for reference. We understand that the project civil engineer will be providing a cross section depicting the proposed landslide repair, including keying and benching details of the fill, fill subdrainage, and grading volumes.

- B) If a fourth residential house site is desired, then consideration should be given to other favorable property slopes that are no steeper than the proposed building areas on Parcels 1, 2, and 3.*

The reconfiguration of the proposed parcel boundaries results in four smaller parcels with slopes that are no steeper than the previous locations of parcels 1 through 3. Specifically, the parcels have been shifted away from the debris flow and steep ravine mapped south of the newly proposed parcel 4. Please refer to our attached site plan for further clarification.

- C) General geologic mapping should be conducted to identify potential areas of the 60.26 acre property that present a moderate to high risk for initiation of slope failures, and have a significant potential for adverse offsite impacts to existing residential developments or roadways. Mapping should include delineation of probable debris transport paths and deposition areas.*

Based on our review of the above information, prior engineering geologic and geotechnical studies, and our recent site mapping activities, it is our opinion that the larger landslide features mapped on the subject property appear relatively stable, as a whole. Specifically, the larger landslide masses mapped in the central portion of the property, extending from Parrott Drive to Crystal Springs Road, appear to consist of relatively resistant central ridges bounded by incised stream channels with their basal toe likely buttressed by deep soil at the base of the slope fronting Crystal Springs Road. In addition, these features are constrained from significant movement due to its location within a narrow valley. Therefore, in our

opinion the potential for full reactivation of these features is relatively low; however, continued erosion along the seasonal drainage channels, loss of lateral support along the lower toe margin area from existing over-steepened road cut slopes, and/or strong earthquake ground shaking may cause partial reactivation(s) along the margins of these features. Although there is evidence of active and past landsliding on the subject property, there is no obvious historic evidence that landsliding on the property has caused any substantial impacts to Crystal Springs Road below. Therefore, in our opinion if partial reactivation of these features were to occur, the probability of this type of slope movement significantly impacting the long-term performance of existing off-site improvements is relatively low. Slope movements affecting existing off-site improvements, such as the road below, will likely result in continued maintenance-level issues and may result in damage and temporary closures of the roadway in local areas. However, this slope stability risk can be expected in this general area along Crystal Springs Road adjacent steep hillside terrain and over-steepened road cut slopes. As stated in our referenced report, we note that although our knowledge of the causes and mechanisms of landslides has greatly increased in recent years, it is not yet possible to predict with certainty exactly when and where all landslides will occur, including deep-seated landslides. At some time over the span of thousands of years, most hillsides will experience landslide movement as mountains are reduced to plains. Therefore, an unknown level of risk is always present to structures located in hilly terrain. Owners of property and government agency infrastructures located in these areas must be aware of and be willing to accept this risk.

As stated above, the margins of the larger, central landslide features have experienced active landsliding in the recent past. Movement along the incised seasonal drainage channels across the properties generally appears to be more rotational in nature, with less evidence of classic debris-flow type movement. The landslides mapped along the channels generally are evidenced by 2- to 5-foot tall headscarps, generally hummocky topography, and, to a lesser extent, slightly deflected channels away from the landslide masses. However, due to the steepness of slopes and the observed erosion/incision, the channels on the property have the potential to become sources and/or pathways for future debris flow movement. Specifically, based on our site reconnaissance, although slope movement in these areas may continue to occur in a more rotational manner, landslide movement into the channel area could impede drainage flow and cause a temporary buildup of water that could trigger debris flow movement. For reference proposes, debris flows, in general, commonly involve upon saturation, the rapid removal of relatively shallow thicknesses of granular soil over a firm contact such as bedrock. The saturated soil is transported, in semi-liquid form, from the upper regions of the debris flow causing a scar to form in this area, and the resulting debris deposited along a relatively narrow band or "pathway" to a termination point below. Depending on many factors including the size, steepness of slope, topography, soil type, etc., structures located immediately below slopes potentially prone to debris flow movement may be in an immediate threat of both structural damage and/or life safety. Mitigation measures such as debris fences, impact walls, or deflection walls are commonly recommended to reduce this potential threat.

Although there remains a risk of future localized landsliding and/or debris flow movement onto Crystal Springs Road, we note that during our supplemental investigation, we observed a series of improvements that appear to be designed to mitigate this concern along portions of this road segment. For example, a concrete retaining wall has been constructed northeast

of the intersection of Crystal Springs Road and Tartan Trail Road as well as rock debris fences just south of this area. In addition, various storm drain improvements exist, including several storm drain culverts along the eastern side of Crystal Springs Road. In addition, the headwall areas near the base of the seasonal drainage swales where the storm drains transect beneath the road, did not show significant buildup of debris at the time of our field observations suggesting that they are periodically maintained.

Based on our site observations, we observed that a substantial concrete debris/deflection wall was installed to presumably help protect the school property (Odyssey School) located northeast of the intersection of Crystal Springs Road and Polhemus Road. This wall appears to have ample capacity and a favorable deflection angle to mitigate the concern for potential debris flow impact to the school development initiating from the adjacent seasonal drainage channels located immediately east of this property..

We observed a catchment basin near the base of the seasonal drainage channel above and approximately 20 feet east of the existing residence located approximately 600 feet northeast of the intersection of Crystal Springs Road and Tartan Trail Road. A culvert routes water from the catchment basin, under the existing driveway, and presumably out to Crystal Springs Road. As previously stated, an existing earth swale is located above the catchment basin designed to divert overflow during heavy storm events to the north and away from the residence. These improvements help mitigate the potential concern associated with direct impact from debris flows and significant flooding.

D) Mitigation measure design options should be presented to address unacceptable offsite impacts.

Based on the findings and discussion above, in our opinion new mitigations measures will not be necessary at this time to address offsite impacts primarily because the existing drainage and wall improvements have historically mitigated significant landslide and debris flow hazard concerns. However, there remains a risk that reactivation of the referenced landslide features or activation of new features may result in maintenance-level issues relating to the serviceability of the road below (such as temporary closures due to debris on the roadway). This risk can be expected in any area with over-steepened road cuts below steep hillside terrain. In addition, although very unlikely, there will always remain some life safety risk to drivers or pedestrians associated with slope movement onto the road and for structures built at the base of steep slopes. However, we emphasize that in our opinion this potential risk has been mitigated by the existing improvements mentioned above and is not substantially different than other areas along this same road segment subject to steep slope conditions.

E) Geotechnical design recommendations for the proposed project should be updated as warranted based on identified site conditions.

The geotechnical design recommendations contained in MEI's 2014 report appear to be applicable to the proposed project. If site conditions varying from those described herein and in MEI's 2014 report, we are prepared to update project geotechnical design recommendations as warranted.



Comment No. 2:

Future proposed subdivision plans should be evaluated and approved by the Project Geotechnical Consultant for conformance with recommendations prior to submittal of revised Tentative Map documentation to the County.

MEI is prepared to evaluate future subdivision plans for conformance with geotechnical recommendations.

Limitations

Our supplemental evaluation has been performed and the preceding conclusions have been developed in accordance with engineering geologic and geotechnical engineering principles and practices generally accepted at this time and location. A more detailed investigation that might include detailed site mapping, subsurface exploration and testing, slope stability analyses, and laboratory testing could result in modifications to our limited evaluation. We make no warranty, either expressed or implied.

If you have any questions concerning the content of this letter or other aspects of the project, please call.

Sincerely,

MURRAY ENGINEERS



Kaysea A. Porter, P.G. 9269
Project Geologist

KAP:JAS

Copies: Addressee (3)
MacLeod and Associates (1)
Attn: Mr. Daniel MacLeod, P.E.

Attachments: Figure 1, Site Plan & Engineering Geologic Map



John A. Stillman, G.E., C.E.G. 1868
Principal Geotechnical Engineer

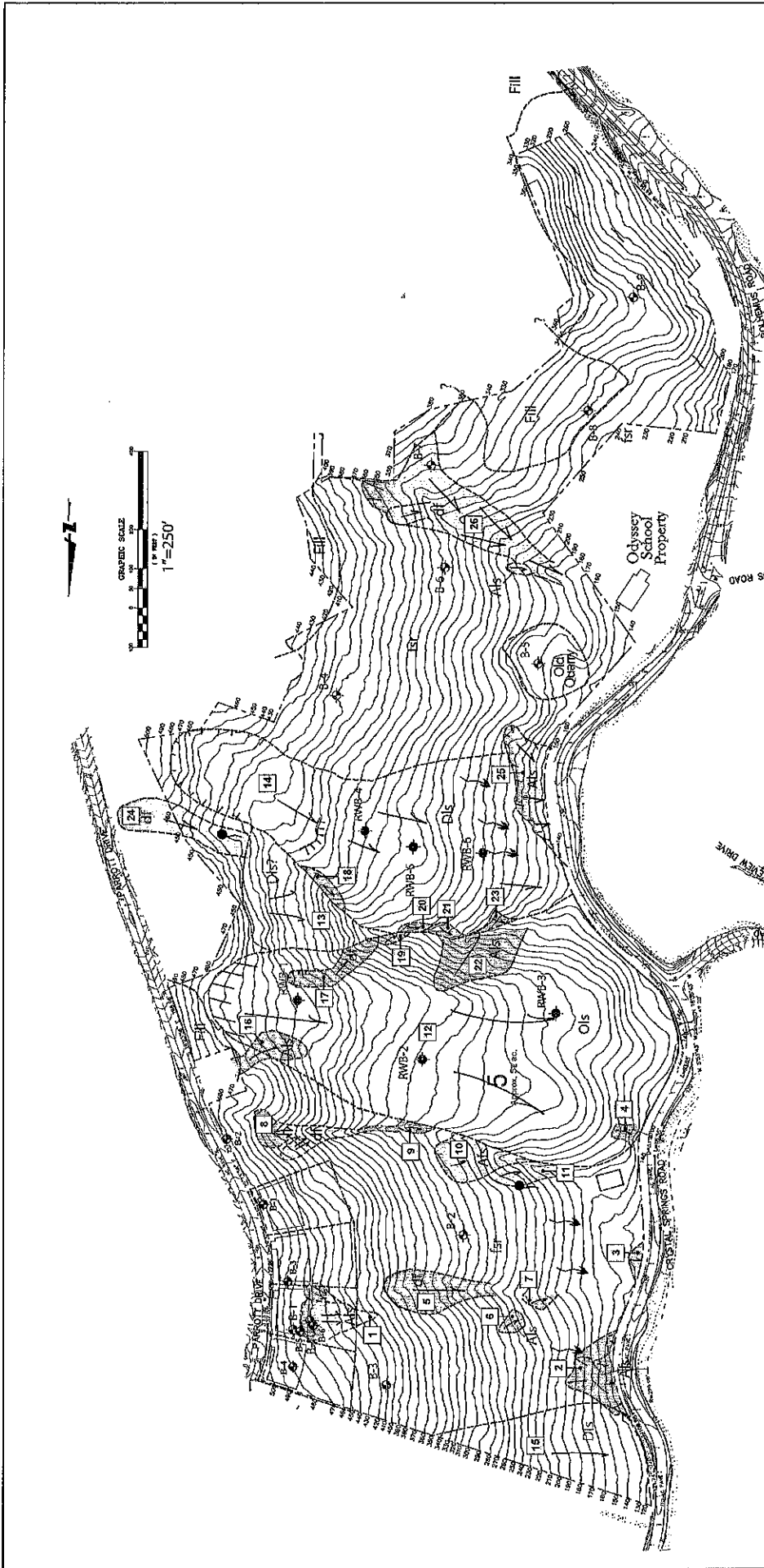

SITE PLAN & ENGINEERING
GEOLOGIC MAP

ZMAY RESIDENTIAL SUBDIVISION
1551 CRYSTAL SPRINGS ROAD
SAN MATEO COUNTY, CALIFORNIA

PROJECT NO.
1847-1L1

MARCH 2015

FIGURE 1

Legend & Selected Map Symbols

- B-1 ◆ Approximate Location of Soil Boring by Murray Engineers, Inc., drilled December 20-23, 2013
- RWB-1 / ◆ B-4 Approximate Location of Soil Borings by BAGG drilled July 18-19, 2007 & October 2, 2007
- ? Geologic Contact, Dashed where Approximate, Queried Where Uncertain
- Base: Topographic Survey by BKF Engineers, dated January 2, 2007
- Approximate Scale: 1 inch = 100 feet
- fsr Fanciscan Sheared Rock
- Ols Older Landslide
- Dis Dormant Landslide
- Als Ancient Landslide
- df Debris Flow
- Proposed Building Site - Typical
- Landslide Limits



County of San Mateo - Planning and Building Department

ATTACHMENT M



July 14, 2015
G5164A

TO: Erica Adams
Planner III
Planning and Building Department
455 County Center, 2nd Floor
Redwood City, California 94063

SUBJECT: Supplemental Geologic and Geotechnical Peer Review
RE: Zmay Minor Subdivision and RMD Permit
PLN: 2014-00410
APN 038131110 (60.26 Acre Parcel)
1551 Crystal Springs Road, San Mateo County, California

We have completed a supplemental geologic and geotechnical peer review of the application for site subdivision using:

- Geotechnical Plan Review - Zmay 4 Lot Subdivision (letter) prepared by Murray Engineers, Inc., dated June 3, 2015;
- Geotechnical Plan Review – Landslide repair (letter) prepared by Murray Engineers, Inc., dated May 28, 2015;
- Supplemental Evaluation & Response to Review Comments (letter-report) prepared by Murray Engineers, Inc., dated April 15, 2015;
- Grading and Drainage Plan for Slide Repair (Sheet C-1) prepared by MacLeod and Associates, with revision date of May 18, 2015;
- Vesting Tentative Parcel Map (2 sheets, various scales) prepared by MacLeod and Associates, with latest revision date of May 29, 2015; and
- Engineering Geologic & Geotechnical Investigation: 4-Lot Residential Development, Zmay Property (report) prepared by Murray Engineers, Inc., dated February 10, 2014.

In addition, we have reviewed pertinent technical maps, aerial photographs, and reports from our office files and completed a reconnaissance along Crystal Springs Road and adjoining slopes with the Project Geotechnical Consultant.

DISCUSSION

The applicant proposes to subdivide the subject 60.26 acre parcel into four 0.73 acre lots with a 57.33 acre remainder parcel. Approximately 48.25 acres of the remainder is a proposed Conservation Easement/Open Space. Approximately 9.08 acres of the remainder parcel along Crystal Springs Road is to be excluded from the Conservation Easement and remain buildable. An existing residence is located on the subject 9.08 acres. In our previous project geologic and geotechnical peer review (dated December 4, 2014), we recommended that supplemental site investigation be undertaken to address the potential for adverse offsite impacts from slope failure within the remainder parcel. We also noted that very steep building site slopes within proposed Parcel 4 were not consistent with prevailing standards. We recommended that a specific repair plan be prepared for the active landslide located on the currently proposed Parcel 2.

Currently proposed Parcels 1, 2, 3, and 4 are located along the outboard side of Parrott Drive. We understand that septic effluent from the parcels would be pumped to the existing sanitary sewer beneath Parrott Drive. The locations of these 4 proposed parcels have been adjusted to avoid steeper slope conditions and the potential for slope instability within the previously proposed Parcel 4.

RECENT GEOLOGIC AND GEOTECHNICAL EVALUATIONS

The Project Geotechnical Consultant has completed supplemental evaluations focused primarily on slope stability conditions within the proposed remainder parcel. The Consultant identified and addressed 26 specific landslide areas within the remainder parcel. The Consultant concluded that existing drainage and diversion wall improvements have historically mitigated significant landslide and debris flow hazards concerns to offsite areas. Gross slope conditions appear to be unchanged since 1943 aerial photographs. Two relatively small areas of shallow slope instability have been active along the eastern side of Crystal Springs Road. Periodic maintenance of storm drain culverts beneath this roadway has apparently prevented significant buildup of debris at culvert inlets.

The Consultant concludes that the potential for deep-seated landsliding within the remainder parcel to impact offsite improvements (including perimeter roadways) is relatively low. However, continued ongoing periodic maintenance will be required to address shallow movement of earth debris onto Crystal Springs Road. The Consultant concludes that the proposed subdivision is feasible from a geotechnical perspective and that submitted plans are in general conformance with presented design recommendations.

CONCLUSIONS AND RECOMMENDED ACTION

We conclude that the Consultant has adequately demonstrated the geotechnical feasibility of residential development of Parcels 1 through 4 as long as the area of active landsliding within Parcel 2 is stabilized as a subdivision-level improvement. To prevent potential undermining of residential improvements on Parcels 1 and 3, it is important that landslide repair be completed within Parcel 2 prior to any individual lot residential construction. All subdrain alignments within the repair should be accurately surveyed during construction so that future pier-supported foundations do not interfere with constructed subdrain systems.

Residential development within the delineated building envelopes of Parcels 1 through 4 would occur across existing slopes in the range of 40 to 50 percent inclination. Local slopes are mantled by several feet of potentially unstable colluvium. Consequently, unsupported large cuts and fills should be avoided from a slope stability perspective. All significant future fills proposed across steep slopes should be keyed and benched into competent bedrock. Murray Engineers has recommended that new residences be supported by pier foundations with piers extending a minimum of 12 feet into bedrock. Our geotechnical approval of residential building envelopes on Parcels 1 through 4 is contingent on geotechnical design parameters not being less conservative than those presented in the referenced February 2014 Murray Engineers report. In addition, we recommend that the following conditions be attached to geotechnical approval of Vesting Tentative Parcel Map:

1. Landslide Repair Parcel 2 – The landslide repair on Parcel 2 shall be completed as a subdivision-level improvement prior to the construction of any residential structures on any parcel. All fill material for the repair shall be keyed and benched into competent bedrock (not into soil as indicated on the referenced C-1). The fill slope for the repair exceeds 30 feet in height and consequently the final design shall include intermediate surface drainage control measures. A condition for preparation of a surveyed, as-built subdrain plan shall be added to the proposed repair plan. A modified design plan should be prepared, approval by the Project Geotechnical Consultant, and submitted to the County for approval prior to the initiation of grading repair work.
2. Grading Restrictions – No cut or fill exceeding 5 feet in vertical dimension shall be permitted on Parcels 1 through 4 unless supported by an engineered retaining wall. Grading and drainage plans for each lot shall be reviewed from a geotechnical

perspective by the County prior to approval of building or grading permits on Parcels 1 through 4. Foundation design on Parcel 2 shall be checked against the as-built subdrain plan for the landslide repair.

3. Geotechnical Design Parameters – Final geotechnical design parameters to be utilized for residential construction on Parcels 1 through 4 shall not be less conservative than design recommendations presented in the Engineering Geologic & Geotechnical Report by Murray Engineers, Inc., dated February 10, 2014.

LIMITATIONS

This supplemental geologic and geotechnical peer review has been performed to provide technical advice to assist the County with its discretionary permit decisions. Our services have been limited to review of the documents previously identified, and a visual review of the property. Our opinions and conclusions are made in accordance with generally accepted principles and practices of the geotechnical profession. This warranty is in lieu of all other warranties, either expressed or implied.

Respectfully submitted,

COTTON, SHIRES AND ASSOCIATES, INC.
COUNTY GEOLOGIC AND GEOTECHNICAL CONSULTANT

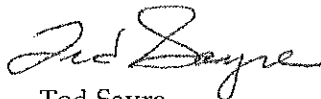

Ted Sayre
Principal Engineering Geologist
CEG 1795

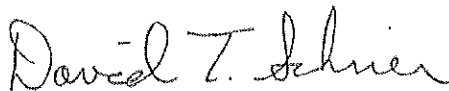

David T. Schrier
Principal Geotechnical Engineer
GE 2334

TS:DTS:kc

June 24, 2015
G5164A

TO: Erica Adams
Planner III
Planning and Building Department
455 County Center, 2nd Floor
Redwood City, California 94063

SUBJECT: **Supplemental Geologic and Geotechnical Peer Review**
RE: Zmay Minor Subdivision and RMD Permit
PLN: 2014-00410
APN 038131110 (60.26 Acre Parcel)
1551 Crystal Springs Road, San Mateo County, California

We have completed a supplemental geologic and geotechnical peer review of the application for site subdivision using:

- Geotechnical Plan Review - Zmay 4 Lot Subdivision (letter) prepared by Murray Engineers, Inc., dated June 3, 2015;
- Geotechnical Plan Review – Landslide repair (letter) prepared by Murray Engineers, Inc., dated May 28, 2015;
- Supplemental Evaluation & Response to Review Comments (letter-report) prepared by Murray Engineers, Inc., dated April 15, 2015;
- Grading and Drainage Plan for Slide Repair (Sheet C-1) prepared by MacLeod and Associates, with revision date of May 18, 2015;
- Vesting Tentative Parcel Map (2 sheets, various scales) prepared by MacLeod and Associates, with latest revision date of May 29, 2015; and

- Engineering Geologic & Geotechnical Investigation: 4-Lot Residential Development, Zmay Property (report) prepared by Murray Engineers, Inc., dated February 10, 2014.

In addition, we have reviewed pertinent technical maps, aerial photographs, and reports from our office files and completed a reconnaissance along Crystal Springs Road and adjoining slopes with the Project Geotechnical Consultant.

DISCUSSION

The applicant proposes to subdivide the subject 60.26 acre parcel into four 0.73 acre lots with a 57.33 acre remainder parcel. Approximately 48.25 acres of the remainder is a proposed Conservation Easement/Open Space. Approximately 9.08 acres of the remainder parcel along Crystal Springs Road is to be excluded from the Conservation Easement and remain buildable. An existing residence is located on the subject 9.08 acres. In our previous project geologic and geotechnical peer review (dated December 4, 2014), we recommended that supplemental site investigation be undertaken to address the potential for adverse offsite impacts from slope failure within the remainder parcel. We also noted that very steep building site slopes within proposed Parcel 4 were not consistent with prevailing standards. We recommended that a specific repair plan be prepared for the active landslide located on the currently proposed Parcel 2.

Currently proposed Parcels 1, 2, 3, and 4 are located along the outboard side of Parrott Drive. We understand that septic effluent from the parcels would be pumped to the existing sanitary sewer beneath Parrott Drive. The locations of these 4 proposed parcels have been adjusted to avoid steeper slope conditions and the potential for slope instability within the previously proposed Parcel 4.

RECENT GEOLOGIC AND GEOTECHNICAL EVALUATIONS

The Project Geotechnical Consultant has completed supplemental evaluations focused primarily on slope stability conditions within the proposed remainder parcel. The Consultant identified and addressed 26 specific landslide areas within the remainder parcel. The Consultant concluded that existing drainage and diversion wall improvements have historically mitigated significant landslide and debris flow hazards concerns to offsite areas. Gross slope conditions appear to be unchanged since 1943

aerial photographs. Two relatively small areas of shallow slope instability have been active along the eastern side of Crystal Springs Road. Periodic maintenance of storm drain culverts beneath this roadway has apparently prevented significant buildup of debris at culvert inlets.

The Consultant concludes that the potential for deep-seated landsliding within the remainder parcel to impact offsite improvements (including perimeter roadways) is relatively low. However, continued ongoing periodic maintenance will be required to address shallow movement of earth debris onto Crystal Springs Road. The Consultant concludes that the proposed subdivision is feasible from a geotechnical perspective and that submitted plans are in general conformance with presented design recommendations.

CONCLUSIONS AND RECOMMENDED ACTION

We conclude that the Consultant has adequately demonstrated the geotechnical feasibility of residential development of Parcels 1 through 4 as long as the area of active landsliding within Parcel 2 is stabilized as a subdivision-level improvement. To prevent potential undermining of residential improvements on Parcels 1 and 3, it is important that landslide repair be completed within Parcel 2 prior to any individual lot residential construction. All subdrain alignments within the repair should be accurately surveyed during construction so that future pier-supported foundations do not interfere with constructed subdrain systems.

Residential development within the delineated building envelopes of Parcels 1 through 4 would occur across existing slopes in the range of 40 to 50 percent inclination. Local slopes are mantled by several feet of potentially unstable colluvium. Consequently, unsupported large cuts and fills should be avoided from a slope stability perspective. All significant future fills proposed across steep slopes should be keyed and benched into competent bedrock. Murray Engineers has recommended that new residences be supported by pier foundations with piers extending a minimum of 12 feet into bedrock. Our geotechnical approval of residential building envelopes on Parcels 1 through 4 is contingent on geotechnical design parameters not being less conservative than those presented in the referenced February 2014 Murray Engineers report. In addition, we recommend that the following conditions be attached to geotechnical approval of Vesting Tentative Parcel Map:

1. Landslide Repair Parcel 2 – The landslide repair on Parcel 2 shall be completed as a subdivision-level improvement prior to the

construction of any residential structures. All fill material for the repair shall be keyed and benched into competent bedrock (not into soil as indicated on the referenced C-1). The fill slope for the repair exceeds 30 feet in height and consequently the final design shall include intermediate surface drainage control measures. A condition for preparation of a surveyed, as-built subdrain plan shall be added to the proposed repair plan. A modified design plan should be prepared, approval by the Project Geotechnical Consultant, and submitted to the County for approval prior to the initiation of grading repair work.

2. **Grading Restrictions** – No cut or fill exceeding 5 feet in vertical dimension shall be permitted on Parcels 1 through 4 unless supported by an engineered retaining wall. Grading and drainage plans for each lot shall be reviewed from a geotechnical perspective by the County prior to approval of building or grading permits on Parcels 1 through 4. Foundation design on Parcel 2 shall be checked against the as-built subdrain plan for the landslide repair.

3. **Geotechnical Design Parameters** – Final geotechnical design parameters to be utilized for residential construction on Parcels 1 through 4 shall not be less conservative than design recommendations presented in the Engineering Geologic & Geotechnical Report by Murray Engineers, Inc., dated February 10, 2014.

We note that submitted application materials indicate that future grading for residential development will not be significant, and this suggests that future houses will be constructed in a configuration stepped down existing site slopes. Relatively high cripple walls may be required beneath portions of future residences. If the visual mass of buildings built across steep slopes is a planning consideration, then illustrative architectural cross sections through conceptual buildings may assist with planning evaluations.

LIMITATIONS

This supplemental geologic and geotechnical peer review has been performed to provide technical advice to assist the County with its discretionary permit decisions.

Our services have been limited to review of the documents previously identified, and a visual review of the property. Our opinions and conclusions are made in accordance with generally accepted principles and practices of the geotechnical profession. This warranty is in lieu of all other warranties, either expressed or implied.

Respectfully submitted,

COTTON, SHIRES AND ASSOCIATES, INC.
COUNTY GEOLOGIC AND GEOTECHNICAL CONSULTANT

Ted Sayre
Principal Engineering Geologist
CEG 1795

David T. Schrier
Principal Geotechnical Engineer
GE 2334

TS:DTS:kc

December 4, 2014
G5164

TO: Erica Adams
Planner III
Planning and Building Department
455 County Center, 2nd Floor
Redwood City, California 94063

SUBJECT: **Geologic and Geotechnical Peer Review**
RE: Zmay Minor Subdivision and RMD Permit
PLN: 2014-00410
APN 038131110 (60.26 Acre Parcel)
1551 Crystal Springs Road, San Mateo County, California

We have completed a geotechnical peer review of the application for site subdivision using:

- Engineering Geologic & Geotechnical Investigation: 4-Lot Residential Development, Zmay Property (report) prepared by Murray Engineers, Inc., dated February 10, 2014; and
- Vesting Tentative Parcel Map (2 sheets, various scales) prepared by MacLeod and Associates, dated September 10, 2014.

In addition, we have reviewed pertinent technical maps, aerial photographs, and reports from our office files and completed a reconnaissance of the proposed upper lots.

DISCUSSION

The applicant proposes to subdivide the subject 60.26 acre parcel into four 2-acre lots with a 52.23 acre remainder parcel. Approximately 48.23 acres of the remainder is a proposed Conservation Easement/Open Space and 3.99 acres along Crystal Springs Road is to be excluded from the Conservation Easement and remain buildable. An existing residence is located on the subject 3.99 acres. We understand that this residence was approved for construction in 1984, and incorporated the design and construction of debris flow mitigation measures intended to protect the residence from potential debris flows.

line, it is important that slope stabilization measures be designed and constructed prior to individual lot residential development. We recommend that either consideration should be given to modifying property lines so that the entire landslide is within a single parcel, or that active landslide repair be proposed as a subdivision-level improvement.

Regarding proposed Parcel 4, we have not received verification that the currently delineated building envelope has been evaluated or approved by the Project Geotechnical Consultant who previously recommended that the building be shifted away from the ravine. Most of the building envelope is located on slope inclinations of 65 percent or greater. The proposed house site is beyond the norms of local geotechnical practice and is not consistent with the General Plan policy of avoiding construction on steeply sloping hillsides. We are also concerned with the presence of the precipitous ravine slopes below the building site and the potential for undermining the house site area over time. We conclude that sufficient information has not been presented to support geotechnical approval of the depicted building envelope on Parcel 4.

Regarding the designated remainder (48.23 acres), we note that slope and landslide conditions within this area could be unstable during wet winters and this may result in adverse offsite impacts to roadways and/or existing residences. We recommend that the Project Geotechnical Consultant evaluate landslides (and particularly debris flows) that may initiate within the 60.26 acre property and present adverse impacts to existing residential developments or roadways. A map should be prepared illustrating relative high risk areas and probable paths of debris transport. If unacceptable potential offsite impacts are identified, then appropriate geotechnical engineering mitigation options should be determined. It is particularly important that potential high risk areas within proposed new residential lots be identified and mitigated so that future new residential property owners do not assume significant liability for future potential offsite impacts.

We note that submitted application materials indicate that future grading for residential development will not be significant, and this suggests that future houses will be constructed in a configuration stepped down existing site slopes. Relatively high cripple walls may be required beneath portions of future residences. If the visual mass of buildings built across steep slopes is a planning consideration, then illustrative architectural cross sections through conceptual buildings may assist with planning evaluations.

2. Geotechnical Evaluation of Subdivision Plans - Future proposed subdivision plans should be evaluated and approved by the Project Geotechnical Consultant for conformance with recommendations prior to submittal of revised Tentative Map documentation to the County.

LIMITATIONS

This geotechnical peer review has been performed to provide technical advice to assist the County with its discretionary permit decisions. Our services have been limited to review of the documents previously identified, and a visual review of the property. Our opinions and conclusions are made in accordance with generally accepted principles and practices of the geotechnical profession. This warranty is in lieu of all other warranties, either expressed or implied.

Respectfully submitted,

COTTON, SHIRES AND ASSOCIATES, INC.
COUNTY GEOLOGIC AND GEOTECHNICAL CONSULTANT



Ted Sayre
Principal Engineering Geologist
CEG 1795

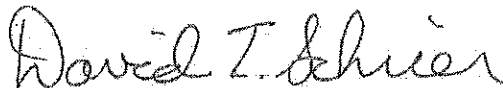

David T. Schrier
Principal Geotechnical Engineer
GE 2334

TS:DTS:kd



County of San Mateo - Planning and Building Department

ATTACHMENT N

<p>Recorded at the Request of, and When Recorded Return to: Camille Leung, Project Planner Planning and Building Department 455 County Center, 2nd Floor Mall Drop PLN122 Redwood City, CA 94063</p> <p>Exempt from Fees Pursuant to Government Code Section 27383</p>	<p>For Clerk Use Only</p>
---	---------------------------

County of San Mateo
Planning and Building Department

GRANT OF CONSERVATION EASEMENT

This GRANT DEED OF CONSERVATION EASEMENT is made on October ____, 2014, by Z ENTERPRISES LP, having an address at 1551 Crystal Springs Road, Hillsborough, CA 94010 ("Grantor") in favor of the COUNTY OF SAN MATEO having an address at County Government Center, 400 County Center, Redwood City, CA 94063 ("Grantee" or "County").

RECITALS

WHEREAS, Section 6317.A (Conservation Open Space Easement) of the San Mateo County Zoning Regulations (Zoning Regulations) requires, after any land division of lands zoned Resource Management (RM), that the applicant for the land division grant to the County (and that the County accept) a conservation easement, containing a covenant running with the land in perpetuity, which limits the use of the land covered by the easement to uses consistent with open space as defined in the California Open Space Lands Act of 1972 in January 1, 1980; and

WHEREAS, Grantor is the owner of lands located in the County of San Mateo, commonly referred to as the Lands of Zmay, the Vesting Tentative Parcel Map for which was approved by the San Mateo County Board of Supervisors on _____; and

WHEREAS, Grantor wishes to grant to Grantee a conservation easement over the property described in the attached Exhibit A (**description for the designated area for the proposed conservation easement/open space – 48.68 acres per Vesting Tentative Parcel Map**), which is incorporated herein by reference (the "Subject Property"), in fulfillment of the requirements of Section 6317.A of the Zoning Regulations.

NOW, THEREFORE, in consideration of the mutual covenants, terms, restrictions and conditions hereinafter set forth, Grantor hereby grants and conveys to Grantee and its

successors, a conservation easement, in gross and in perpetuity, on the terms, and subject to the limitations set forth herein.

Description of Property

1. Grantor is the sole owner of the Subject Property, located in the County of San Mateo, State of California and the Subject Property is the subject of this grant. The Subject Property is delineated on the Lands of Zmay Vesting Tentative Parcel Map and listed and described on Exhibit A, which is attached to and made part of this grant by reference.

Conservation Values

2. The Subject Property possesses natural, scenic, open space, habitat preservation, and recreational values which will be conserved through prevention of any future large scale residential development. In particular,
 - a. The preservation of the Subject Property is consistent with the General Plan of the County; and
 - b. The preservation of the Subject Property is in the best interest of the County and specifically because:
 - (1) The land is essentially unimproved and if retained in its natural state or improved for the limited permitted uses consistent with Section 9.e. below, has scenic value to the public and this instrument contains appropriate covenants to that end; and
 - (2) It is in the public interest that the Subject Property be retained as Open Space or improved for the limited permitted uses consistent with Section 9.e. below, because such land will add to the amenities of living in neighboring urbanized areas.
 - c. The preservation of the Subject Property is consistent with the Grantor's primary goal to maintain eligibility under the California Land Conservation Act of 1965 (also commonly referred to as the "Williamson Act.")

Intention of Grantor

3. It is the intention of Grantor to grant to Grantee a conservation easement on, over, across, and under the Subject Property pursuant to the Open Space Easement Act of 1974, appearing at Chapter 6.6 (commencing with Section 51070) of Part 1, Division 1, Title 5 of the California Government Code, and in fulfillment of the requirements of Section 6317.A of the San Mateo County Zoning Regulations whereby Grantor relinquishes certain rights and enters into certain covenants concerning the Subject Property, as more particularly set forth below. It is the intention of the Grantor that this grant meet all of the requirements of Section 170(h)(1) of the United States Internal Revenue Code, and meet all the requirements to maintain eligibility under the Williamson Act

Purpose of Easement

4. The purpose of this grant of an open space easement in the Subject Property is to preserve the natural and scenic character of the Subject Property, subject to the restrictions set forth herein, and to prevent any future large scale residential development of the Subject Property that will impair or interfere with the conservation values of the Subject Property. Grantor intends that this Conservation Easement will confine the use of the Subject Property to activities and improvements for the limited permitted uses consistent with Section 9.e. below.

Description of Grantee

5. Grantee is a political subdivision of the State of California, and is the entity designated under Section 6317.A of the San Mateo County Zoning Regulations to accept easements granted pursuant to that section.

Acceptance by Grantee

6. By accepting this grant, Grantee agrees to honor the intentions of Grantor to act in a manner consistent with the purposes of this grant, and to preserve and protect in perpetuity the conservation values of the Subject Property. Grantee shall accept this grant in satisfaction of Condition ____ to the approval by the Board of Supervisors on _____ and other related conditions of approval regarding a conservation easement. The effective date of this grant shall be the date that this grant of easement is recorded. In the event that any Parcel Map or the Final Subdivision Map is invalidated as a result of a legal challenge, this easement shall cease to have any effect and the Grantee shall reconvey to Grantor all rights it may hold by virtue of this easement and shall promptly record a quitclaim of all such rights. This grant satisfies the requirements in the County's Resource Management Zoning District for a subdivision under the Resource Management Zoning District.

Grant of Easement

7. In consideration of the above and the mutual covenants, terms, conditions, and restrictions contained in this grant deed, and pursuant to the laws of California and in particular to the Open Space Easement Act of 1974 and Section 6317.A of the San Mateo County Zoning Regulations, Grantor voluntarily grants to Grantee a conservation easement in gross in the Subject Property in perpetuity subject to the terms of this grant deed.

Covenants

8. The Subject Property shall be used by Grantor and Grantor's successors in interest only for those purposes that will maintain the existing open space character of the Subject Property. Any uses of the Subject Property shall further be limited to uses consistent with open space as defined in the California Open Space Lands Act of 1972, on January 1, 1980, as set forth in Government Code Section 65560. However,

Grantor and Grantor's successors in interest may improve the Subject Property consistent with Section 9.e. below.

Without limiting the generality of the foregoing, Grantor and Grantor's successors in interest hereby covenant that they will refrain, in perpetuity, from doing, causing, or permitting any of the following acts with respect to the Subject Property:

- a. Using or permitting the use of the Subject Property for any purpose except as is consistent with the stated purposes, terms, conditions, restrictions, and covenants of this easement, with the provisions of the Open Space Easement Act of 1974, and with the findings of the Board of Supervisors of the County of San Mateo pursuant to California Government Code Section 51084.
- b. Constructing improvements on the Subject Property. However, Grantor may construct and maintain existing utility, road and access easements or any such easements authorized or reserved by the Vesting Tentative Parcel Map for the Lands of Zmay approved by the Board of Supervisors of the County of San Mateo on _____, and make necessary improvements, including surfacing of the Subject Property, for the limited permitted uses consistent with Section 9.e. below, provided that any such construction and maintenance shall be carried out consistently with the conservation values that this Conservation Easement was intended to protect. This section is not intended to approve or otherwise legalize existing improvements constructed by any third person on the Subject Property, nor is to be construed as requiring that Grantor remove any such improvements that exist as of the effective date of this easement.
- c. Cutting or removing native timber or trees found or located on the Subject Property, except as may be required for fire prevention (but only as consistent with Section 9.b. below), thinning, elimination of diseased growth, or similar preventive measures in a manner compatible with the purposes of this grant, except as to the extent necessary for the limited permitted uses consistent with Section 9.e. below including harvest of planted trees.
- d. Cutting, uprooting, or removing natural growth found or located on the Subject Property, except as may be required for fire prevention (but only as consistent with Section 9.b. below), thinning, elimination of diseased growth, similar preventive measures in a manner compatible with the purposes of this grant, or to the extent necessary for the limited permitted uses consistent with Section 9.e. below including cleaning areas necessary for growing. Nothing in this Conservation Easement shall exempt Grantor from compliance with any regulations and/or permit requirements governing the removal of trees.
- e. Dividing or subdividing the Subject Property.
- f. If, during any time in which the Subject Property is owned by a public agency, and with respect to any activity that is otherwise permitted under the terms of this easement, this Section 8 shall not restrict Grantor from undertaking any such activity in any manner necessary in order to comply with the Americans With

Disabilities Act, Section 504 of the Rehabilitation Act of 1973 or any analogous state or federal laws.

Reservation of Rights

9. Grantor reserves the right to all uses and occupancy of, and ingress and egress to and from, the Subject Property in any manner consistent with the stated purposes, terms, conditions, restrictions, and covenants of this grant. Those uses include the following specific enumerated rights:

- a. The right to remove hazardous substances, rubbish, diseased plants or trees and to correct dangerous conditions on the Subject Property.
- b. The right to remove understory vegetation which, according to the County Fire Marshal, constitutes a fire hazard to the neighboring parcels. Nothing in this subsection of this Conservation Easement shall exempt the Grantor from compliance with regulations and/or permit requirements regarding the removal of trees.
- c. The right to repair underground utility lines.
- d. The right to post signs to deter trespass or to prevent, pursuant to Civil Code Section 1008, the creation of prescriptive easements, which signs shall be of no greater size than the minimum specified by law.
- e. The right to develop and improve the Subject Property for the following limited permitted uses:

- (i) – Agricultural uses and ^{limited} accessory structures, ^{temporary} on-site sales of agricultural products.
- ~~(ii)~~ – Nurseries and greenhouses.
- (iii) – Livestock raising and grazing.
- ~~(iv)~~ – Wineries; provided that the annual storage capacity shall not exceed 10,000 gallons, the annual fermentation capacity shall not exceed 5,000 gallons, and the annual bottling shall not exceed 2,500 cases of wine; the only retail sales permitted will be those of wines produced on the premises.

~~(v)~~ – Breweries including hop growing, fermentation, and production.

~~(vi)~~ – Animal fanciers.

~~(vii)~~ – Timber harvesting and commercial woodlots of planted trees.

~~(viii)~~ – Solar Panels. *when absent to an agricultural use*

Grantor's main goal is to maintain eligibility under the Williamson Act, therefore, any uses that would be interpreted by any governmental agency to be 1) prohibited by the Williamson Act or 2) increase the property tax due to the prohibition by the Williamson Act are excluded from the list of limited permitted uses above.

*No dumping
staying
outdoor storage*

- f. The right to construct structures considered to be accessory to the above permitted uses listed in Section 9.e. Nothing in this Conservation Easement shall exempt Grantor from compliance with any regulations and/or permit requirements governing the development and/or construction of the structures considered to be accessory to the above permitted uses.

Grantee's Approval

10. Whenever this grant deed requires Grantor to obtain the prior written approval or permission of the Grantee, the Grantor will notify the Grantee not less than fifteen (15) business days in advance of the date that Grantor intends to undertake the activity. The notice must describe the nature, scope, design, location, timetable, and any other material aspect of the proposed activity in sufficient detail to permit Grantee to make an informed judgment as to the consistency of the activity with the purpose of this grant. The Grantee shall grant or deny approval in writing within ten (10) business days of receipt of Grantor's notice. Grantee may deny approval only on a reasonable determination that the proposed action would be inconsistent with the purpose of this grant. The provisions of this Section 10 shall not apply during any time in which the Subject Property is owned by a public agency.

Right to Prevent Prohibited Use

11. Grantor grants to Grantee and Grantee's successors and assigns, for the duration of this grant, the right, but not the obligation, to prevent or prohibit any activity that is inconsistent with the stated purposes, terms, conditions, restrictions, or covenants of this grant and the right to enter the Subject Property for the purpose of removing any building, structure, improvement, or any material whatsoever constructed, placed, stored, deposited, or maintained on the Subject Property contrary to the stated purposes of this grant or to any term, condition, restriction, or covenant of this grant. By this grant, Grantor retains all rights to enforce the easement and any rights as an owner not inconsistent with this grant.

Enforcement

12. a. The purposes, terms, conditions, restrictions, and covenants in this grant may be specifically enforced or enjoined by proceedings in the Superior Court of the State of California, consistent with the terms of Section 51086 of the California Government Code.
12. b. It is understood and agreed that the enforcement proceedings provided in this section are not exclusive and that any action to enforce the terms and provisions of the Grant of Open Space Easement shall be at the discretion of Grantee and may be brought at law or in equity. Any forbearance on the part of Grantee to exercise its rights hereunder in the event of any breach hereof by Grantor, or by Grantor's heirs, successors, personal representatives or assigns shall not be deemed or construed to be a waiver of Grantee's rights hereunder in the event of any subsequent breach.

12. c. In any action by Grantee to enjoin any violation of this easement, Grantor agrees that Grantee shall have no obligation to prove either actual damages or the inadequacy of otherwise available legal remedies. Grantor agrees that Grantee's remedies at law for any violation of this easement are inadequate and that Grantee shall be entitled to the injunctive relief described in this section, both prohibitive and mandatory, in addition to such other relief to which Grantee may be entitled, including specific performance of this Conservation Easement, without the necessity of proving either actual damages or the inadequacy of otherwise available legal remedies. Grantee's remedies described in this section shall be cumulative and shall be in addition to all remedies now or hereafter existing at law or in equity. The failure of the Grantee to discover a violation shall not bar Grantee from taking action at a later time. The provisions of this Section 12.c. shall not apply during any time in which the Subject Property is owned by a public agency.

Acts Beyond Grantor's Control

13. Nothing contained in this instrument may be construed to entitle Grantee to bring any action against Grantor for any injury to or change in the Subject Property resulting from causes that are beyond Grantor's control, including, but not limited to, third party actions, trespass, fire, flood, storm, earth movement, or any prudent or reasonable action undertaken by Grantor in an emergency situation to prevent or mitigate damage or injury to the Subject Property resulting from such causes, provided that the emergency situation does not result from, or is not related to, actions undertaken by the Grantor. Nothing herein shall relieve Grantor of the obligation to apply for and obtain any required permits or approvals for any such actions.

No Authorization for Public Trespass

14. a. The granting of this Conservation Easement by this instrument and the acceptance of the easement by the Grantee do not, in themselves, authorize, and are not to be construed as authorizing, the public or any member of the public to enter, trespass on, or use all or any portion of the Subject Property, or as granting to the public or any member of the public any tangible rights in or to the Subject Property. It is understood that the purpose of this grant is solely to restrict the use of the Subject Property, so that it may be kept as near as possible in its natural state or the limited permitted uses consistent with Section 9.e.
14. b. It is the intention of Grantor and Grantee that should the fee simple interest in the Subject Property be transferred to a public agency or qualified non-profit entity or the County of San Mateo, passive recreational uses that preserve the natural open space character of the land may be allowed, including, but not limited to, nature walks, day hiking, picnicking, bird watching and photography. Any such future use would be subject to the approval of such subsequent owner.

Condemnation

15. As against the County of San Mateo, in its capacity as Grantee, the purposes of this Conservation Easement are presumed to be the highest and most necessary use of

the Subject Property as defined at Section 1240.680 of the California Code of Civil Procedure notwithstanding Sections 1240.690 and 1240.700 of that Code. If an action in eminent domain for condemnation of any interest in the Subject Property is filed, or if the Subject Property is acquired for a public improvement by a public agency or person, these restrictions will be null and void as to the interest in the Subject Property actually condemned or acquired. However, all conditions, restrictions, and covenants of this grant will be in effect during the pendency of such an action; if such an action is abandoned before the recordation of a final order of condemnation, any portion of the Subject Property that is not actually acquired for public use will once again be subject to all of the terms, conditions, restrictions, and covenants of this grant. Grantor will be entitled to the amount of compensation as if the Subject Property had not been burdened by the conservation easement, consistent with Section 51095 of the California Government Code. Nothing in this section shall preclude consideration of zoning as reflected in the approved Final Parcel Map.

Abandonment

16. The easement granted by this instrument may not be abandoned, in whole or in part, and Sections 51093 and 51094 of the California Government Code shall be inapplicable to this Conservation Easement.

Taxes and Assessments

17. Grantor or Grantor's successor or assigns shall pay or cause to be paid all real property taxes and other assessments (general and special), fees, and charges of whatever description levied or assessed against the Subject Property. Grantee agrees to cooperate with Grantor in documenting the existence and property tax-related effect of the easement for the Assessor of San Mateo County. The provisions of this Section 17 shall not apply during any time in which the Subject Property is owned by a public agency.

Maintenance

18. The Grantee shall not be obligated to maintain, improve or otherwise expend any funds in connection with the use or enjoyment of Subject Property or any interest created by this Grant of Easement.

Liability and Indemnification

19. a. Grantor retains all responsibility and shall bear all costs and liabilities of any kind related to the ownership, operation, upkeep, and maintenance of the Subject Property. Grantor agrees that the Grantee shall not have any duty or responsibility for the operation, upkeep, or maintenance of the Subject Property, or the protection of Grantor, the public or any other third parties from risks related to the condition of the Subject Property. Grantor shall remain solely responsible for obtaining any applicable governmental permits and approvals required for any activity or use by Grantor permitted by this easement, including permits and approvals required from Grantee acting in its regulatory capacity and any activity or use shall be undertaken in accordance with all applicable federal, state, local,

and administrative agency laws, statutes, ordinances, rules, regulations, orders, and requirements. Acceptance of this Grant of Open Space Easement by Grantee is subject to the express condition that the Grantee and its officers, agents, members and employees are to be free from all liability and claim for damage by reason of any injury to any person or persons, including Grantor, or property of any kind whatsoever and to whomsoever belonging, including Grantor, resulting from any pre-existing condition(s) on the Subject Property, and any acts or omissions of the Grantor or Grantor's predecessors or successors in interest related to the Subject Property. Grantor, on its behalf and on behalf of its successors in interest, hereby covenants and agrees to indemnify and hold harmless the Grantee, and its directors, officers, employees, agents, contractors, and representatives, and their respective heirs, personal representatives, successors, and assigns (each, an "Indemnified Party") from and against any and all liabilities, penalties, costs, losses, damages, expenses (including, without limitation, reasonable attorney(s) fees and other litigation expenses), causes of actions, claims, demands, orders, liens, or judgments (each, a "Claim") on account of or arising out of any pre-existing condition(s) on the Subject Property and any acts or omissions of the Grantor or Grantor's predecessors or successors in interest related to the Subject Property, except that this indemnification obligation shall be inapplicable to any Claim determined to result solely from the negligence of Grantee or any of its agents.

If any action or proceeding is brought against any of the Indemnified Parties by reason of any such Claim, Grantor and its successors in interest shall, at the election of and upon written notice of any such Indemnified Party, defend such action or proceeding by counsel reasonably acceptable to the Grantee's Indemnified Party or reimburse such Indemnified Party for all charges incurred for services of any government attorney (including, but not limited, for example, to attorneys of the Office of the County Counsel) in defending the action or proceeding. Grantee agrees that, in the defense of any such Claim, it will vigorously assert all existing and applicable immunities and defenses.

- b. The Grantee shall have no right of control over, nor duties and responsibilities with respect to, the Subject Property, which would subject the Grantee to liability occurring on the land, by virtue of the fact that the right of Grantee to enter the land is strictly limited to preventing uses inconsistent with the interests granted, and does not include the right or obligation to enter the land for the purposes of correcting any dangerous condition as defined by California Government Code Section 830.
- c. Grantor agrees to maintain bodily injury and property damage liability insurance as shall protect it from claims related to conditions on the Subject Property and to name the Indemnified Parties as additional insureds on such policies.
- d. The provisions of subsections 19.a. and 19.c. of this Section 19 shall not apply during any time in which the Subject Property is owned by a public agency.

Amendment

20. This Conservation Easement may not be amended in whole or in part as to any term, condition, restriction, or covenant without the prior written consent of the Grantor and Grantee. During all times that the County of San Mateo remains owner of this easement, any non-clerical amendment to this easement that is proposed shall be presented at a duly-noticed public meeting of the San Mateo County Planning Commission for a recommendation of the Planning Commission before the proposed amendment is presented to the San Mateo County Board of Supervisors for action.

In the event that another public agency besides the County of San Mateo becomes the owner of this easement, that public agency shall convene a public hearing before its governing board to consider any proposed amendments to this easement before the governing board approves any such proposed amendments. Notwithstanding the foregoing, in no event shall any amendment to this Conservation Easement be permitted which violates the California Open Space Lands Act or which contradicts the perpetual nature of this easement.

Binding on Successors and Assigns

21. This grant, and each and every term, condition, restriction, and covenant of this grant, is intended for the benefit of the public and is enforceable pursuant to the provisions of the Open Space Easement Act of 1974. This grant binds Grantor and Grantor's successors and assigns and constitutes a servitude on the Subject Property that runs with the land.

Liberal Construction

22. This easement is to be liberally construed in favor of the grant in order to effectuate the purposes of the easement and the policy and purpose of the Open Space Act of 1974. If any provision in this grant is found to be ambiguous, an interpretation consistent with the purpose of this easement that would render the provision valid will be adopted over any interpretation that would render it invalid.

Severability

23. If any provision of this grant is found to be invalid, or if the application of this easement to any person or circumstance is disallowed or found to be invalid, the remainder of the provisions of the grant, or the application of the grant to persons or circumstances other than those to which its application was disallowed or found invalid, will not be affected and will remain in full force and effect.

Controlling Law

24. This grant of easement is to be interpreted, enforced, and performed in accordance with the laws of the State of California.

Entire Agreement

25. This grant sets forth the entire agreement of the parties with respect to the conservation easement and supersedes all previous conversations, negotiations, understandings, settlements, or agreements related to the conservation easement.

Captions

26. The captions in this grant have been inserted solely for the purpose of convenience of reference and are not to be construed as part of this instrument and do not affect the construction or interpretation of the grant.

Enforceable Restriction

27. This easement is intended to constitute an enforceable restriction pursuant to the provisions of California Constitution, Article XIII, Section 8, and Sections 402.1 and 421 through 423.3 of the California Revenue and Taxation Code.

Counterparts

28. The parties may execute this instrument in two or more counterparts, which shall, collectively, be signed by all parties. Each counterpart shall be deemed an original instrument as against any party who has signed it. In the event of any disparity between the counterparts produced, the recorded counterpart controls.

Recording

29. Grantee shall record this Conservation Easement in the Office of the County Recorder of the County of San Mateo and may re-record it at any time that Grantee deems it necessary in order to preserve its rights in this easement.

Merger

30. It is the intent of the Grantor and the Grantee that the doctrine of merger not operate to extinguish this Conservation Easement if the same person or entity comes to own both the easement and the Subject Property. If, despite this stated intention, the doctrine of merger is determined to have extinguished this Conservation Easement, then a replacement conservation easement or restrictive covenant containing the same material protections embodied in this Conservation Easement shall be prepared and recorded against the Subject Property.

IN WITNESS WHEREOF, Grantor has executed this Conservation Easement Deed the day and year first written above.

Dated: _____

_____, GRANTOR
Z ENTERPRISES LP
By: Steve Zmay

ACCEPTANCE OF CONSERVATION EASEMENT

Pursuant to the provisions of the Open Space Easement Act of 1974, appearing at Chapter 6.6 of Part 1, Division 1, Title 5 of the California Government Code (commencing with Section 51070), the County of San Mateo accepts this grant of a conservation easement.

Dated: _____

COUNTY OF SAN MATEO

By: _____



County of San Mateo - Planning and Building Department

ATTACHMENT O

CULTURAL RESOURCES SURVEY REPORT

1551 Crystal Springs Road

Hillsborough, San Mateo County

APN 038-131-110

Prepared by
Daniel Shoup, RPA
Archaeological/Historical Consultants
609 Aileen Street, Oakland, CA 94609

Prepared for
Nick Zmay
1551 Crystal Springs Road
Hillsborough, CA 94010-7274

USGS San Mateo 7.5' Quadrangle

August 10, 2015

Table of Contents

EXECUTIVE SUMMARY	2
PROJECT LOCATION AND DESCRIPTION	3
Previous Studies and Archival Research	5
Native American Consultation.....	5
BACKGROUND	6
Environment.....	6
Prehistory	6
Ethnography	7
History.....	8
Land Use in the Project Area	11
Field Methods and Findings	13
Survey Methods and Constraints	13
Survey Results: Archaeological Resources	13
Survey Results: Built Environment Resources.....	13
SIGNIFICANCE EVALUATION AND CONCLUSIONS	15
Framework for Evaluation	15
Significance Evaluation and Recommendations.....	16
BIBLIOGRAPHY	17

EXECUTIVE SUMMARY

Nick and Steve Zmay propose to subdivide four lots measuring a total of 3 acres from their 60-acre property at 1551 Crystal Springs Road, unincorporated San Mateo County, California. To secure a negative declaration under CEQA, San Mateo County has requested a cultural resources evaluation of the area proposed for subdivision.

Daniel Shoup of Archaeological/Historical Consultants (A/HC) conducted an archaeological field survey on July 28, 2015. Dr. Shoup is a Registered Professional Archaeologist, holds a Ph.D. in Archaeology and a Masters of Urban Planning, and has over 5 years of experience in California archaeology. He meets the Secretary of the Interior's Standards for Archaeology.

No prehistoric or historic cultural resources were discovered during the survey.

PROJECT LOCATION AND DESCRIPTION

The proposed project involves subdivision of four lots measuring approximately 0.75 acres each from the existing 60-acre parcel at 1551 Crystal Springs Road (APN 038-131-110). The four lots, which total 3 acres, front on Parrott Drive and will be the locations of new single-family residences (see Maps 1 and 2).

The Area of Potential Effects for the project includes the four lots and a small area (0.25 acres) of slope repair, totaling 3.25 acres more or less. The remaining 57 acres of APN 038-131-110 remain outside the scope of the current study.

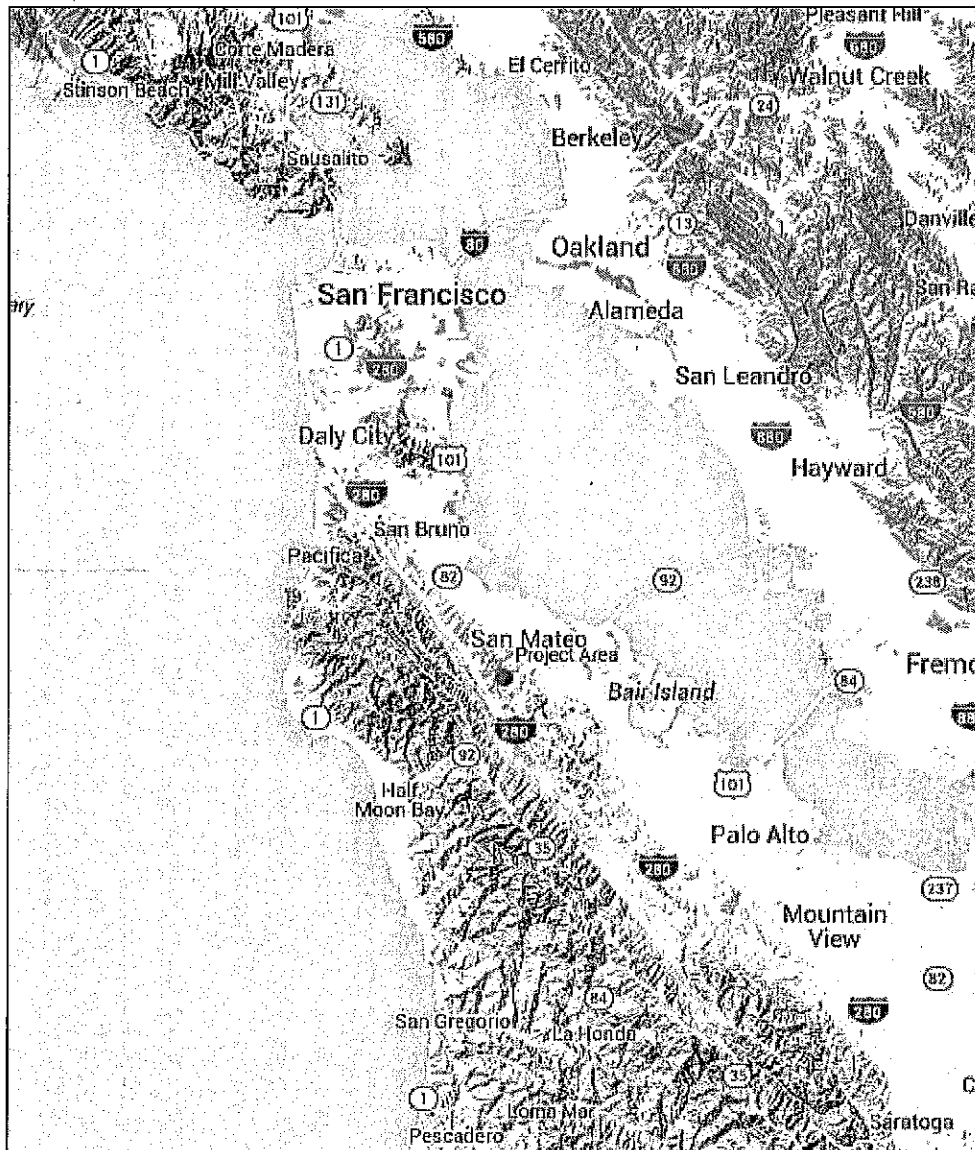

Figure 1: Project Location

Imagery Google

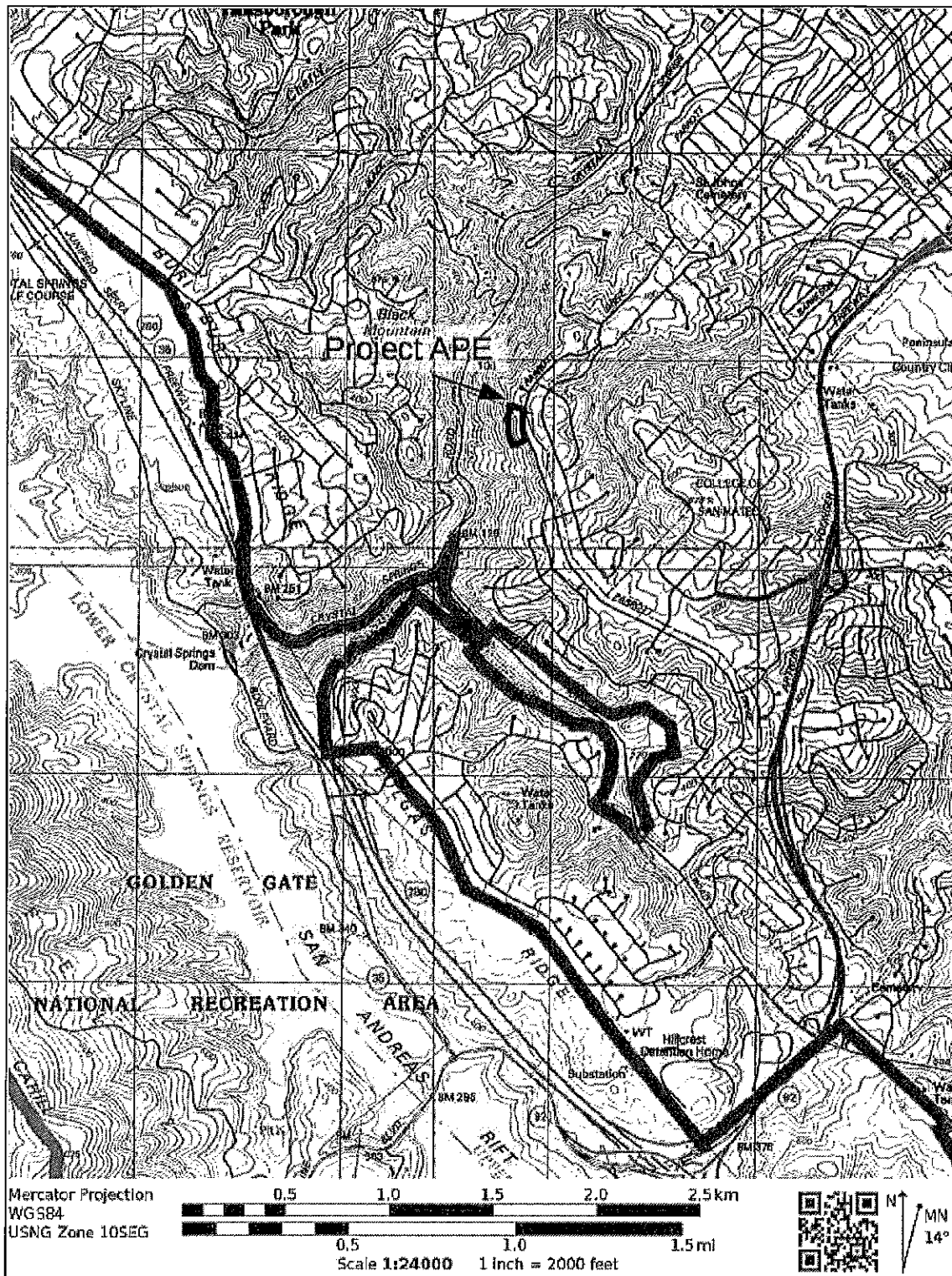

Figure 2: Project Vicinity, showing APE

Imagery USGS/CalTopo

SOURCES CONSULTED

Previous Studies and Archival Research

In July 2015 a record search for previously recorded cultural resources in the project area and within a half-mile radius was conducted at the Northwest Information Center, California Historical Resources Information System (NWIC File #14-1853). No cultural resources are recorded within the project area. Two previous reports discuss the project area in a general way but did not include field survey of the current project APE (see Appendix A).

A/HC staff also reviewed the National Register of Historic Places, the California Register of Historic Resources, California Historical Landmarks, and the California Inventory of Historical Resources to determine whether any previously recorded cultural resources exist within the project area. In the scope of that review, none were found. Archival research was conducted at the Earth Sciences and Map Library, University of California Berkeley, historic City Directories and newspaper archives for San Mateo County, and at the Online Archive of California. For a full list of sources consulted, see the attached bibliography.

Native American Consultation

On July 27, 2015 the California Native American Heritage Commission (NAHC) in Sacramento was contacted to determine whether it had any information about archaeological sites or traditional cultural properties of concern to Native Americans in the project area. No response had been received by August 10, 2015.

Letters to the eight individuals and organizations on the NAHC contact list for San Mateo County were sent on July 27, 2015 via email and U.S. Mail.

Michelle Zimmer of the Amah Mutsun Tribal Band replied on July 28, 2015, noting that Native American human remains had been recently found near the project area during trenching for the El Cerrito Sewer Project on Crystal Springs Road. She offered three recommendations:

- That all excavation crews, including landscapers, receive cultural sensitivity training for Native American cultural resources;
- That a California-trained Archaeological Monitor with field experience be present for all earth movement including landscaping; and
- That a qualified and trained Native American Monitor be present for all earth-moving activities, including landscaping.

No other replies were received by August 10, 2015.

See Appendix B for correspondence with NWIC, NAHC, and Native American contacts.

BACKGROUND

Environment

The project area lies between approximately 400' and 500' in elevation on steep, north-facing slopes above San Mateo Creek, which drains eastward into San Francisco Bay. Site soils are tan silty clays or clayey silts with large chunks of decomposed bedrock. The underlying geology of the ridge is Franciscan Complex mélangé, composed of mixed volcanic, metamorphic, and sedimentary rock and dating to the Eocene, Paleocene, or late Cretaceous periods (Graymer et al. 2006). The property is located within a mile of the San Andreas Rift Zone. The vegetation community on the property is a mix of California chaparral and oak woodland, including Coast Live oak, scrub oak, manzanita, chamise, sage, tule, Poison Oak and Ceanothus.

Prehistory

Early archaeological research in the San Francisco Bay area focused on the largest and most visible remnants of prehistoric settlements, the hundreds of shellmounds ringing the Bay (Nelson 1909). The implementation of CEQA and NEPA regulations in the 1970s, however, led to dramatic increases in archaeological research throughout the Bay Area (Moratto 1984:227; Milliken et al. 2007:106). Based on evidence from mortuary practices in the Sacramento Delta and San Francisco Bay areas, the Central California Taxonomic System (CCTS) was developed, dividing the prehistory of the region into Early, Middle, and Late periods. While other systems have sought to add subtlety to the CCTS (e.g. Fredrickson 1974), most South Bay archaeologists use a version of the CCTS. Here we present a summary of Hylkema's (2002) and Milliken *et al.*'s (2007) adaptations of the Early-Middle-Late system.

Little evidence of Upper and Lower Archaic (pre-6000 years BP) settlement is known from the San Francisco Bay Area; in other parts of California this period is characterized by mobile foragers using wide-stemmed and leaf-shaped projectile points and large milling slabs (Milliken *et al.* 2007:112). Given the rise in sea levels in the Middle Holocene, the relatively recent formation of San Francisco Bay, and the presence of constant alluviation in the low-lying areas of the Bay Area, most evidence of the earliest human habitation in the area is likely to be underwater or deeply buried. However, deep deposits from the Coyote Narrows (CA-SCI-178) in Morgan Hill have yielded radiocarbon dates of 10000-8500 years BP associated with flaked tools of local Franciscan chert (Jones et al. 2007:130).

The Early (or Windmill) pattern (4000-2500 BP) is characterized by large stemmed and concave-base obsidian projectile points, rectangular *Olivella* beads, charmstones, extended burials facing toward the west, and the replacement of milling slabs with mortars and pestles. Semi-sedentary land use, shell mound development, and evidence of regional trade are typical in some areas of the Bay. This cultural pattern appears earlier in the San Joaquin and Sacramento valleys, suggesting an influx of traditions or people from those areas into the Bay Area.

Within the Middle Period (or Berkeley Pattern, 2500-1300 BP), upper and lower subphases can be distinguished. The Lower Middle Period 2500-1700 BP is marked by major cultural disruptions, such as the disappearance of the square *Olivella* bead tradition and the introduction of new bead types, much lower frequency of projectile points, introduction of flexed burials, and introduction of decorative objects that may represent religious or cosmological beliefs. In the

Upper Middle Period (1700-1300 BP), another major cultural shift seems to have taken place, with the collapse of trade networks, site abandonment, and the introduction of new bead forms. In the South Bay, a distinct local tradition known as the Meganos culture emerged during the Middle Period, possibly marking a population movement from the San Joaquin Valley.

The last millennium before contact with the Spanish is characterized as the Augustine Pattern (1300-250 BP), divided by Hylkema (2002) into three subphases: the Middle/Late Transition period and Late Period Phases 1 and 2. The Middle/Late transition saw the emergence of a wider range of social stratification. In the Late periods, significant social transformations seem to have occurred, with an increase in social complexity, increased sedentism, and the unification of ceremonial systems around the Bay Area. The introduction of the bow and arrow led to the production of new types of arrow-sized projectile points, cremation of high status individuals reappeared, and new forms of ornamentation such as the *Haliotis* 'banjo' effigy ornaments became more popular. The last two centuries before Spanish contact saw a series of changes in shell bead types, mortuary wealth distribution, and the introduction of new technology types such as the hopper mortar in parts of the Bay Area, though some of these innovations were slow to arrive in San Mateo County (Milliken *et al.* 2007:117).

Ethnography

Prior to 1770, the San Francisco peninsula, was inhabited by speakers of the Ohlone/Costanoan group of languages, which despite significant dialectical differences (Levy 1978) were likely mutually intelligible (Milliken 1995:26). Ohlone/Costanoan, which is closely related to the Miwok languages, is a branch of the Yok-Utian subfamily of the Penutian languages, which are spoken in Central California and along the Pacific Coast as far as southeast Alaska. Penutian speakers likely entered central California from the northern Great Basin around 4000-4500 years ago and arrived in the San Francisco Bay Area about 1500 years ago, displacing speakers of Hokan languages (Golla 2007:74). This movement may be correlated with the spread of the Windmill pattern of material culture into the Coast Ranges and San Francisco Bay area (Moratto 1984:553; Levy 1978:486).

Ohlone/Costanoan society was organized in independent tribelets of 200-400 people, living in several semi-permanent villages, that controlled fixed territories averaging 10 to 12 miles in diameter (Milliken *et al.* 2007). Shoup and Milliken (1999:8) note that "tribelets were clusters of unrelated family groups that formed cooperative communities for ceremonial festivals, for group harvesting efforts, and – most importantly – for interfamily conflict resolution." Hereditary village leaders, who could be male or female, played an important role in conflict resolution, receiving guests, directing ceremonies, organizing food-gathering expeditions, and leading war parties but did not otherwise exercise direct authority (Levy 1978:487). Despite their autonomy, intermarriage between Costanoan tribelets appears to have been frequent (Milliken 1995:22-24).

Like most California peoples, acorns were a staple of Ohlone/Costanoan diet. They were supplemented with other plant foods such as berries, onions and other root vegetables, and herbs. For animal resources people looked both to the Bay for fish, shellfish, waterfowl, and sea mammals, and to the plains and hills for larger animals such as deer and elk (Milliken *et al.* 2007:105-106).

At the time of Spanish contact, the Ssalon tribelet occupied land between the San Andreas Valley and the bay shore. Mission records list the villages of Altagmu, Aleitac, and Uturbe as located

along branches of San Mateo Creek, though their exact locations are unknown. The Ssalon were a small- to medium-sized tribelet: a total of 173 Ssalon people were baptized at mission Dolores, most of them between 1780 and 1793 (Milliken 1995:255, Milliken et al. 2009:313).

History

The Crystal Springs area is significant for its role as an early route used by Spanish explorers and colonists in their efforts to establish control over coastal California and the San Francisco Bay Area. In 1769, the first overland expedition by Europeans reached the San Francisco Peninsula. Led by Gaspar de Portola, who had been appointed Governor of the new province of California, the expedition was intended to assert Spanish control over upper California by establishing a Presidio at Monterey Bay. The expedition consisted of 64 men, including 27 soldiers, two priests, and fifteen Native American Christians from the missions of lower California (Eldredge 1909:29).

Portola's expedition departed San Diego on July 14, 1769. Confused by the rugged terrain, the party passed Monterey Bay and proceeded into the Santa Cruz Mountains, reaching the San Francisco Peninsula in late October. As they reached the San Pedro Valley, the party spotted the Farallon Islands and realized that they had come too far north. After men dispatched to hunt game reported the presence of a giant estuary to the east, the entire expedition climbed Sweeney Ridge on November 4, marking the European discovery of San Francisco Bay. Miguel Constanso, the party's engineer, reported that that evening the party descended the ridge into the valley below, now beneath the San Andreas Reservoir (Babal 1990:8-9). On November 6, the Portola expedition moved south-southeast along the valley into the project area. Crespi describes the area now covered by Crystal Springs Reservoir:

We traveled in a southerly direction along the edge of the estuary (San Francisco Bay), but without seeing it, as we were prevented by the hills of the valley which we were following. On the right hand we had delightful mountains, with many groves of live oaks and redwoods. We... halted near a lake formed by an arroyo of good water with unlimited pasture and numberless geese in the same valley, in which there have been seen many tracks of large animals (Bolton 1927:232).

Their campsite the night of November 6, 1769 was about two miles south of the project area, near the current alignment of Upper Crystal Springs Dam and Highway 92. A party of scouts spent four days exploring the east shore of the Bay before returning to San Diego in January 1770 (Babal 1990:11).

Mission San Francisco (1776-1833)

In 1776, Juan Bautista de Anza led a group of settlers to establish the mission at San Francisco. His advance party of soldiers, led by José Moraga, camped along San Mateo Creek, just north of the project area (Babal 1990:12). The establishment of a mission system by Franciscan priests in Alta California was part of a strategic effort to extend Spanish power to Alta California against an ongoing Russian advance down the Pacific Coast. The missions, supported with small military detachments, were to convert local Native Americans and establish agricultural plantations using their labor (Shoup and Milliken 1999:17).

After the establishment of Mission San Francisco in 1776, the lands of the San Francisco Peninsula came under control of the church. In the San Pedro Valley, west of the project area, an agricultural and ranching outpost was established in 1786 on a former indigenous village site.

Such enterprises were operated by Native American “neophytes”, who were brought to the missions through a mixture of choice, persuasion, and force. Missionized Indians received instruction in Christianity and were compelled to work at agricultural tasks that must have appeared strange to them; more difficult was the loss of personal freedoms, physical brutality, and imposition of Catholic sexual mores (Milliken 1995:88). The resulting mission system was a combination of feudal religious commune and slavery. European diseases ran rampant, with death tolls reaching 8% per year, higher among women and children, and Mission livestock grazing began to degrade the local environment, impacting the availability of traditional food resources for those Native Americans who remained outside the Mission system; by 1810 traditional cultures were collapsing throughout coastal and central California (Milliken 1995:221).

Poor working conditions and lack of resistance to European diseases led to frequent epidemics, which struck the San Pedro settlement in 1791 and led to its abandonment soon thereafter. A new outpost was built on San Mateo Creek, north of the project area, in 1793. It is likely that throughout the Mission period, the project area was used primarily for pasturing the large herds of cattle and sheep owned by the Presidio and the Mission, which were tended by Missionized Ohlone and other Native Americans (Hynding 1982:19, 22).

Land Grants in the Mexican Period (1822-1848)

After independence from Spain in 1821, the Mission system went into terminal decline. In a climate of increasing immigration from Mexico and increasing population of Mexican *Californios*, the missions were secularized and much of their land confiscated between 1834 and 1837 (Shoup and Milliken 1999:109). In turn, large land grants were distributed to prominent Mexican citizens. Four of these were located in the Crystal Springs area: Ranchos Feliz and Cañada Raymundo to the west, and Ranchos San Mateo, Buri Buri and Las Pulgas to the east (Beck and Haase 1988:30).

Rancho de las Pulgas, where the project APE is located, was the largest and oldest of these. A 1795 verbal grant to Jose Arguello, a former commander of the San Francisco Presidio, was confirmed to his heirs in 1820, making it the only grant in the area conferred under Spanish Rule. The 35,000 acre rancho stretched from the Bay estuary to the Crystal Springs Reservoir Valley, and from San Mateo Creek in the north to the Santa Clara county line in the south (Stanger 1938:40). The Arguello family was prominent in the government of California up to the American takeover, and lived mostly in San Francisco and Monterey. For this reason, and because they had large landholdings elsewhere, few improvements were made to Las Pulgas beyond a few huts for shepherds (Hynding 1982:36). In the Mexican period it is likely that the project area continued to be used as grazing land.

The Early American Period (1849-1870s)

The trickle of Anglo-American immigrants to California during the mid-1840s became a flood after the two key events in early 1848. These were the Treaty of Guadalupe Hidalgo, which ceded California to the United States, and John Marshall’s discovery of gold on the South Fork of the American River. The subsequent gold rush of 1849 brought tens of thousands of people, mostly men, to the Bay Area. Many who did not find success in the gold fields decided to appropriate what they saw as empty land on ranchos around the Bay (ESA 1994:6-11). On Rancho de las Pulgas, for instance, at least twenty-three squatters were occupying land in 1853 (Hynding 1984:37). Mexican landowners such as the Arguellos were faced with a new legal

system that took an average of seventeen years to resolve claims. During the long legal process, many landowners were forced to sell off portions of their land to pay legal fees. Only one Mexican landowner, Domingo Feliz, was able to retain property in the mid-peninsula area (Babal 1990:44, 58).

From the 1850s to the 1887 beginning of the construction of Lower Crystal Springs Dam, the Crystal Springs Valley and its surroundings were home to a community of farmers, loggers, tradesmen that also contained summer homes owned by wealthy urbanites. Homesteads in the area spread out along the north-south road from San Andreas to Cañada Raymundo (the earlier name for the southern end of Crystal Springs Valley, now under the Upper Crystal Springs Dam). Logging of oak and redwood in the Peninsula began as early as the 1830s, and accelerated after 1849, when dozens of small water or steam-powered sawmills were established along peninsula creeks. The valley of San Mateo Creek, just below the project area, was an early transportation corridor in the area: the predecessor to today's Crystal Springs Road was graded through the canyon by the mid-1850s, connecting Burlingame and Half Moon Bay.

A frequent visitor described the Cañada del Raymundo in the 1860s:

To the north were fine farms and country estates... To the south was a long stretch of hayfields and pastures in which dairy herds grazed... Twice a day the stage rattled in, changed horses, and rattled out again, once on its way to Half Moon Bay and again on the return to San Mateo. It was a restful, hospitable, shut-in sort of place, beautiful in its setting among the hills (Burke 1926).

As the quote above suggests the Cañada Raymundo was primarily occupied by dairy farms. On the east shore of Laguna Grande, the small lake along Laguna Creek now under the Upper Crystal Springs Reservoir, Christian Bollinger established a dairy farm after his arrival in San Mateo County in 1854. He owned 628 acres in 1868, but expanded enough that he could sell 1,100 acres to Spring Valley Water Company in 1874. Bollinger's dairy products were sold in San Francisco, most notably to the Palace Hotel (Babal 1990:60).

The rustic setting of the Crystal Springs Valley, home of country homes and profitable ranches, was short-lived. By the mid-1860s, the Spring Valley Water Company had begun to acquire land on a large scale, a development that would soon replace the pastoral character of the area with large reservoirs.

Spring Valley Water Company

As the population of San Francisco grew, reliable water supply to the arid city became an important concern. Reliance on groundwater, the small local creeks, and imports of water in barrels from Marin County proved inadequate by the late 1850s. In 1858, a group of San Francisco businessmen formed Spring Valley Water Company and began acquiring land to build reservoirs in the steep valleys of northern San Mateo County (ESA 1994:6-15). Spring Valley's first dams, constructed before 1870, were at Pilarcitos Creek and the San Andreas Valley (Babal 1990:30).

Spring Valley Water was aware of the Crystal Springs Valley's potential as a reservoir site as early as the 1860s, when the Company purchased the Crystal Springs Hotel to secure its land and the water rights to San Mateo Creek. Through the 1860s and early 1870s, agents of the company began to acquire the whole of Crystal Springs Canyon and the upper reaches of San Mateo Creek, often under their own names to mask company involvement. To assemble the final

parcels needed for the construction of the dams, Spring Valley also persuaded the San Mateo Board of Supervisors to use their power of condemnation (Hynding 1982:75). By the mid-1870s, Spring Valley had acquired enough land – including the project APE – to begin construction of the Upper Crystal Springs Dam, which was 70 feet high and 520 feet wide when completed in 1876 and stretched across the valley along the current alignment of Highway 92 (Babal 1990:91).

Continuing growth in San Francisco's demand for water led engineer Hermann Schussler to design a second dam in the valley, this one to stretch across San Mateo Creek at the point where it turned east and flowed down out of the Crystal Springs/San Andreas Valley. The Lower Crystal Springs Dam was architecturally innovative: at 145 feet high, it was the largest concrete dam in the United States at the time (Shoup 1989:5). When completed in 1890, the dam impounded 22 billion gallons of water over 1,483 acres. The water was pumped to San Francisco via a 44-inch pipeline that followed the Bay shore (Shoup 1989:9; Babal 1990:95). Since the new dam flooded the San Mateo-Half Moon Bay highway that had passed through Crystal Springs, the level of Upper Crystal Springs Dam was later raised 20 feet to serve as a replacement bed for the county road.

The construction of Lower Crystal Springs Dam was a stirring success from Spring Valley Water Company's point of view, but did not solve its growing problems with the City of San Francisco which resented Spring Valley's monopoly control of its water supply. The city filed a series of suits over water rates, and adopted a city charter that allowed for municipal ownership of the water system (Babal 1990:42, Stanger 1938:185). A city commission turned to the Sierra Nevada for potential reservoir sites, and identified the Hetch Hetchy Valley on the Tuolumne River as their preferred site. After the passage of the 1913 Raker act over the objections of environmentalists, San Francisco was allowed to begin planning the Hetchy Hetchy reservoir (Babal 1990:42).

The completion of the Hetchy Hetchy Dam in 1924 took away not just Spring Valley's monopoly power, but its only market. As a result, in 1930 the City of San Francisco purchased Spring Valley's watershed lands, including the project APE, and placed them under the administration of the newly formed San Francisco Water Department. Crystal Springs Reservoir was selected to be the terminus of the pipeline system that brought water from the Sierra Nevada, across the central valley, and under San Francisco Bay. The first Hetchy Hetchy water began flowing into Crystal Springs Reservoir on October 24, 1934 (ESA 1994: 6-15). To memorialize the event, a Classically-inspired temple was constructed in 1938. Sixty feet high and 25 feet in diameter, the Pulgas Water Temple stands above a weir that was the original terminus of the Hetch Hetchy Aqueduct (Babal 1990:107). This terminus is no longer in use, as Hetchy Hetchy water now flows directly to San Francisco without entering the Crystal Springs Reservoirs.

Land Use in the Project Area

Though the canyon of San Mateo Creek was long used a transportation and resource corridor by Native Americans, it was not until 1860 that a portion of the County Road connecting San Mateo to Half Moon Bay was constructed through the canyon (ESA 1994:6-14). West of the project area, this road intersected a local route that passed north-south through Crystal Springs valley. Daily stagecoach service on the County Road was provided by 1865 by the San Mateo, Pescadero, and Santa Cruz Stage Company, which stopped at Crystal Springs, San Feliz Station,

and Brynes Store, all within two miles of the project vicinity. The road was improved in 1866 by local contractor Bowman and a crew of Chinese-American workers (Babal 1990:25).

The project area was part of lands acquired by Spring Valley Water Company in the late 1860s and early 1870s; the project area was at the eastern boundary of SVWC's property in San Mateo Creek canyon. In 1894, the project area was bounded to the north by the lands of A.M. Parrott (for whom Parrott Road is named) and to the east by the lands of W.S. Hobart (Bromfield 1894). The project area was owned by SVWC until at least 1927 (Kneese 1927).

Parrott Drive began as a dirt road, which is shown as such on USGS maps from 1939 to 1949. The road was paved around 1950, followed by the creation of the Baywood Park subdivision in 1952. The five houses east of the project area across Parrott Road were all constructed in 1952. The homes north of the project area along the west side of Parrott Road were constructed in the mid-1980s (San Mateo County 2015).

After acquisition of SVWC by the City and County of San Francisco in 1930, the project area passed into private hands. The Zmay family purchased the property around 1975 and continues to own it today.

FIELD METHODS AND FINDINGS

Survey Methods and Constraints

The four parcels proposed for subdivision are located on a north-facing ridge descending from 500' elevation at Parrott Road to approximately 400' elevation. The average slope across the APE is 40%. Visible soils are tan to dark tan sandy clay with 2-20cm angular cobbles 10% by volume. In several locations small outcrops of metamorphosed sedimentary bedrock are visible. The APE is vegetated in low grass, mature coast live oak, and dense thickets of chamise, Ceanothus, scrub oak, poison oak, and tule, in some areas reaching heights of 8 feet.

Dr. Daniel Shoup of Archaeological/Historical Consultants carried out a pedestrian archaeological survey of the APE on July 28, 2015. Dr. Shoup meets the Secretary of the Interior's Standards for archaeology. All open areas were inspected for cultural evidence such as historic structures, artifacts, and features; and indicators of prehistoric archaeological deposits like midden soil, flaked lithics, groundstone, and shell.

Given the irregular nature of the terrain and presence of dense vegetation, opportunistic transects were used, spaced roughly 10m apart. Certain areas of the APE were impassible: the upper parts of Lots 2 and 3 due to brush, the lower portions of Lot 2 due to tule thickets reaching 8' high, and portions of Lots 3 and 4 due to slopes exceeding 60% or poison oak thickets 6'-8' in height. Areas surveyed are indicated on Figure 3 and total 2 acres of the 3.1 acre APE (65%). Approximately 90% of Lot 1, 40% of Lot 2, 75% of Lot 3, and 60% of Lot 4 were surveyed in at least 10m transects.

Survey Results: Archaeological Resources

No prehistoric archaeological resources were discovered in the course of the survey. Some recent debris including beer bottles, terra cotta pipe, plastic, and a couch were visible within the APE. Most were located near Parrott Road, suggesting they were products of dumping from the road. No artifacts that appeared over 45 years of age were observed.

Survey Results: Built Environment Resources

No built environment resources were discovered in the course of the survey.

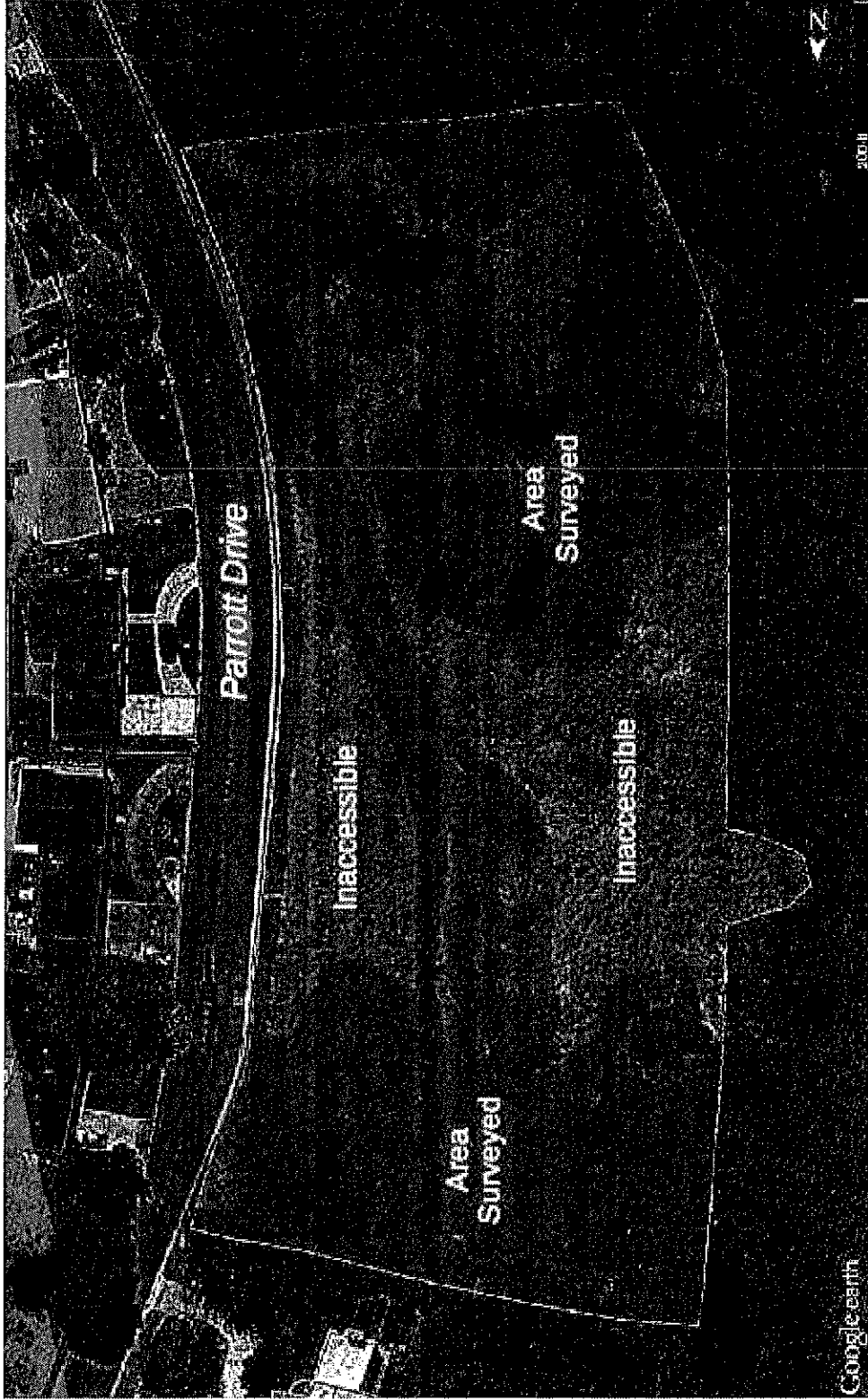

Figure 3: Area of Potential Effect, showing area surveyed

SIGNIFICANCE EVALUATION AND CONCLUSIONS

Framework for Evaluation

Under CEQA, local agencies must consider whether projects will cause a substantial adverse change in the significance of a historical resource, which is considered to be a significant effect on the environment (CEQA §21084.1). A “historical resource” is a resource determined eligible for the National Register of Historic Places (NRHP), the California Register of Historic Resources (CRHR), or local registers by a lead agency (CEQA §15064.5), while a “substantial adverse change” can include physical demolition, destruction, relocation, or alteration of the resource or its immediate surroundings” that impairs the significance of an historical resource in such a way as to impair its eligibility for Federal, State, or local registers. In most cases, whenever a project adversely impacts historic resources, a mitigated Negative Declaration or EIR is required under CEQA §15064.

The NRHP consists of properties that meet one of four significance criteria:

- A. Association with events that have made a significant contribution to the broad patterns of our history;
- B. Association with the lives of persons significant in our past;
- C. Embodiment of the distinctive characteristics of a type, period, or method of construction, represents the work of a master, possesses high artistic values, or represents a significant and distinguishable entity whose components lack individual distinction.
- D. Has yielded, or is likely to yield, information important to prehistory or history.

A property that meets one or more of these significance criteria must also possess sufficient integrity to convey that significance. Seven aspects of integrity are used in National Register evaluations: location, design, setting, materials, workmanship, feeling, and association. Integrity is based on a property’s significance within a specific historic context, and can only be evaluated after its significance has been established.

Evaluation for the CRHR is broadly similar to the Federal process, though evaluation should primarily consider the significance of the property in State and local contexts. The CRHR also uses four criteria, namely:

- 1) association with events that have made a significant contribution to the broad patterns of local or regional history, or the cultural heritage of California or the United States; or
- 2) association with the lives of persons important to local, California, or national history; or
- 3) embodiment of the distinctive characteristics of a type, period, or method of construction, represents the work of a master, or possesses high artistic values; or
- 4) potential to yield, information important to prehistory or history of the local area, California, or the nation.

Resources determined eligible for the NRHP are automatically listed on the CRHR. In addition, historic landmark designations by cities and counties are also presumptively eligible for CRHR.

Under the San Mateo County Historic Preservation Ordinance, historic resources surveys required by the County use the CRHR criteria to evaluate a property’s eligibility for listing as a County Landmark by the Board of Supervisors.

Significance Evaluation and Recommendations

Though it was part of the Spring Valley Water Company watershed lands from approximately 1870-1930, the APE is not associated with any of the water storage or conveyance facilities that give the Crystal Springs area historical significance. Neither is the APE associated with individuals important in local, California, or national history. No historic structures or visible archaeological deposits were discovered in the survey, making it unlikely to contain information important to the history or prehistory of the area. The study area therefore does not appear to contain historical resources as defined in CEQA §15064.5.

Though the archaeological sensitivity of the area is low due to the steep topography of the project site, discovery of subsurface archaeological materials during grading or construction is always possible. If previously unidentified cultural materials are unearthed, work should be halted in that area until a qualified archaeologist can assess the significance of the find.

BIBLIOGRAPHY

Babal, Marianne

1990 *The Top of the Peninsula: A History of Sweeney Ridge and the San Francisco Watershed Lands, San Mateo County, California*. Historic Resource Study prepared for the Golden Gate National Recreation Area, National Park Service.

Beck, Warren A. and Ynez D. Haase

1988 *Historical Atlas of California*. University of Oklahoma Press, Norman, OK.

Bolton, Herbert E.

1927 *Fray Juan Crespi, Missionary Explorer on the Pacific Coast, 1769-1774*. Berkeley: University of California Press.

Bromfield, Davenport

1894 Official Map of San Mateo County, California, Compiled and Drawn by Davenport Bromfield, County Surveyor. On file, Earth Sciences and Map Library, University of California, Berkeley

Burke, William F.

1926 "On the Way to Carey's," *San Francisco Water* 5:4 (October 1926):12-13.

Eldredge, Zoeth S.

1909 *The March of Portola and the Discovery of the Bay of San Francisco*. San Francisco: California Promotion Committee.

ESA (Environmental Science Associates)

1994 *Peninsula Watershed Natural and Cultural Resources*. Cultural resources report Prepared for EDAW under contract to the San Francisco Water Department.

Frederickson, David A.

1974 Cultural Diversity in Early Central California: A View from the North Coast Ranges. *Journal Of California Anthropology* 1(1):41-54.

Golla, Victor

2007 Linguistic prehistory. In Terry L. Jones and Kathryn A. Klar, eds., *California Prehistory: Colonization, Culture, and Complexity*. New York: AltaMira Press, pp. 71-82.

Goode, Erwin G.

1969 *California Place Names*. Berkeley: University of California Press.

Graymer, R.W., B.C. Moring, G.J. Saucedo, C.M. Wentworth, E.E. Brabb, and K.L. Knudsen.

2006 *Geological Map of the San Francisco Bay Region. Scale 1:275,000*. U.S. Geological Survey and California Geological Survey.

Hoover, Mildred Brooke, Hero Eugene Rensch, Ethel Grace Rensch, and William N. Abeloe.
1966 *Historic Spots in California*. 3rd edition. Palo Alto: Stanford University Press.

Hylkema, Mark

2002 Tidal Marsh, Oak Woodlands, and Cultural Florescence in the Southern San Francisco Bay Region. In Jon M. Erlandson and Terry L. Jones, eds. *Catalysts to Complexity: Late Holocene Societies of the California Coast*. Perspectives in California Archaeology, Volume 6. Los Angeles: Cotsen Institute of Archaeology.

Hynding, Alan

1982 *From Frontier to Suburb: The Story of the San Mateo Peninsula*. Star Publishing, Belmont, CA.

Jones, Terry L., Nathan E. Stevens, Deborah A. Jones, Richard T. Fitzgerald, and Mark G. Hylkema

2007 The Central Coast: a Midlatitude Milieu. In Terry L. Jones and Kathryn A. Klar, eds., *California Prehistory: Colonization, Culture, and Complexity*. New York: AltaMira Press, pp. 125-146.

Kneese, George A.

1927 Official Map of San Mateo County, California, Compiled from Official Records and Surveys by George A. Kneese, County Surveyor. On file, Earth Sciences and Map Library, University of California, Berkeley

Levy, Richard

1978 Costanoan. In William C. Sturtevant, and Robert F. Heizer, eds., *Handbook of North American Indians*, Vol. 8 (California). Washington, DC: Smithsonian Institution.

Milliken, Randall

1995 *A Time of Little Choice: the Disintegration of Tribal Culture in the San Francisco Bay Area, 1769-1810*. Novato, CA: Ballena Press.

Milliken, Randall, Laurence Shoup, and Beverly Ortiz.

2009 *Ohlone/Costanoan Indians of the San Francisco Peninsula and their Neighbors, Yesterday and Today*. San Francisco: National Park Service,.

Milliken, Randall, Richard T. Fitzgerald, Mark G. Hylkema, Randy Groza, Tom Origer, David G. Bieling, Alan Leventhal, Randy S. Wiberg, Andrew Gottsfield, Donna Gillete, Viviana Bellifemine, Eric Strother, Robert Cartier, and David A. Fredrickson

2007 "Punctuated Culture Change in the San Francisco Bay Area." In Terry L. Jones, and Kathryn A. Klar, eds., *California Prehistory: Colonization, Culture, and Complexity*. New York: Altamira Press, pp. 99-124. New York: Altamira Press.

Moratto, Michael J.

1984 *California Archaeology*. Academic Press, Orlando, Florida.

Nelson, Nels

1909 Shellmounds of the San Francisco Bay Region. *University of California Publications in American Archaeology and Ethnology* 7: 309-356.

San Mateo County

2015 Assessor's Parcel Data, accessed through Google Earth Pro.

Shoup, Laurence H.

1989 *Historic Property Survey Report for Lower Crystal Springs Dam and Skyline Boulevard Highway Bridge (#35C 004 3), San Mateo County, California*. Prepared for San Mateo County Department of Public Works, San Mateo.

Shoup, Laurence H. and Randall T. Milliken

1999 *Inigo of Rancho Posolmi: The Life and Times of a Mission Indian*. Novato, CA: Ballena Press.

Stanger, Frank M.

1938 *History of San Mateo County*. Cawston Publishing, San Mateo, CA.

1963 *South from San Francisco*. San Mateo County Historical Association, San Mateo.

USGS (United States Geological Survey)

1939 San Mateo 15' Quadrangle. U.S. Government Printing Office, Washington, D.C.

1947 San Mateo 7.5' Quadrangle. U.S. Government Printing Office, Washington, D.C.

1956 San Mateo 7.5' Quadrangle. U.S. Government Printing Office, Washington, D.C.

1968 San Mateo 7.5' Quadrangle. U.S. Government Printing Office, Washington, D.C.

Appendix A
Record Search Results
Northwest Information Center

CALIFORNIA
HISTORICAL
RESOURCES
INFORMATION
SYSTEM

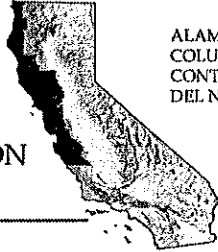

ALAMEDA
COLUSA
CONTRA COSTA
DEL NORTE

HUMBOLDT
LAKE
MARIN
MENDOCINO
MONTEREY
NAPA
SAN BENITO

SAN FRANCISCO
SAN MATEO
SANTA CLATA
SANTA CRUZ
SOLANO
SONOMA
YOLO

Northwest Information Center
Sonoma State University
150 Professional Center Drive, Suite E
Rohnert Park, California 94928-3609
Tel: 707.588.8455
nwic@sonoma.edu
<http://www.sonoma.edu/nwic>

July 8, 2015

File No.: 14-1853

Erica Adams, Project Planner
San Mateo County Planning and Building Division
455 County Center
Redwood City, CA 94063

re: PLN2014-00410 / 1551 Crystal Springs Rd, APN 038131110 / Zmay

Dear Ms. Adams:

Records at this office were reviewed to determine if this project could adversely affect cultural resources. **Please note that use of the term cultural resources includes both archaeological sites and historical buildings and/or structures. The review for possible historic-era building/structures, however, was limited to references currently in our office and should not be considered comprehensive.**

Previous Studies:

XX This office has record of two previous archaeological resources studies, S-6425 (Dietz 1983) and S-39125 (Clark 2012), that include the proposed project area in a general nature, but do not appear to have included any field survey of the proposed project area (*see recommendation below*).

Archaeological and Native American Resources Recommendations:

XX The proposed project area has the possibility of containing unrecorded archaeological site(s). A study is recommended prior to commencement of project activities.

XX We recommend you contact the local Native American tribe(s) regarding traditional, cultural, and religious heritage values. For a complete listing of tribes in the vicinity of the project, please contact the Native American Heritage Commission at 916/373-3710.

 The proposed project area has a low possibility of containing unrecorded archaeological site(s). Therefore, no further study for archaeological resources is recommended.

Built Environment Recommendations:

XX Since the Office of Historic Preservation has determined that any building or structure 45 years or older may be of historical value, if the project area contains such properties, it is recommended that prior to commencement of project activities, a qualified professional familiar with the architecture and history of Sonoma County conduct a formal CEQA evaluation.

Due to processing delays and other factors, not all of the historical resource reports and resource records that have been submitted to the Office of Historic Preservation are available via this records search. Additional information may be available through the federal, state, and local agencies that produced or paid for historical resource management work in the search area. Additionally, Native American tribes have historical resource

information not in the California Historical Resources Information System (CHRIS) Inventory, and you should contact the California Native American Heritage Commission for information on local/regional tribal contacts.

The California Office of Historic Preservation (OHP) contracts with the California Historical Resources Information System's (CHRIS) regional Information Centers (ICs) to maintain information in the CHRIS inventory and make it available to local, state, and federal agencies, cultural resource professionals, Native American tribes, researchers, and the public. Recommendations made by IC coordinators or their staff regarding the interpretation and application of this information are advisory only. Such recommendations do not necessarily represent the evaluation or opinion of the State Historic Preservation Officer in carrying out the OHP's regulatory authority under federal and state law.

For your reference, a list of qualified professionals in California that meet the Secretary of the Interior's Standards can be found at <http://www.chrisinfo.org>. If archaeological resources are encountered during the project, work in the immediate vicinity of the finds should be halted until a qualified archaeologist has evaluated the situation. If you have any questions please give us a call (707) 588-8455.

Sincerely,



Bryan Much
Coordinator

Appendix B
Native American Consultation



ARCHAEOLOGICAL/HISTORICAL CONSULTANTS

609 Aileen Street
Oakland, CA 94609
(510) 654-8635
info@ahc-heritage.com
www.ahc-heritage.com

Native American Heritage Commission
1550 Harbor Blvd, Suite 100
West Sacramento, CA 95691

July 27, 2015

RE: Subdivision at 1551 Crystal Springs Road, San Mateo County

Dear Sir or Madam,

Archaeological/Historical Consultants would like to request a search of the Sacred Lands file and an updated contact list for a project in Hillsborough, San Mateo County. Please see the enclosed request form and map for more detail.

Thanks in advance for your assistance.

Yours truly,

A handwritten signature in cursive script that reads "Suzanne Baker". The signature is fluid and somewhat stylized.

Suzanne Baker

Archaeological/Historical Consultants
suzannebaker@ahc-heritage.com
tel/fax (510) 654-8635

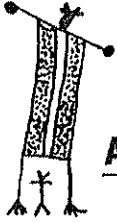

ARCHAEOLOGICAL/HISTORICAL CONSULTANTS

609 Aileen Street
Oakland, CA 94609
(510) 654-8635
info@ahc-heritage.com
www.ahc-heritage.com

Sacred Lands File & Native American Contacts List Request

NATIVE AMERICAN HERITAGE COMMISSION

1550 Harbor Blvd, Suite 100
West Sacramento, CA 95691
(916) 373-3710
(916) 373-5471 – Fax
nahc@nahc.ca.gov

Information Below is Required for a Sacred Lands File Search

Project: 1551 Crystal Springs Drive Subdivision

County: San Mateo

USGS Quadrangle

Name San Mateo 7.5'

Township 4S Range 4W Unsectioned -- Rancho de las Pulgas **MDBM**

Company/Firm/Agency:

Archaeological/Historical Consultants

Contact Person:

Suzanne Baker
609 Aileen Street
Oakland, CA 94609
Phone and Fax : 510-654-8635
suzannebaker@ahc-heritage.com

Project Description:

The proposed project involves subdivision of four lots measuring approximately 0.75 acres each from the existing 60-acre parcel at 1551 Crystal Springs Road (APN 038-131-110). The four lots, which total 3 acres, front on Parrott Drive and will be the locations of new single-family residences. The Area of Potential Effects for the project includes the four lots and a small area (0.25 acres) of slope repair, totaling 3.25 acres more or less. The remaining 57 acres of APN 038-131-110 remain outside the scope of the current study.



ARCHAEOLOGICAL/HISTORICAL CONSULTANTS

609 Aileen Street
Oakland, CA 94609
(510) 654-8635
info@ahc-heritage.com
www.ahc-heritage.com

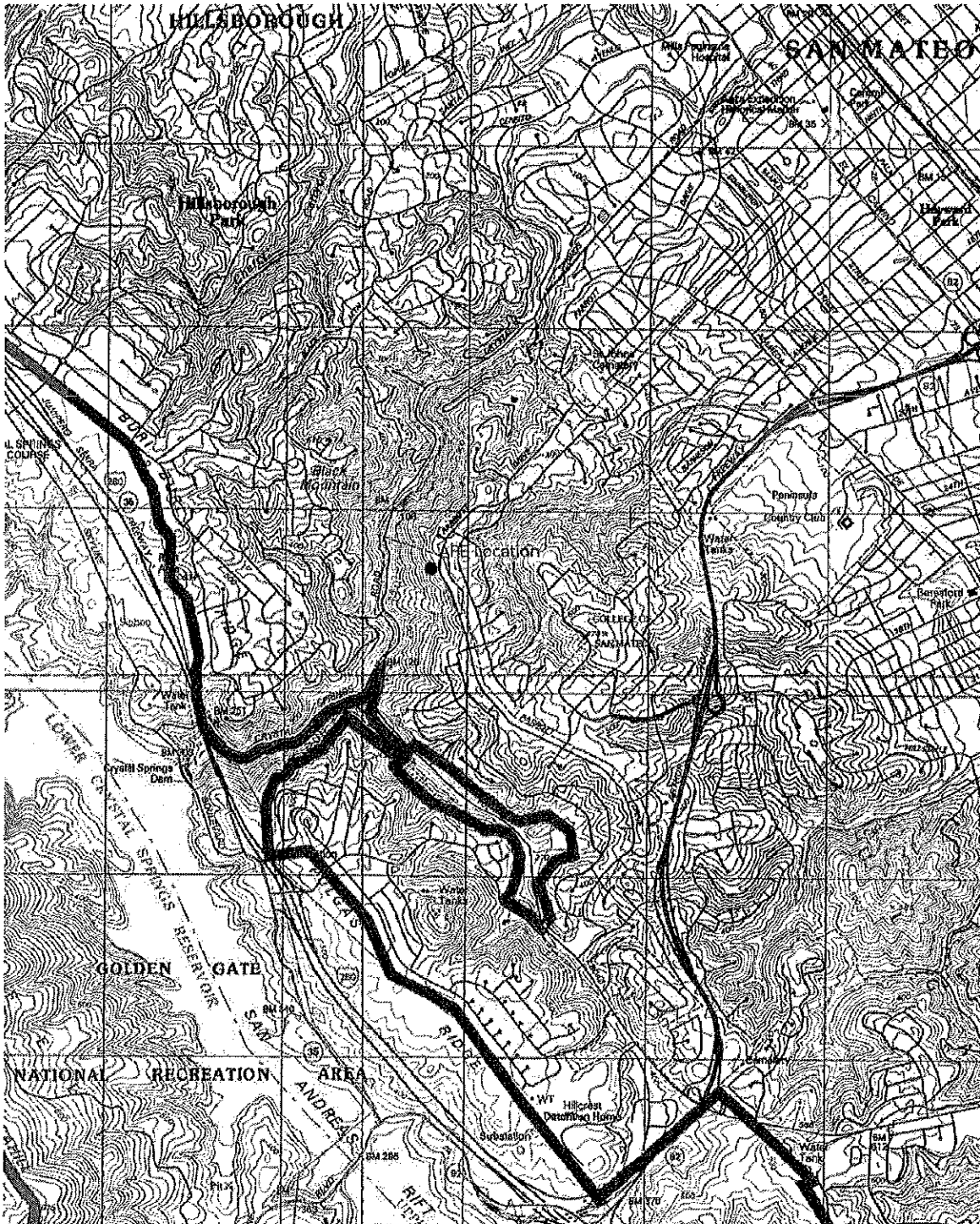

Mercator Projection
WG584
USNG Zone 10SEG
CalTopo.com

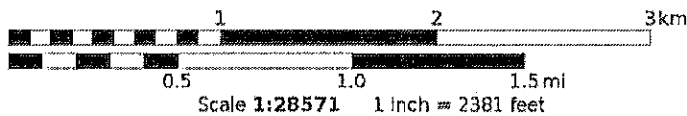

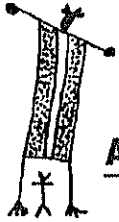

ARCHAEOLOGICAL/HISTORICAL CONSULTANTS

609 Aileen Street
Oakland, CA 94609
(510) 654-8635
info@ahc-heritage.com
www.ahc-heritage.com

July 27, 2015

Tony Cerda
Costanoan Rumsen Carmel Tribe Chairperson
240 E. 1st St.
Pomona, CA 91766

RE: Development at 1551 Crystal Springs Road, Hillsborough

Dear Mr. Cerda:

This letter is to request consultation with the Costanoan Rumsen Carmel Tribe about a proposed development in Hillsborough, San Mateo County. A private developer plans to subdivide four lots measuring approximately 0.75 acres each from an existing 60-acre parcel at 1551 Crystal Springs Road (APN 038-131-110). The four lots, which total 3 acres, front on Parrott Drive and will be the locations of new single-family residences (see attached map).

We would welcome any information that you or members of the Costanoan Rumsen Carmel Tribe have regarding sacred sites or other cultural resources in or near the project area. Likewise, we would be happy to respond to any questions or concerns you might have regarding the project.

Thank you in advance for your assistance.

Yours truly,

Suzanne Baker

Archaeological/Historical Consultants
suzannebaker@ahc-heritage.com
tel/fax (510) 654-8635



ARCHAEOLOGICAL/HISTORICAL CONSULTANTS

609 Alleen Street
Oakland, CA 94609
(510) 654-8635
info@ahc-heritage.com
www.ahc-heritage.com

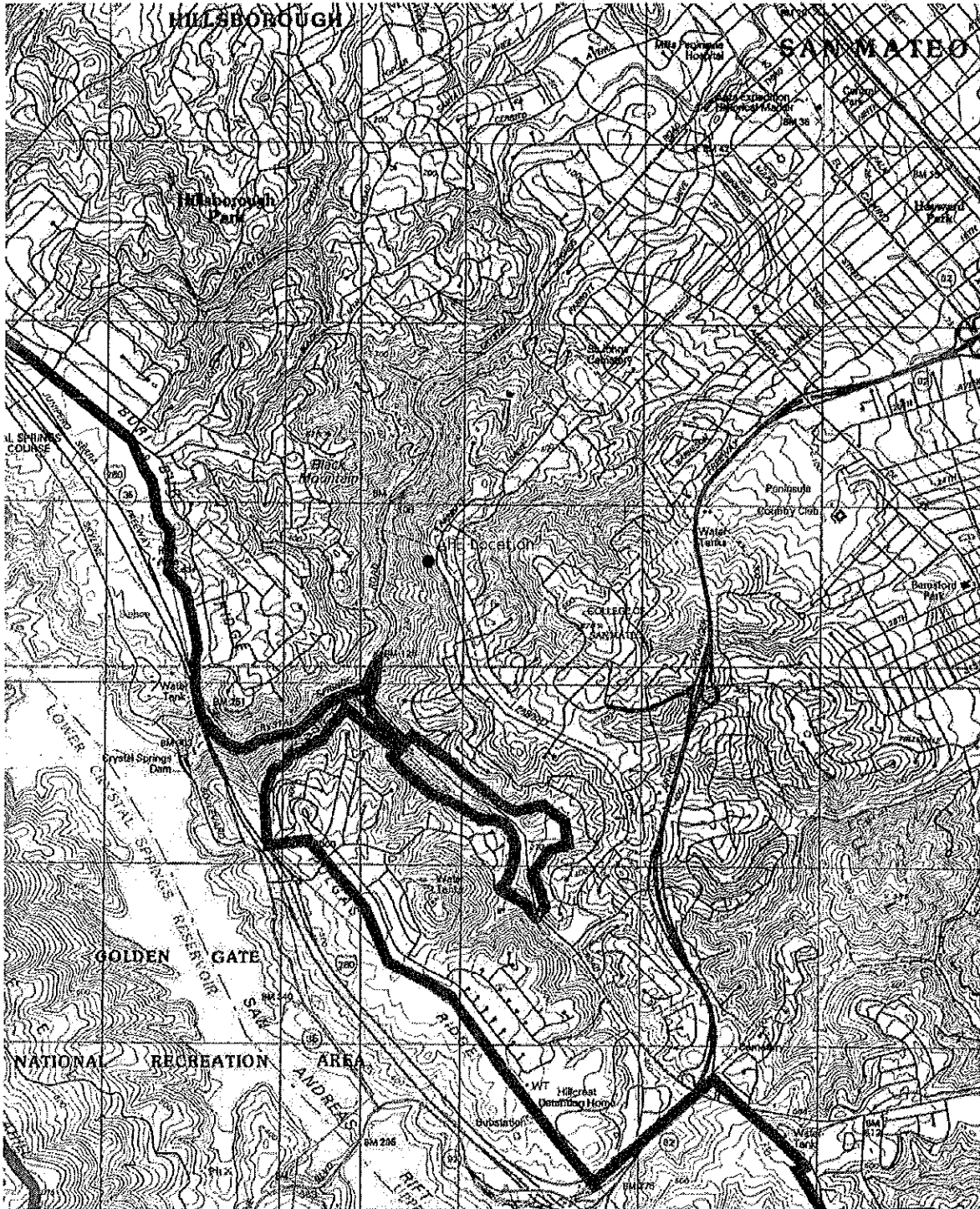

Mercator Projection
WGS84
USNG Zone 10SEG
CalTopo.com

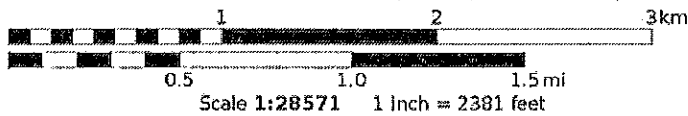



ARCHAEOLOGICAL/HISTORICAL CONSULTANTS

609 Aileen Street
Oakland, CA 94609
(510) 654-8635
info@ahc-heritage.com
www.ahc-heritage.com

July 27, 2015

Andrew Galvan
The Ohlone Indian Tribe
P.O. Box 3152
Fremont, CA 94539

RE: Development at 1551 Crystal Springs Road, Hillsborough

Dear Andy:

This letter is to request consultation with the Ohlone Indian Tribe about a proposed development in Hillsborough, San Mateo County. A private developer plans to subdivide four lots measuring approximately 0.75 acres each from an existing 60-acre parcel at 1551 Crystal Springs Road (APN 038-131-110). The four lots, which total 3 acres, front on Parrott Drive and will be the locations of new single-family residences (see attached map).

We would welcome any information that you or members of the Ohlone Indian Tribe have regarding sacred sites or other cultural resources in or near the project area. Likewise, we would be happy to respond to any questions or concerns you might have regarding the project.

Thank you in advance for your assistance.

Yours truly,

Suzanne Baker

Archaeological/Historical Consultants
suzannebaker@ahc-heritage.com
tel/fax (510) 654-8635



ARCHAEOLOGICAL/HISTORICAL CONSULTANTS

609 Aileen Street
Oakland, CA 94609
(510) 654-8635
info@ahc-heritage.com
www.ahc-heritage.com

July 27, 2015

Ramona Garibay, Representative
Trina Marine Ruano Family
30940 Watkins St.
Union City, CA 94587

RE: Development at 1551 Crystal Springs Road, Hillsborough

Dear Ms Garibay:

This letter is to request consultation about a proposed development in Hillsborough, San Mateo County. A private developer plans to subdivide four lots measuring approximately 0.75 acres each from an existing 60-acre parcel at 1551 Crystal Springs Road (APN 038-131-110). The four lots, which total 3 acres, front on Parrott Drive and will be the locations of new single-family residences (see attached map).

We would welcome any information that you or members of your family may have regarding sacred sites or other cultural resources in or near the project area. Likewise, we would be happy to respond to any questions or concerns you might have regarding the project.

Thank you in advance for your assistance.

Yours truly,

Suzanne Baker

Archaeological/Historical Consultants
suzannebaker@ahc-heritage.com
tel/fax (510) 654-8635



ARCHAEOLOGICAL/HISTORICAL CONSULTANTS

609 Aileen Street
Oakland, CA 94609
(510) 654-8635
info@ahc-heritage.com
www.ahc-heritage.com

July 27, 2015

Jakki Kehl
720 North 2nd St.
Patterson, CA 95363

RE: Development at 1551 Crystal Springs Road, Hillsborough

Dear Ms. Kehl,

This letter is to request consultation about a proposed development in Hillsborough, San Mateo County. A private developer plans to subdivide four lots measuring approximately 0.75 acres each from an existing 60-acre parcel at 1551 Crystal Springs Road (APN 038-131-110). The four lots, which total 3 acres, front on Parrott Drive and will be the locations of new single-family residences (see attached map).

We would welcome any information that you or members of your family may have regarding sacred sites or other cultural resources in or near the project area. Likewise, we would be happy to respond to any questions or concerns you might have regarding the project.

Thank you in advance for your assistance.

Yours truly,

Suzanne Baker

Archaeological/Historical Consultants
suzannebaker@ahc-heritage.com
tel/fax (510) 654-8635



ARCHAEOLOGICAL/HISTORICAL CONSULTANTS

609 Alleen Street
Oakland, CA 94609
(510) 654-8635
info@ahc-heritage.com
www.ahc-heritage.com

July 27, 2015

Muwekma Ohlone Indian Tribe of the SF Bay Area
P.O. Box 360791
Milpitas, CA 95036

RE: Development at 1551 Crystal Springs Road, Hillsborough

To Whom It May Concern:

This letter is to request consultation with the Muwekma Ohlone Indian Tribe about a proposed development in Hillsborough, San Mateo County. A private developer plans to subdivide four lots measuring approximately 0.75 acres each from an existing 60-acre parcel at 1551 Crystal Springs Road (APN 038-131-110). The four lots, which total 3 acres, front on Parrott Drive and will be the locations of new single-family residences (see attached map).

We would welcome any information that you or members of the Muwekma Ohlone Indian Tribe have regarding sacred sites or other cultural resources in or near the project area. Likewise, we would be happy to respond to any questions or concerns you might have regarding the project.

Thank you in advance for your assistance.

Yours truly,

Suzanne Baker

Archaeological/Historical Consultants
suzannebaker@ahc-heritage.com
tel/fax (510) 654-8635



ARCHAEOLOGICAL/HISTORICAL CONSULTANTS

609 Aileen Street
Oakland, CA 94609
(510) 654-8635
info@ahc-heritage.com
www.ahc-heritage.com

July 27, 2015

Ann Marie Sayers, Chairperson
Indian Canyon Mutsun Band of Costanoan Indians
P.O. Box 28
Hollister, CA 95024

RE: Development at 1551 Crystal Springs Road, Hillsborough

Dear Ms. Sayers:

This letter is to request consultation with the Indian Canyon Mutsun Band about a proposed development in Hillsborough, San Mateo County. A private developer plans to subdivide four lots measuring approximately 0.75 acres each from an existing 60-acre parcel at 1551 Crystal Springs Road (APN 038-131-110). The four lots, which total 3 acres, front on Parrott Drive and will be the locations of new single-family residences (see attached map).

We would welcome any information that you or members of the Indian Canyon Mutsun Band may have regarding sacred sites or other cultural resources in or near the project area. Likewise, we would be happy to respond to any questions or concerns you might have regarding the project.

Thank you in advance for your assistance.

Yours truly,

Suzanne Baker

Archaeological/Historical Consultants
suzannebaker@ahc-heritage.com
tel/fax (510) 654-8635



ARCHAEOLOGICAL/HISTORICAL CONSULTANTS

609 Alleen Street
Oakland, CA 94609
(510) 654-8635
info@ahc-heritage.com
www.ahc-heritage.com

July 27, 2015

Linda G. Yamane
1585 Mira Mar Ave.
Seaside, CA 93955

RE: Development at 1551 Crystal Springs Road, Hillsborough

Dear Ms. Yamane:

This letter is to request consultation about a proposed development in Hillsborough, San Mateo County. A private developer plans to subdivide four lots measuring approximately 0.75 acres each from an existing 60-acre parcel at 1551 Crystal Springs Road (APN 038-131-110). The four lots, which total 3 acres, front on Parrott Drive and will be the locations of new single-family residences (see attached map).

We would welcome any information that you or members of your family may have regarding sacred sites or other cultural resources in or near the project area. Likewise, we would be happy to respond to any questions or concerns you might have regarding the project.

Thank you in advance for your assistance.

Yours truly,

Suzanne Baker

Archaeological/Historical Consultants
suzannebaker@ahc-heritage.com
tel/fax (510) 654-8635



ARCHAEOLOGICAL/HISTORICAL CONSULTANTS

609 Aileen Street
Oakland, CA 94609
(510) 654-8635
info@ahc-heritage.com
www.ahc-heritage.com

July 27, 2015

Irene Zwierlein, Chairperson, and Michelle Zimmer
Amah Mutsun Tribal Band of Mission San Juan Bautista
789 Canada Road
Woodside, CA 94062

RE: Development at 1551 Crystal Springs Road, Hillsborough

Dear Ms. Zwierlein and Ms. Zimmer:

This letter is to request consultation about a proposed development in Hillsborough, San Mateo County. A private developer plans to subdivide four lots measuring approximately 0.75 acres each from an existing 60-acre parcel at 1551 Crystal Springs Road (APN 038-131-110). The four lots, which total 3 acres, front on Parrott Drive and will be the locations of new single-family residences (see attached map).

We would welcome any information that you or members of the Amah Mutsum Tribal Band may have regarding sacred sites or other cultural resources in or near the project area. Likewise, we would be happy to respond to any questions or concerns you might have regarding the project.

Thank you in advance for your assistance.

Yours truly,

Suzanne Baker

Archaeological/Historical Consultants
suzannebaker@ahc-heritage.com
tel/fax (510) 654-8635

Subject: Re: Consultation Request, Project in Hillsborough
From: Amah Mutsun <amahmutsuntribal@gmail.com>
Date: Tue, 28 Jul 2015 17:22:00 +0000
To: Daniel Shoup <daniel.shoup@ahc-heritage.com>

We are currently working on the El Cerrito Sewer project in Hillsborough, part of it is on Crystal Springs Road. There are two known archaeological sites in the area of your project. We have recently found Native American human remains in several locations of the area.
Our recommendations are:

All crews involved with this project that dig including landscapers be Cultural Sensitivity Trained.

That a California Trained Archaeological Monitor with field experience be present for all earth movement including landscaping.

That a Qualified and Trained Native American Monitor be present for all earth movement including landscaping.

Thank you
Michelle Zimmer

On Tué, Jul 28, 2015, 10:03 AM Daniel Shoup <daniel.shoup@ahc-heritage.com> wrote:

Dear Ms Zwierlein or Ms. Zimmer,

Please find a consultation request attached for a project in Hillsborough, San Mateo County.

Thanks as always,

Daniel Shoup
Associate Principal
Archaeological/Historical Consultants

--

Sent from [Postbox](#)



County of San Mateo - Planning and Building Department

ATTACHMENT P

Crystal Springs County Sanitation District

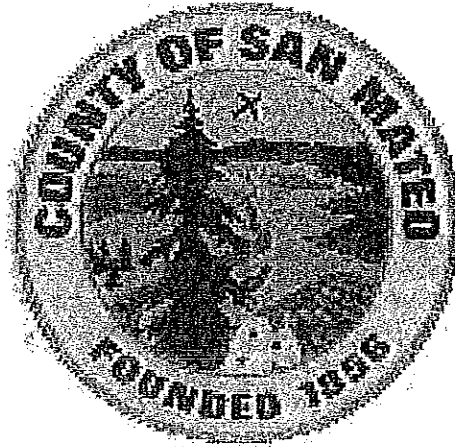

7UN2014-00410
RECEIVED

OCT 17 2014

San Mateo County
Planning Division

Parrott Drive Sanitary Sewer Alternatives Study

February 2003

Prepared by:



Harris & Associates

Parrott Drive Sanitary Sewer Alternatives
Crystal Springs County Sanitary District
San Mateo County

San Mateo County operates the sanitary sewer collection system in Crystal Springs County sanitary District and, in particular, at the top of Parrot Drive between Bel Aire Drive and the Town of Hillsborough city limits. The area was developed in the early 1950's. Due to the topography at the top of the hill, sanitary sewer service was not able to be connected to the system which serves the majority of this area and flows to Ascension Drive at Polhemus Road. Instead, an alternate connection was developed down the adjacent hillside to Crystal Springs Road. Over the years, sections of this hillside have gradually moved, taking pipe and manholes with it.

OVERVIEW

Approximately 29 lots on this section of Parrot Drive are mostly connected to 1,750 l.f. of 6" vitrified clay pipe (VCP) sanitary sewer in Parrot Drive. This sub system is connected to the main Crystal Springs collection system by use of approximately 3,000 ft. of 6" VCP which was installed in the steep hillside below Parrot Drive; a vertical drop of approximately 400 ft. This pipe eventually connects to the main system in the vicinity of Crystal Springs Road and Polhemus Road.

The focus of this report is on the 3,000 l.f. of 6" pipe that lies on that hillside; affectionately known by the sewer maintenance crews as "Billy Goat Hill". In particular, this hillside is very steep in many locations, is accessible only by foot with little or no trail, and appears to be constantly moving; especially during wet weather.

The purpose of this report is to evaluate the existing condition of this pipeline and to propose pipeline replacement or an alternate pump station layout which would serve the area and eliminate the need for this cross country pipeline.

EXISTING PIPELINE

Installed in 1952, this 1,750 l.f. of 6" VCP connects a group of 23 lots on Parrot Drive (addresses 1103 to 1312), and two lesser branches connect 6 other downslope lots on Parrott Drive (1250 to 1298) and Bel Aire Road (1306 & 1312) to 3,000 l.f. of primarily 6" VCP. A map showing the layout of the existing system is shown on the following page. These pipelines are connected to approximately 3,000 l.f. of 6" pipe which lies in the hillside below Parrott Drive and eventually connects to the system's main trunkline in the vicinity of Crystal Springs Road at Polhemus Road. In many locations, this pipeline exceeds slopes of 20%.

In addition, the hillside has a long history of slippage and has been the location of numerous ongoing small landslides. It currently appears to be highly unstable in many areas. These slides have resulted in crushed and broken pipelines and manholes disconnecting from pipelines in areas which have little or no access for maintenance or repair equipment. Thus, foot access and hand maintenance and repairs are the only remedy available to County crews in this area. In addition, the existence of poison oak and copious other vegetation has added to access and maintenance difficulties.

Subsequent to the 1952 initial construction, County records show the first sections of pipe immediately below Parrott Drive began to fail almost immediately. In 1960, approximately 500 l.f. of 6" VCP in the vicinity of MH 15 to MH 25 and MH 15 to MH 19 was replaced. The project used 6" Transite, Class 100 (asbestos cement pipe; 6"ACP) to replace the clay. The ACP was considered to be a stronger material; primarily used for water pipe. Sections of this repair would later fail in the mid 90's.

Over the years, additional manholes began to slide down the hill and sections of pipe would fail including MH 25, MH 31 and Riser 32. All of the pipe in the vicinity of these structures has now been abandoned.

In approximately 1995, a number of sections of pipe ultimately had to be "temporarily" bypassed with over 600 l.f. of 4" PVC pipe which was installed above ground. In order to maintain somewhat of a constant slope, much of this pipe was supported by fence posts and wire. Today, over 8 years later, these temporary pipes still exist, from MH11 to MH14 and from MH15 to MH 17. Much of this PVC pipe has significantly deteriorated due to constant exposure to sunlight and is currently becoming brittle and subject to failure. In addition, all of the laterals from the 6 downslope lots have been abandoned and currently exist in the form of 4" corrugated plastic flexible pipe laying directly on top of the ground. While the County's maintenance crews regularly visit this area, the visits are infrequent and small spills or overflows can sometimes go for weeks undetected due to the remoteness of the area.

The 4" PVC bypass between MH 11 and MH 14, which lays directly on top of the ground, is of particular concern in that it lies outside the existing easement as it runs cross country. The area is completely overgrown with vegetation making any monitoring for leaks almost impossible.

The result is a temporary, unmonitored system which is highly subject to small sewage spills of unknown quantity or duration. This writer has twice witnessed this condition during field visits. Both instances have resulted in an immediate report to County maintenance crews for quick remediation.

Photographs of these existing conditions follow:

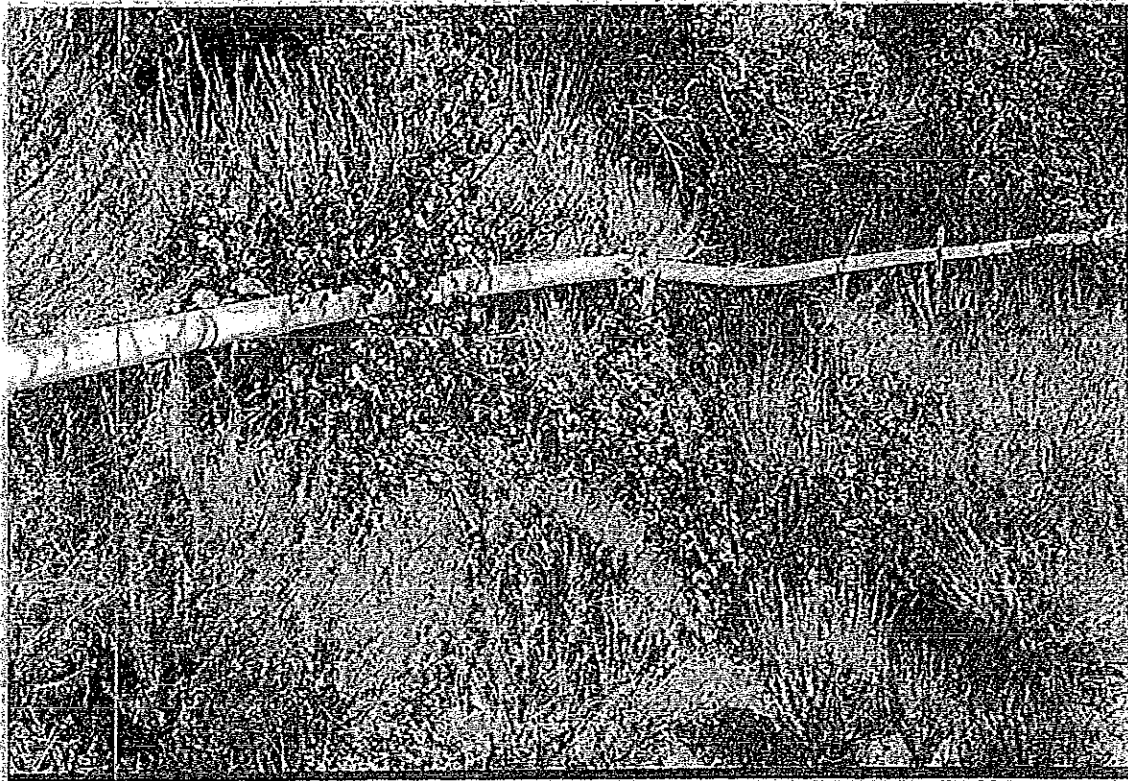

Temporary 4" PVC bypass pipe installed below Parrott Drive

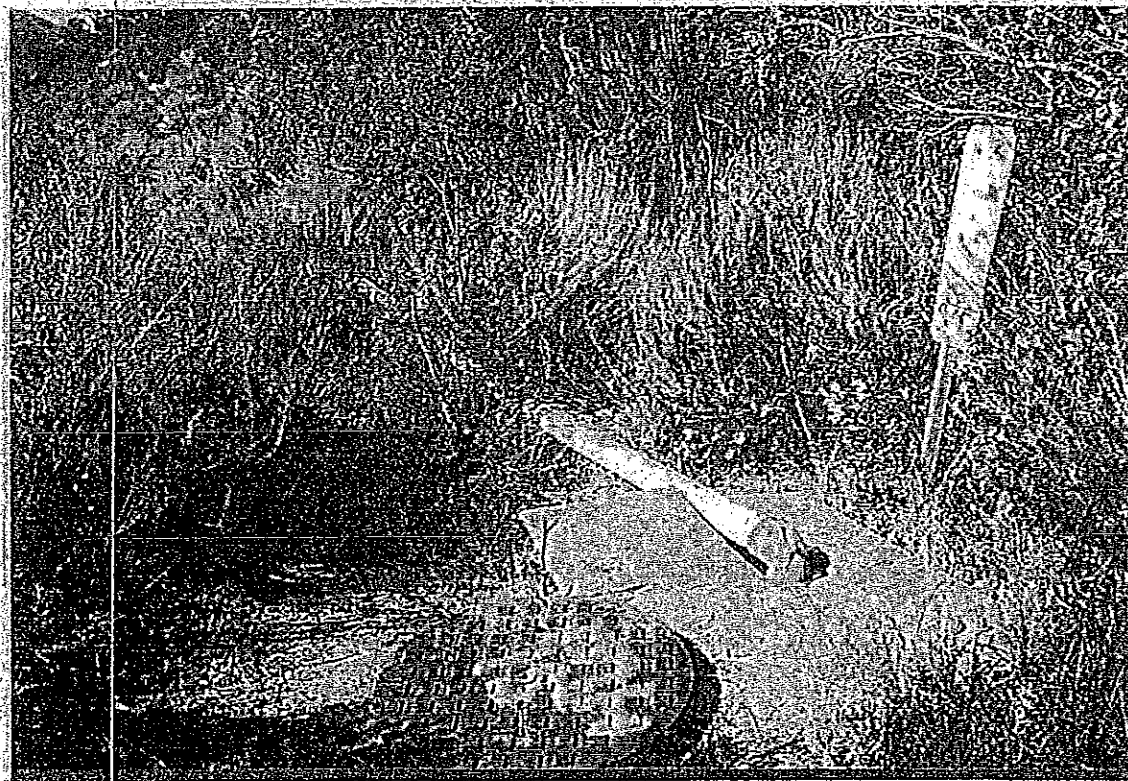

Temporary Bypass Pipe from MH 17 entering MH 15

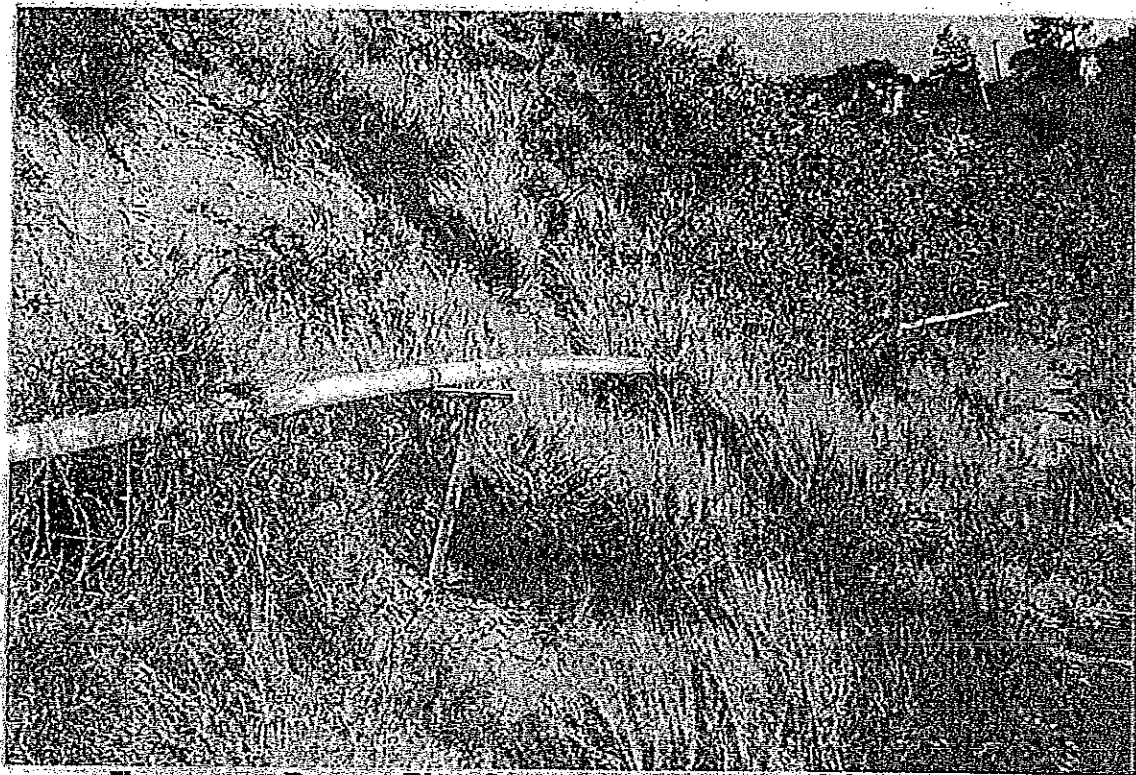

Temporary Bypass Pipe Supports between MH 15 and MH 17



Temporary Bypass Pipe on ground between MH 11 and MH 14



Example of difficult access – MH 13



Example of MH re-exposed after being covered by sliding hillside



Laterals from 1306 & 1312 Bel Aire Road are connected into one 4" flex pipe



Combined laterals flowing into MH 30

Near the lower end of the hillside, the pipeline approaches a creek and parallels the bank of the creek down to Polhemus Rd. MH 6 was originally located adjacent to the creek bank. During the heavy rainstorms in the mid 1990's, the bank became severely eroded and eventually exposed the base of MH 6 which ultimately fell into the creek thus allowing raw sewage to run into the creek for an unknown period of time. State Fish and Game personnel reported the discovery of the broken pipe to County maintenance crews. Both the repair of the pipeline and the abandoned MH are shown:

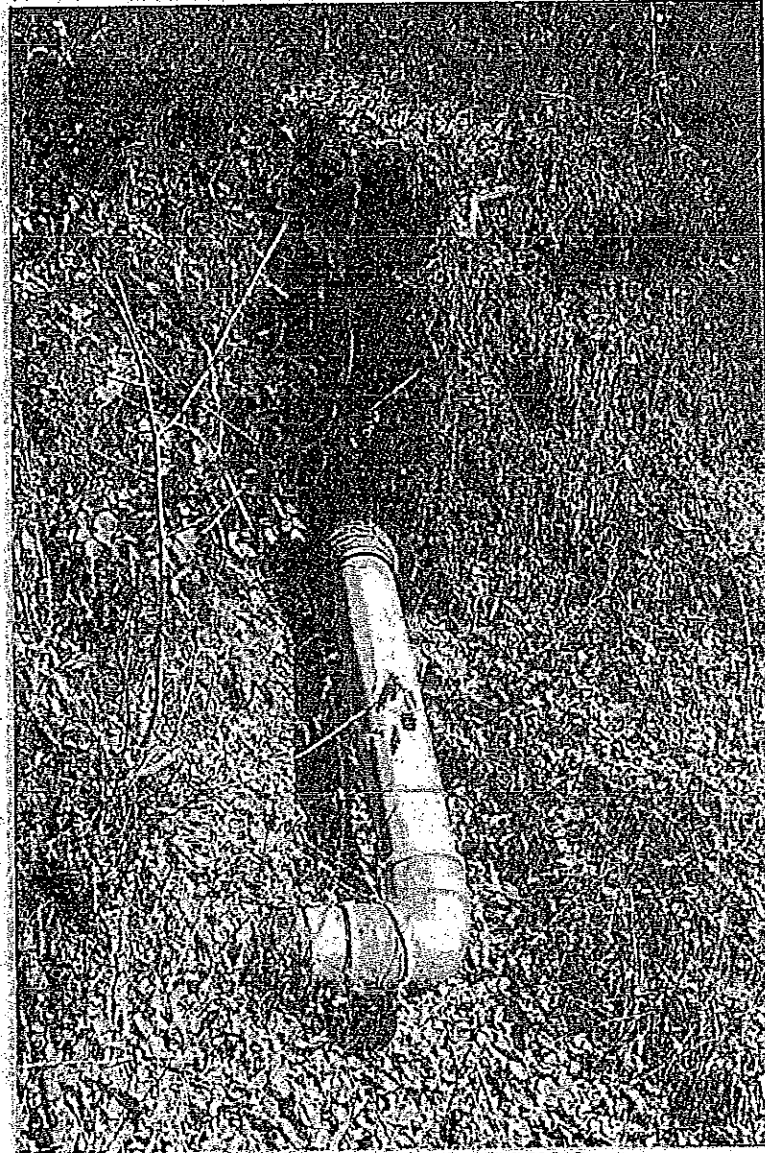

Former Location of MH 6

It is likely that, as the MH base began to move and become separated from the pipe, sewage flow from the exposed pipe caused the final erosion around the MH base. The resulting erosion left the brick MH upside down and completely in tact, approximately 30 feet down the hill near the creek. While difficult to pick out in the following photograph, it serves as a reminder of the potential that a remote pipeline on a slipping hillside has to cause damage.



Upside down MH 6 in it's new, unused location

After the pipeline reaches Crystal Springs Road, it crosses Crystal Springs Creek where it connects to the Town of Hillsborough's collection system, per agreement. This crossing currently carries all of the flow from the entire Sanitary District; a peak wet weather flow of approximately 3 million gallons per day. The pipe crossing the creek is 16" ductile iron pipe. It appears that it may have originally been constructed below the flowline of the creek without any encasement to protect from erosion. Over time, the creek bottom has eroded to 2 feet or more below the bottom of the pipe, a tree has fallen across the pipe, and it appears to be a significant "debris catcher." The County's Polhemus Road sewer pipeline replacement project, to be constructed in Summer, 2003, will reroute all but the flow from these 29 lots away from this crossing; thus significantly reducing the potential overflow to the creek should this vulnerable pipe become strained during a major storm.

Sewage Collection Alternatives

After review of the existing topography and the configuration of the existing collection system it was determined that two basic alternatives were available; either replace the majority of the existing pipelines with a more reliable gravity system or install pumps to reroute the sewage to a different point of collection. Referring to the previous map, which shows the existing system, it can be seen that 23 lots flow directly to the Parrott Drive collector before flowing down the hillside pipeline. That location is an ideal for a Lift Station. An additional 6 downslope lots flow directly to the hillside system. Alternately, these lots would require individual pumps to carry their discharge up to Parrott Drive.

Alternative 1 -- Replace Gravity Pipelines

In developing this Alternative, several assumptions must first be made. First, environmental clearance of the hillside, for the construction of new and replacement of existing, along the pipeline route is assumed. While cursory discussions with Public Works' Lisa Ekers have revealed no immediate roadblocks, a thorough review of the area must be completed. This would include any potential State Fish and Game Permits; both for the hillside riparian area as well as a Stream Alteration Permit for clearing and rehabilitating the pipeline crossing Crystal Springs Creek.

Second, it must be assumed that geotechnical clearance is provided and that the County accepts any potential liability. In other words, it can safely be assumed that any disturbance of the hillside; whether it be for clearing of brush for access, excavation for new pipe, or small excavations for pipe replacement using trenchless technology; will be considered to be the "trigger" should subsequent damage occur. The minute the County steps foot on the project, those "deep pockets" will be the first avenue for retribution. Native backfill materials would be used wherever possible, as opposed to the County Standard using sand bedding, in order to avoid any potential of the bedding material being used as a "conduit" for water on the hillside.

It is obvious that the use of rigid pipe for construction in the hillside is the source of most of the damage to the existing collection system. The pipe was either crushed by the moving hillside or sheared by the moving manholes. This Alternative proposes the use of 6" High-Density Polyethylene (HDPE) pipe. These pipe sections are thermally-fused together such that one length of pipe lies between manholes. While being flexible, the standard SDR-17, which denotes diameter to thickness ratio, is very tough when it comes to manhole connections. The 6" pipe proposed for this project is over $\frac{3}{8}$ " thick and is rated for 100 psi. In particularly difficult areas, SDR-11, 6" HDPE pipe could be specified with a wall thickness of $\frac{5}{8}$ " and 160 psi rating. *One complete section of tough, yet flexible pipe between manholes is key to this hillside construction.* HDPE would be specified for both the new construction and for the pipebursting portions of the project. This heavy-wall pipe is also important due to the previously-mentioned use of native backfill materials whenever possible. This same material would be used as a pipe within a pipe in lining the 16" DIP which crosses Crystal Springs Creek.

As shown on the following page, this Alternative includes approximately 700 feet of new 6" HDPE pipeline along a new route, 1700 feet of 6" HDPE pipebursting the existing 6" VCP and the potential replacement of 15 manholes. This Alternate also proposes the installation of 700 feet of new 4" HDPE laterals, in common trenches wherever possible, and the extension of those laterals to abandon approximately 500 feet of 6" VCP. It should be noted that, contingent on detailed inspection of the lower hillside system, there is a remote possibility that a portion of these pipes would not need replacement as they are not located in the same slippage areas as the top and intermediate sections of the hillside. This report assumes that all pipeline sections require replacement.

The small tributary creek, previously mentioned near the bottom of the hill, prevents rerouting to join the new Polhemus Road Sanitary Sewer. Therefore, the existing Crystal Springs Creek crossing must remain in use. This Alternate assumes the permitting, cleanup and reinforcement

of the existing 16" DIP crossing and the insertion of an 8" HDPE pipe within the DIP for added safety.

Finally, after completion of construction, it is assumed that no vehicular access for maintenance will be allowed. The single parcel on Polhemus Road, across from the Polhemus/Crystal Springs intersection, will also require rerouting of their service lateral.

Alternative 2 - Install Pump Stations

Development of this alternative does not require the same assumptions as required for Alternative 2. In fact, the County has a relatively good record with the use of County-owned and maintained individual pump stations in the Emerald Lakes area. As shown on the following page, this Alternative proposes the installation of 3 common pump stations, each to be used by 2 adjacent lots. These pump stations would consist of a wet well, two alternating grinder pumps, a control panel with alarm and a 2" force main to the nearest gravity sewer. The proposed configuration is shown. Five of these pump stations would pump twice, once at the individual station and then again at the neighborhood pump station. The small pump stations would be specified to coincide with the existing individual pump stations in order to use the same spare parts, controls and pumps which are kept in stock on County shelves.

As seen in the layout, approximately 27 lots would be tributary to the neighborhood pump station, which is proposed to be located just downstream and west of MH 20, at the low point of that section of Parrott Drive. The layout and configuration of this station would be very similar to the stations currently maintained by the County except on a somewhat larger scale. The wet well would consist of a cast-in-place or precast concrete base with sections of 6-foot or 7-foot diameter concrete pipe. The wet well volume would be designed to store 4 hours of peak flow. This storage allows for a comfortable emergency response time without the risk of a spill or overflow. To minimize corrosion, the wet well would be plastic lined. Adjacent to the wet well, the discharge piping, check valves and control valves would be located in a valve pit. Both the wet well and the valve pit would be accessed via stainless steel hatches. Submersible pumps would set on stainless steel guide rails for easy installation and removal. The entire facility would be located at or below grade with the exception of the control panel and a fence. Underground electric power service would come from an existing pole located across the street. Due to the small size of this facility, it is not recommended to include an onsite standby generator. This would simply increase maintenance and noise at the site and the County has portable generators at the maintenance yard which can be used for this application. *Disagree*

Assuming 240 gal/day per lot and a peaking factor of 3.9, the pumps would be sized to pump a maximum of 20 gallons per minute. Two pumps would alternate operation and would provide a backup should one pump fail. The submersible pumps are sized to carry a 3-1/2" solid and would be connected, via the valve pit, to a 1,200 foot long 4" PVC force main. The force main would connect to MH 121, further south on Parrott Drive.

The control panel would be equipped with a special electrical plug and a transfer switch to connect the portable generator. It would also include an alarm system which will notify the on-call person or the Sheriff's Department of any problem. Current technology allows the operator

to remotely monitor the station and determine the severity of the problem. For instance, during a power outage, the operator could remotely monitor the wet well level and determine how quickly the portable generator might be required.

The connection point and depth of the lateral, which serves the house adjacent to the pump station site at 1136 Parrott Drive, is unknown. The design should consider a wet well depth which would serve this property without the use of an additional individual pump station. (That design must also be sure that backflow devices are included on that line.) The current cost estimates include an individual pump station at that site.

Upon completion of the pump system, the existing hillside system could be entirely abandoned or be used to carry away drainage water from those lots which appear to be particularly susceptible.

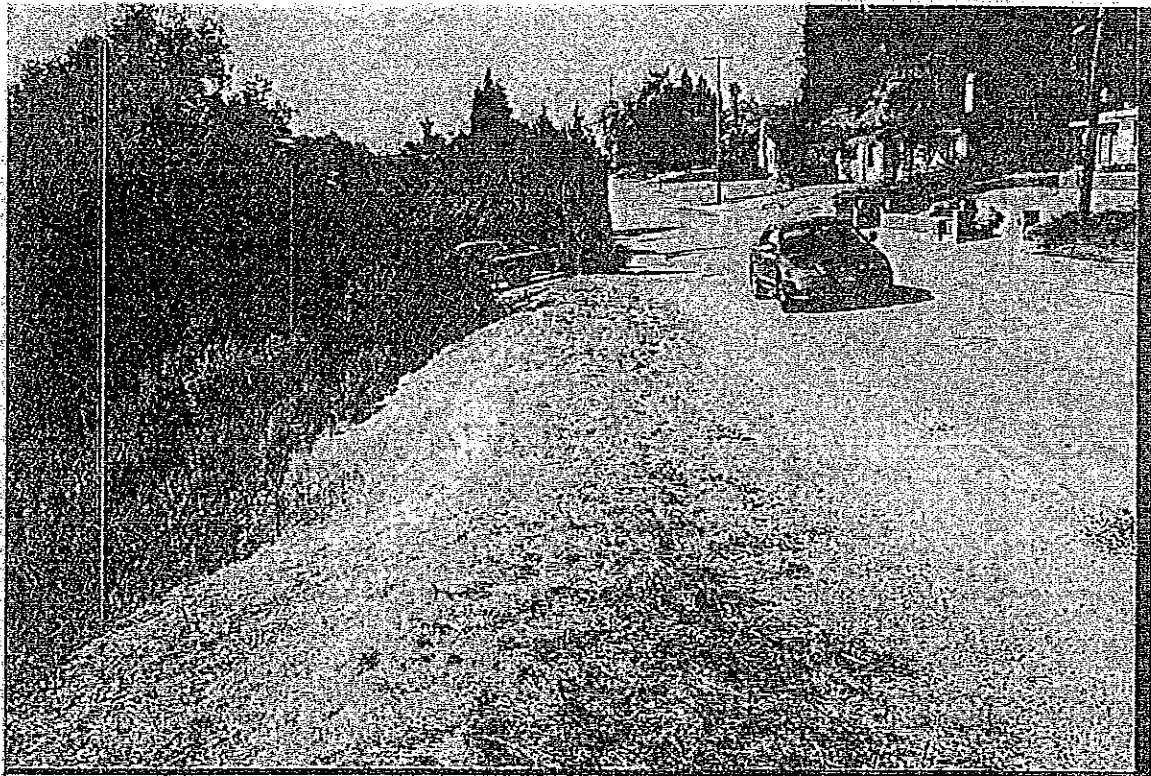

Main Lift Station Site approximately 30 feet left of MH 20 (in street)

7

Cost Estimates

The estimates for both Alternatives are presented below:

Alternative 1 - Replace Gravity Pipelines

Description	Unit Cost	Units	Quantity	Total
Construction Costs				
Replace 6" Pipe (new)	\$200	LF	700	\$140,000
Replace 6" Pipe (pipeburst)	\$150	LF	1700	\$255,000
Replace 4" Laterals (2 pipes/single trench)	\$80	LF	700	\$56,000
Manhole	\$5,000	EA	15	\$75,000
Creek Crossing	\$40,000	LS	1	\$40,000
Construction Cost Subtotal				\$566,000
Contingency (20%)				\$113,000
Construction Cost Total				\$679,000
Design Costs (8%)				\$54,000
Construction Administration Costs (12%)				\$82,000
Land/Easement Acquisition (1 prop owner)	\$50,000	LS	1	\$50,000
Total Project Cost (rounded)				\$865,000

It should be noted that the pipe unit prices are estimated on the high side to include site access issues, potential hand digging requirements, environmental protection issues and potential mitigation which may be required. As previously mentioned, a portion of the lower hillside pipes may not need replacement as they are not located in the same slippage areas as the top and intermediate sections of the hillside. For the purposes of this estimate, complete replacement is assumed.

Alternative 2 - Install Pump Stations

Description	Unit Cost	Units	Quantity	Total
Construction Costs				
Pump Station (24 units)	\$100,000	LS	1	\$100,000
Pump Station - duplex (serving two lots)	\$15,000	EA	3	\$45,000
Pump Station - duplex (serving one lot)	\$10,000	EA	1	\$10,000
4" PVC Force Main	\$60	LF	1200	\$72,000
2" PVC Force Main	\$50	LF	1000	\$50,000
Construction Cost Subtotal				\$277,000
Contingency (20%)				\$55,400
Construction Cost Total				\$332,400
Design Costs (12%)				\$39,900
Construction Administration Costs (12%)				\$39,900
Land/Easement Acquisition	\$10,000	EA	7	\$70,000
Total Project Cost (rounded)				\$482,000

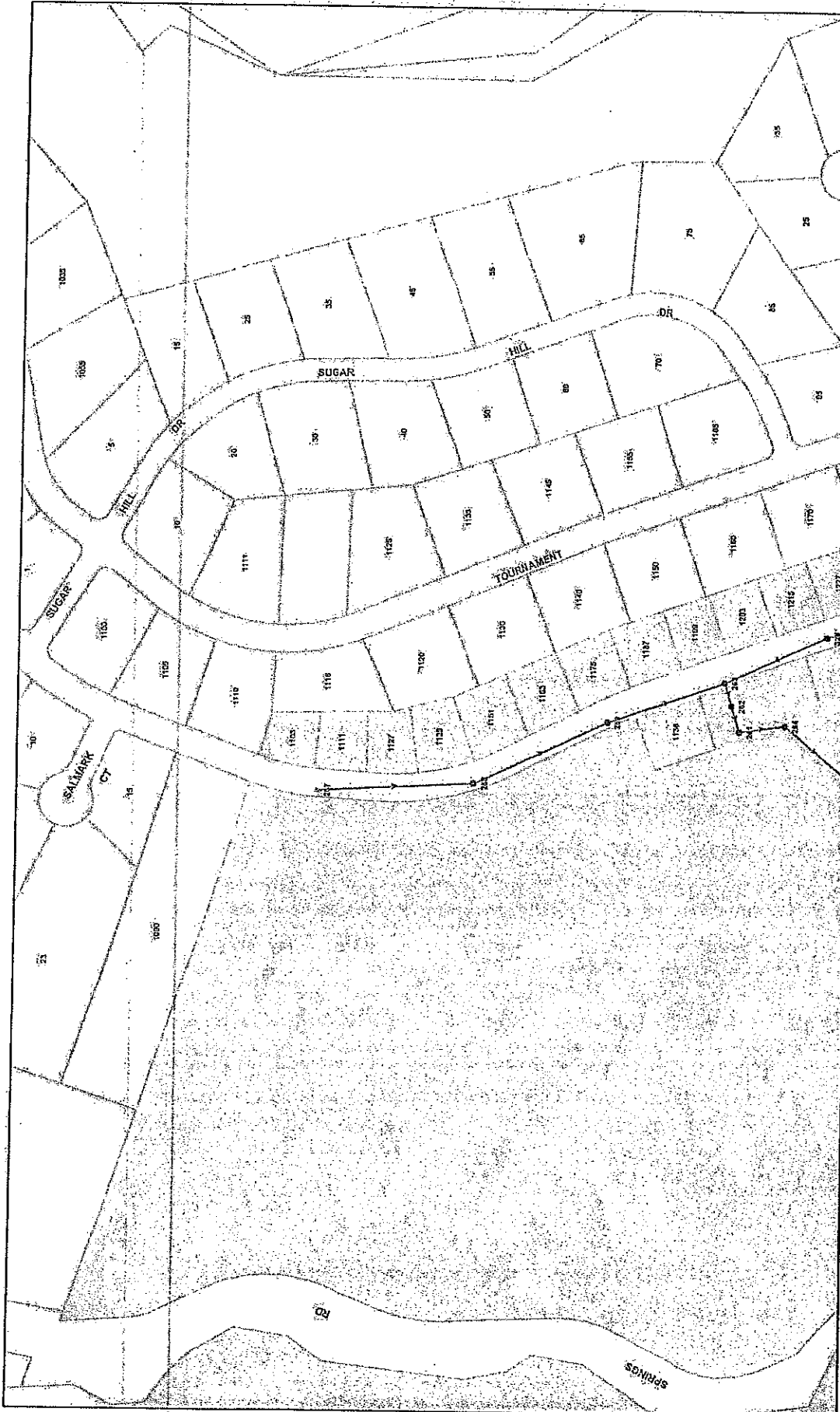

Sheet Number **9**

Location Map:

8	9	10
10	11	12

For Reference Only

Sanitary Sewer System

Revised: 11/10/11

County of San Mateo
Department of Public Works
 James C. Porter, Director

The County does not guarantee the accuracy or currency of the information on this map. Information shown on this map page is approximate. Exact locations should be verified in the field.

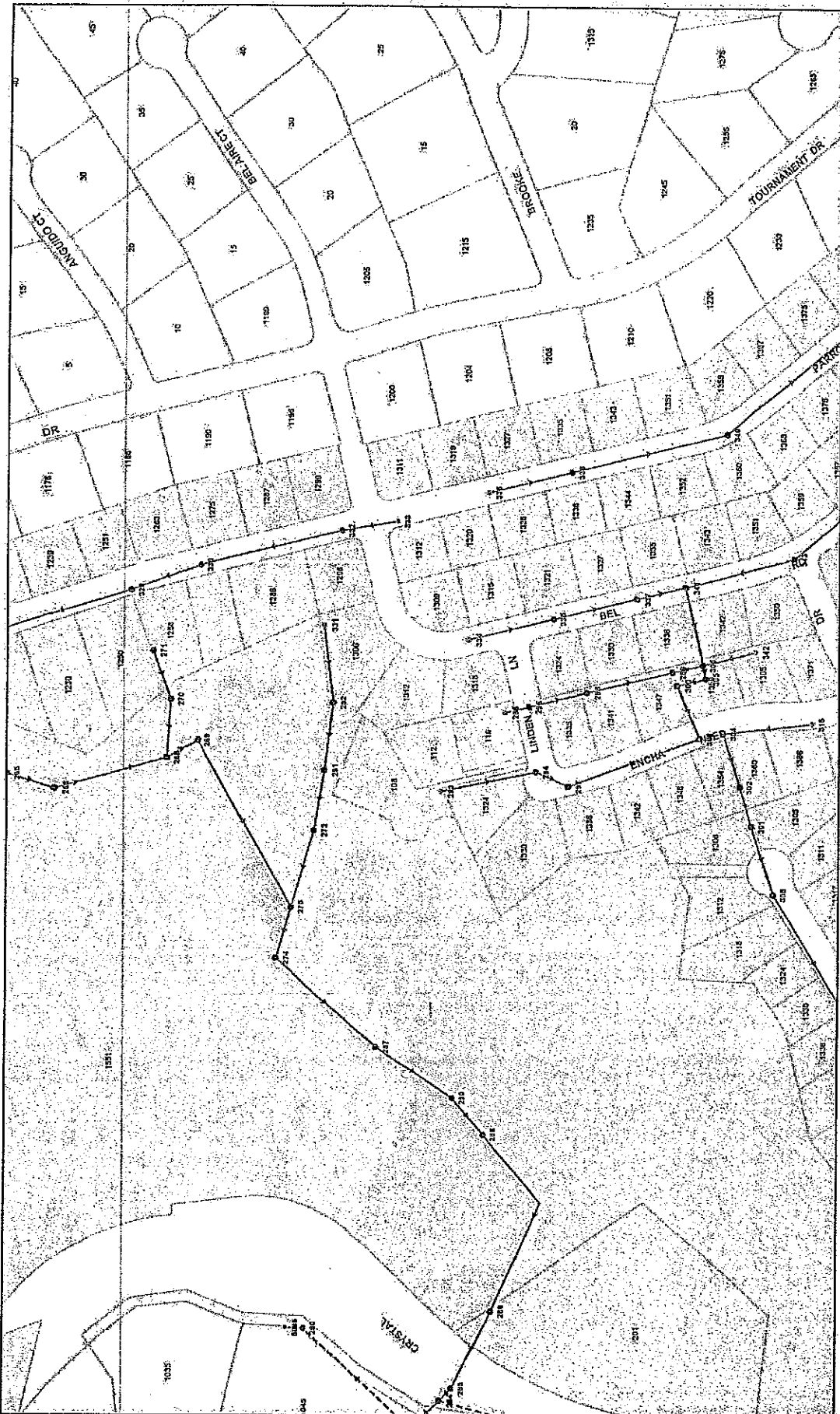

Location Map		Sheet Number
9	10	11
11	12	13
14	15	16

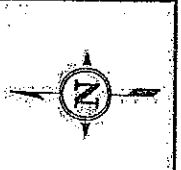

For Reference Only
Sanitary Sewer System
 Revised: 11/20/15

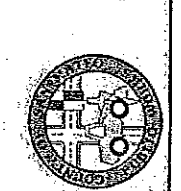

County of San Mateo
Department of Public Works
 James C. Porter, Director

The County does not guarantee the accuracy or currency of the information on this map page. Information shown on this map page is approximate. Exact locations should be verified in the field.





County of San Mateo - Planning and Building Department

ATTACHMENT Q

PUN2014-00410

COUNTY OF SAN MATEO

BOARD OF SUPERVISORS
DAVE PINE
CAROLE GROOM
DON HORSLEY
WARREN SLOCUM
ADRIENNE J. TISSIER



Department of Public Works

JAMES C. PORTER
DIRECTOR

555 COUNTY CENTER, 5TH FLOOR • REDWOOD CITY • CALIFORNIA 94063-1666 • PHONE (650) 363-4100 • FAX (650) 361-8220

RECEIVED

December 3, 2013

Mr. Nick Zmay
751 Laurel Street PO Box #409
San Carlos, CA 94070

OCT 17 2014

San Mateo County
Planning Division

Re: Sewer Service for Proposed Parrott Drive Subdivision (APN: 038-131-110)

Dear Mr. Zmay:

This letter is a follow-up to our recent telephone conversations and electronic correspondences regarding the Crystal Springs County Sanitation District's (District) ability to provide sewer service to the proposed four-parcel subdivision along Parrott Drive (copy of marked-up assessor parcel map page enclosed). The District is able to provide sewer service to the proposed subdivided parcels. However, the requirements listed below must be satisfied prior to connections to the District sewer main on Parrott Drive can be made:

1. There are capacity issues in the sewer lines downstream of the project area within the Town of Hillsborough and the City of San Mateo during wet weather events. The project shall minimize its impact on the downstream systems by completing capital improvement projects within the District that would reduce inflow and infiltration into the District's system in an amount equal to the projected sewage discharge amount to the District from the project. This type of mitigation would mitigate the project's effect on downstream pipes by reducing or eliminating wet weather inflow and infiltration from the District to downstream of the project.

I understand, based on our telephone conversation on November 19, 2013, that you are aware that District sewer mains exist within the referenced parcel and downstream of the four proposed parcels. As we discussed, segments of these sewer mains have experienced damage due to earth movement over the past several years and are in need of replacement. A study prepared by Harris & Associates, the consultant firm retained by the District, in 2003 evaluated the conditions of the sewer mains and estimated the cost to replace the pipes in their current locations or install a pump and force main system as an alternative (Harris Study). Due to the significant cost of either option and the District's budgetary constraints, only temporary repairs were made to the damaged pipe segments. Permanent repairs to the District mains that would convey the sewage from the proposed four parcels remain a priority for the District. The District is willing to discuss a project to repair the District pipe segments as a mitigation project to offset sewage generation and eliminate infiltration and inflow to the downstream sewer facilities. For your information, I've enclosed with this letter a copy of the Harris Study and pages (9 and 11) of the County sanitary sewer system map depicting the existing sewer mains in the vicinity of your project site.

Mr. Nick Zmay

Re: Sewer Service for Proposed Parrott Drive Subdivision (APN: 038-131-110)

December 3, 2013

Page 2

2. The developer of the proposed subdivision must demonstrate that the District sewer mains utilized to transport sewage from the subdivision has the peak wet weather capacity for conveying the additional flow generated from the 4 residences. If it is determined that the lines are insufficient to convey the additional flow, the developer may need to upgrade the sewer lines to accommodate this subdivision.
3. Should a pump system be utilized to deliver sewage from the four parcels to the District's sewer main on Parrot Drive, the District will require that a covenant for each parcel be prepared stating that the ownership, operation, maintenance and repair of the pump system will be the responsibility of the property owner. The covenant must be prepared, signed, notarized, recorded with the San Mateo County Recorder's Office, and a copy provided to the District prior to final sewer sign-off for the building permit.
4. Each new parcel will require a 4" lateral with a minimum of 2% slope and a standard cleanout installed at the property line or on the property within 5' of the property line.
5. Plan review, Sewer Inspection Permit, and connection fees will be required for each new parcel. A Sewer Inspection Permit is required for the inspection of the property line cleanout and the connection to the main.

If you have any questions, please contact Mark Chow at (650) 599-1489 or myself at (650) 599-1497.

Very truly yours,

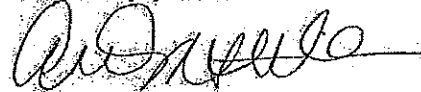

Ann M. Stillman, P.E.

Deputy Director

Engineering and Resource Protection

AMS:MC:ca

F:\Users\admin\Utility\Sewers\Districts\Crystal Springs CSD\Property Information\Parrott Drive Subdivision\Sewer Service Letter.docx
G:\users\utility\Sewers\Districts\Crystal Springs CSD\Property Information\Parrott Drive Subdivision\Sewer Service Letter.docx

Encl: Marked-up Assessor Parcel Map (Book 38, Page 13)
Parrott Drive Sanitary Sewer Alternatives Study (February 2003) - Harris Study
County of San Mateo Sanitary Sewer System Maps (Sheets 9 and 11)

cc: Mark Chow, P.E., Principal Civil Engineer, Utilities-Flood Control-Watershed Protection
Julie Young, P.E., Senior Civil Engineer, Utilities-Flood Control-Watershed Protection



County of San Mateo - Planning and Building Department

ATTACHMENT R

NOTES:

- 1) ALL DISTANCES SHOWN ARE GRID DISTANCES. TO OBTAIN GROUND DISTANCES MULTIPLY BY 1.00007500.
- 2) AREAS WITH DENSE VEGETATION HAVE CONTOURS DEPICTED BY A DASHED LINE TYPE AND THESE AREAS MAY NOT MEET NATIONAL MAP ACCURACY STANDARDS.
- 3) DATE OF AERIAL PHOTOGRAPHY WAS NOVEMBER 1, 2006, CONTOUR INTERVAL = 2 FEET.
- 4) SITE AREA IS 60.263 ACRES±.

BASIS OF BEARINGS:

THE BEARINGS SHOWN ON THIS MAP ARE BASED ON THE NORTH AMERICAN DATUM OF 1983 (NAD 83) CCS83, EPOCH 2002.75, CALIFORNIA ZONE 3.

BENCHMARK:

SURVEY DISK ENCASED IN PVC PIPE WITH ACCESS COVER SET IN CONCRETE FLUSH WITH THE GROUND, LOCATED ON THE WEST SIDE OF SKYLINE BLVD. BETWEEN HIGHWAY 280 AND LOWER CRYSTAL SPRINGS RESERVOIR, ABOUT 284 FEET SOUTHEAST OF THE INTERSECTION OF GOLF COURSE DRIVE AND SKYLINE BLVD. 39.2 FEET NORTHWEST OF A 50-MILE PER HOUR SPEED LIMIT SIGN, 6.8 FEET NORTHEAST OF A 6 FOOT HIGH STRAND BARBED WIRE FENCE AND LEVEL WITH SKYLINE BLVD. THE DISK IS 0.2 FEET BELOW THE LID OF THE ACCESS COVER.

NGS PID = AB7675
ELEVATION = 634.4 FEET
DATUM: NAVD 88

OWNER AND SUBDIVIDER:

STEVE ZMAY AND NICK ZMAY
751 LAUREL STREET, # 409
SAN CARLOS, CA 94070
TEL: (650) 430-0075

CIVIL ENGINEER / LAND SURVEYOR:

DAN MacLEOD
MacLEOD & ASSOCIATES, INC.
965 CENTER STREET
SAN CARLOS, CA 94070
TEL: (650) 593-8580

ASSESSOR'S PARCEL NUMBER:

038-131-110

EXISTING AND PROPOSED ZONING:

RM

FLOOD ZONE:

ZONE X

UTILITIES:

WATER:	CAL WATER
SANITARY SEWER:	COUNTY OF SAN MATEO
GAS & ELECTRICAL:	PG & E
TELEPHONE:	AT&T COMMUNICATIONS
FIRE:	CAL FIRE

EASEMENTS

- 1) 10' SANITARY SEWER EASEMENT
5626 O.R. 113
5626 O.R. 116
- 2) 10' SANITARY SEWER EASEMENT
3958 O.R. 236
- 3) 15' STORM DRAIN EASEMENT
3293 O.R. 649
- 4) 15' PUBLIC UTILITY AND WATER LINE EASEMENT
2450 O.R. 48

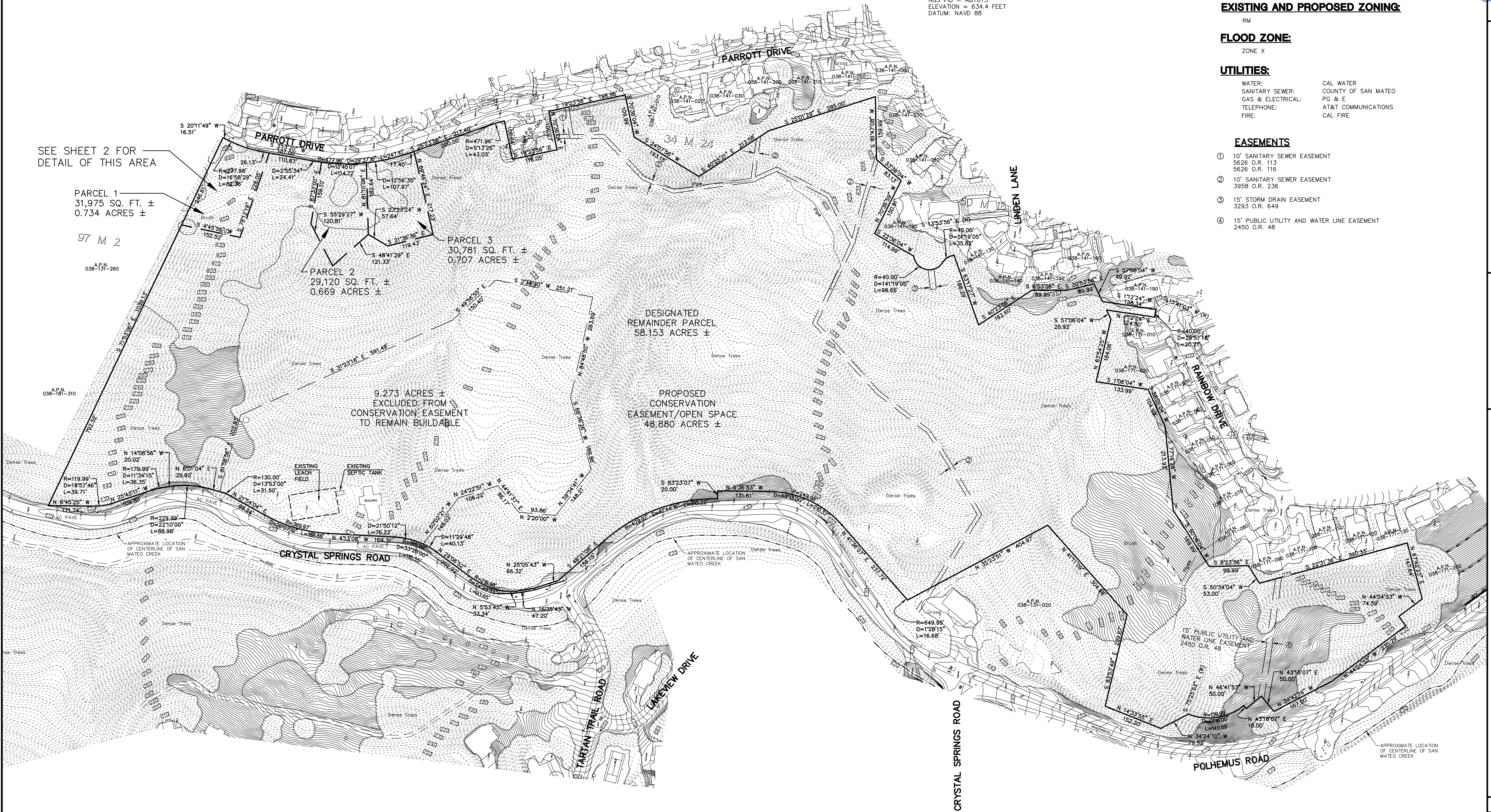

SEE SHEET 2 FOR
DETAIL OF THIS AREA

PARCEL 1
31,975 SQ. FT. ±
0.734 ACRES ±

97 M 2

A.P.N. 260

PARCEL 2
29,120 SQ. FT. ±
0.669 ACRES ±

PARCEL 3
30,781 SQ. FT. ±
0.707 ACRES ±

DESIGNATED
REMAINDER PARCEL
58.153 ACRES ±

PROPOSED
CONSERVATION
EASEMENT/OPEN SPACE
48,880 ACRES ±

9.273 ACRES ±
EXCLUDED FROM
CONSERVATION EASEMENT
TO REMAIN BUILDABLE

DATE: 11/02/08	BY: [Signature]
ADD SEPTIC SYSTEM	DESCRIPTION
DELETE ONE LOT	REV
REVISE LOT LINES	REV
REVISE LOT LINES	REV

MACLEOD AND ASSOCIATES
CIVIL ENGINEERING • LAND SURVEYING
965 CENTER STREET • SAN CARLOS • CA 94070 • (650) 593-8580

PREPARED FOR: STEVE & NICK ZMAY
 UNINCORPORATED
 CALIFORNIA
 VESTING TENTATIVE PARCEL MAP
 LANDS OF ZMAY
 BEING A PORTION OF PARCEL "A", 53 PM 56
 1551 CRYSTAL SPRINGS ROAD
 SAN MATEO COUNTY

DRAWN BY: DJK
DESIGNED BY: ---
CHECKED BY: DGM
SCALE: 1"=100'
DATE: 02-17-15
DRAWING NO. 3949-TM
SHEET 1 OF 2



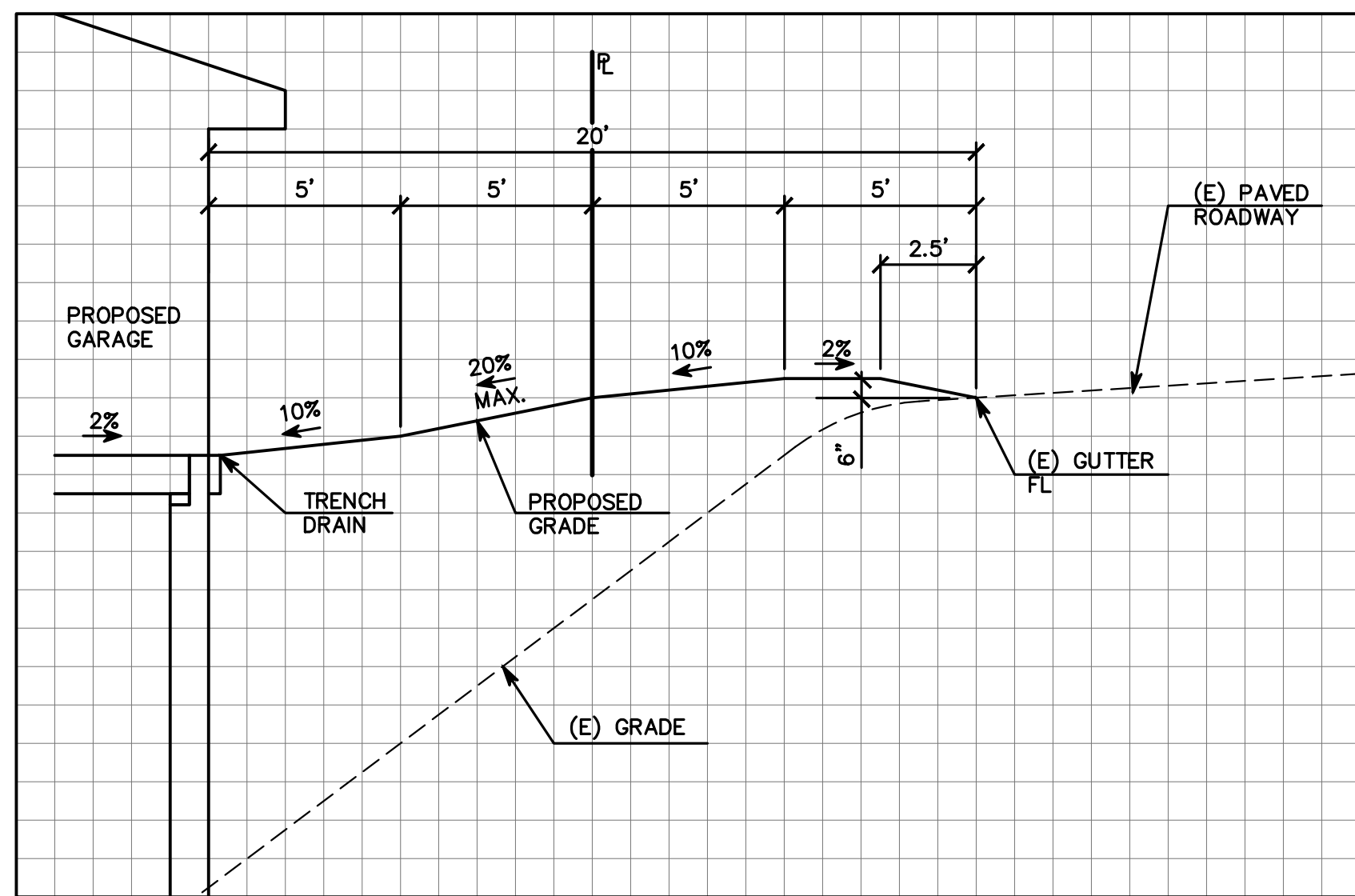

A **TYPICAL DRIVEWAY PROFILE**
SCALE: 1"=4'

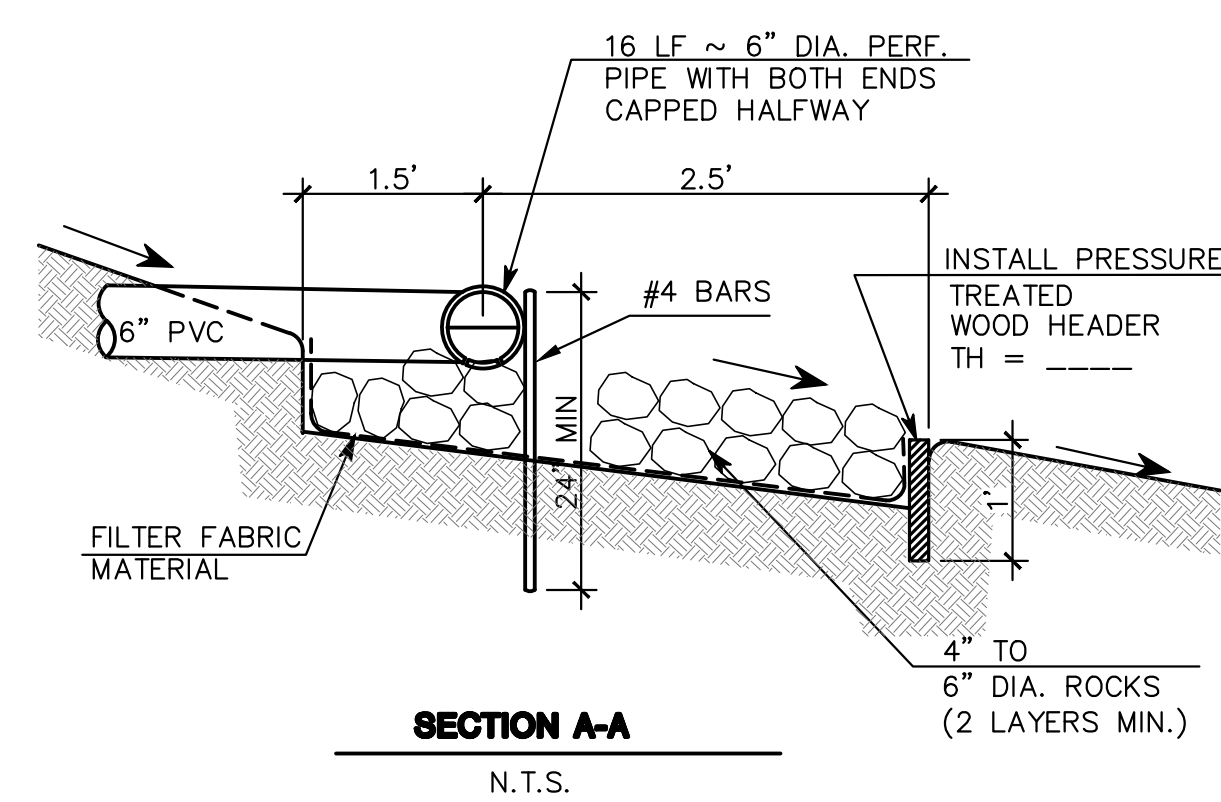

B **ENERGY DISSIPATER**
SCALE: NOT TO SCALE

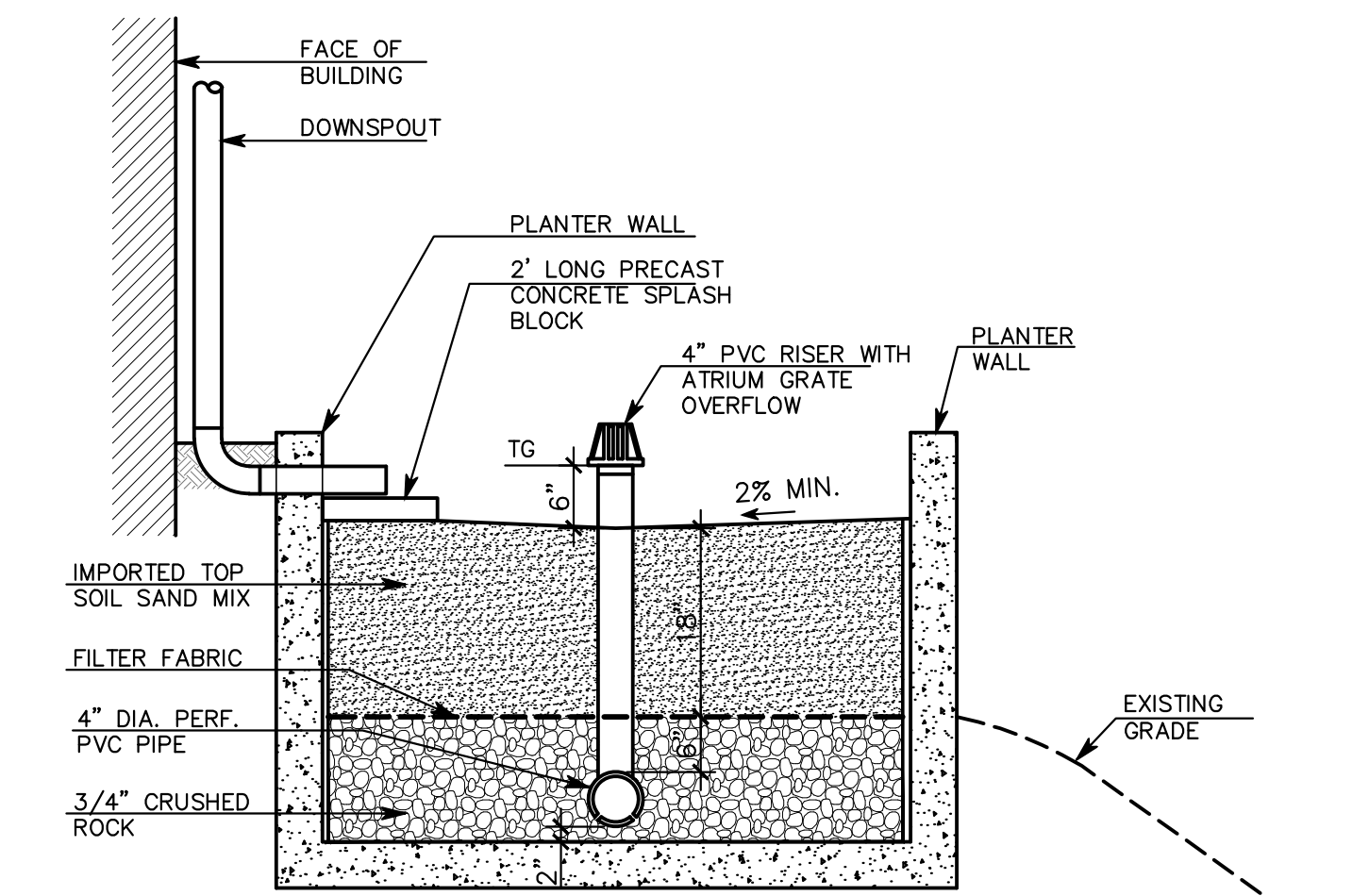
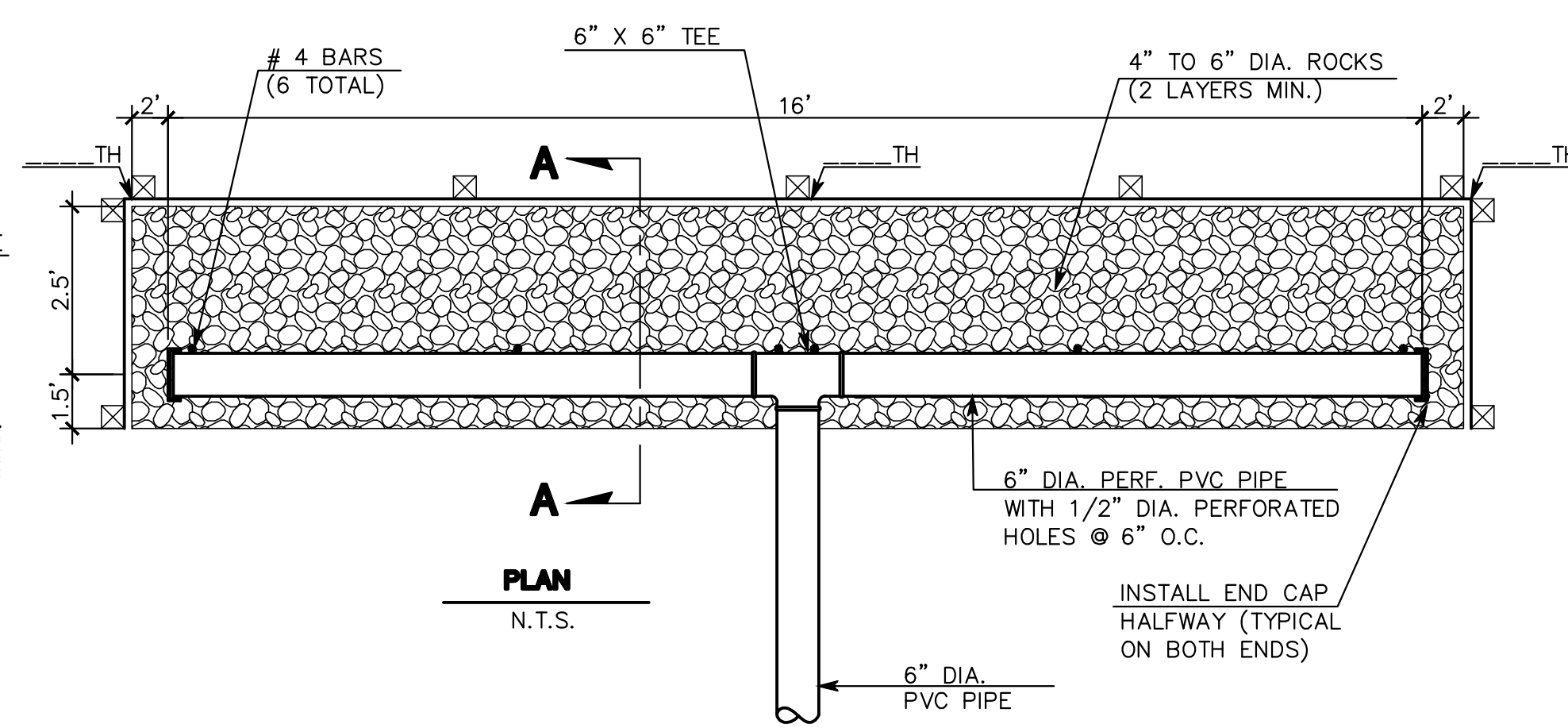

C **C-3 STORM WATER TREATMENT MEASURES (FLOW-THROUGH PLANTER BOX FILTRATION DETAIL TO SERVICE 4% OF IMPERVIOUS AREAS)**
SCALE: NOT TO SCALE

SLIDE REPAIR REVEGETATION NOTE:

AFTER COMPLETION OF GRADING, ALL DISTURBED AREAS SHALL BE HYDRO-SEEDING WITH A COSTAL MIX AT A MINIMUM RATE OF 50 POUNDS PER ACRE.

GRADING QUANTITIES:

LOTS 1 THROUGH 3:
TOTAL CUT = 510 C.Y.
TOTAL FILL = 300 C.Y.

LANDSLIDE REPAIR:
CUT = 290 C.Y. ±
FILL = 165 C.Y. ±

TOTAL AREA OF DISTURBANCE:

LOTS 1 THROUGH 3 AND LANDSLIDE REPAIR
= 67,000 S.F.
= 1.54 ACRES

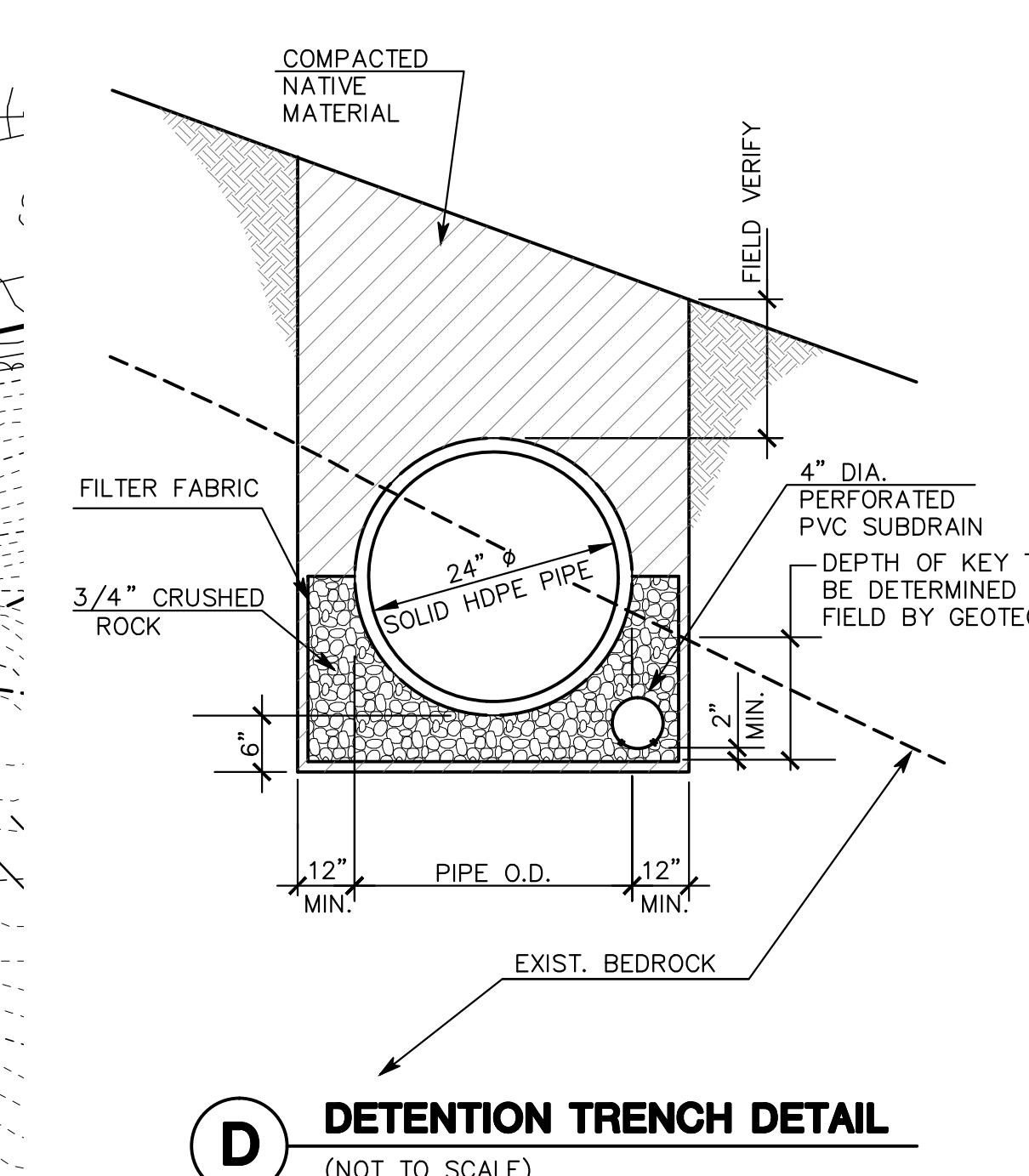
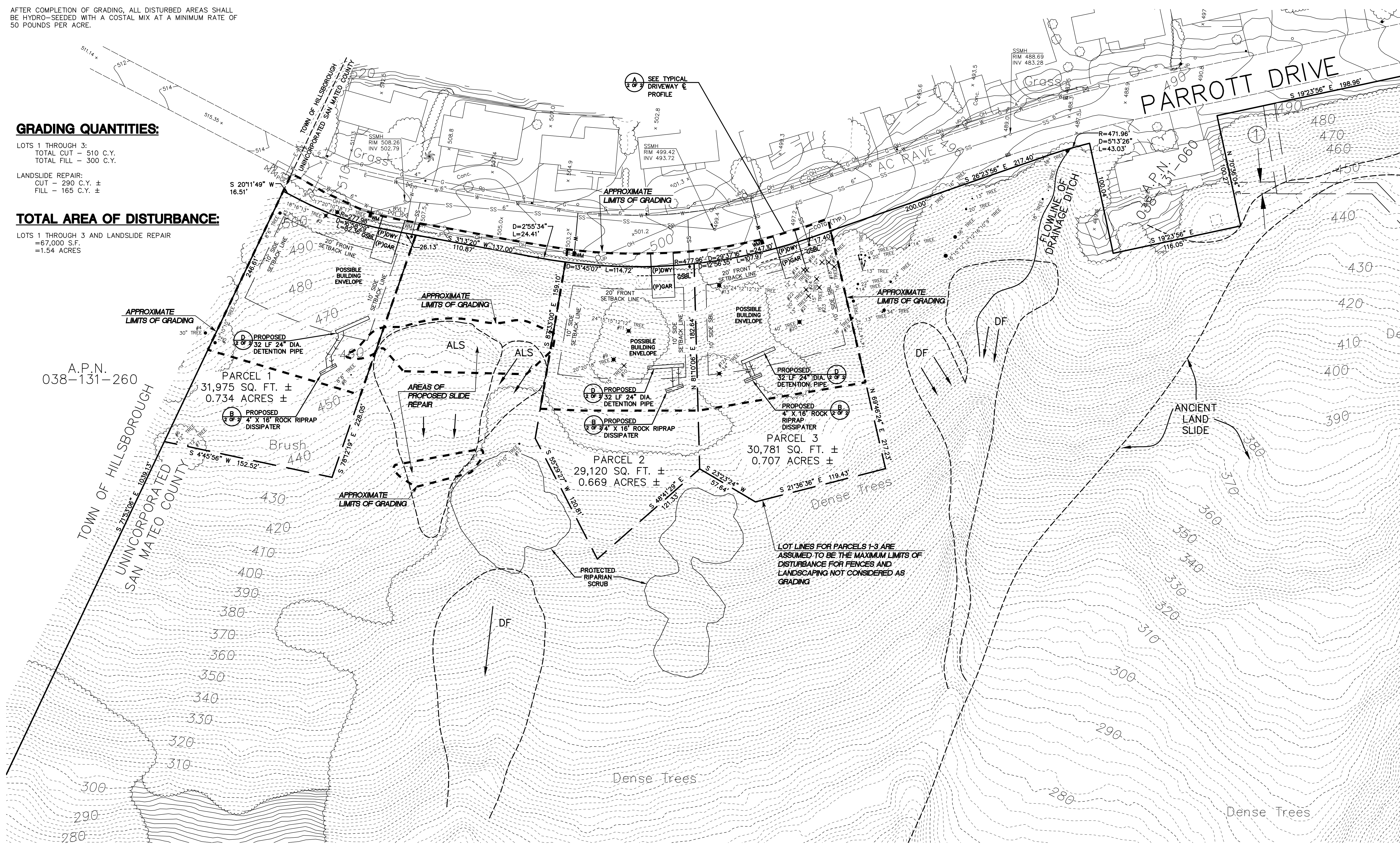

D **DETENTION TRENCH DETAIL**
(NOT TO SCALE)

LEGEND

---	PROPERTY LINE
---	PROPOSED PROPERTY LINE
ALS	ACTIVE LAND SLIDE PER GEOTECHNICAL REPORT
€	CENTER LINE
COTG	CLEANOUT TO GRADE
DF	DEBRIS FLOW PER GEOTECHNICAL REPORT
DWY	DRIVEWAY
GAR	GARAGE
SBL	GARAGE SET BACK LINE - 20' FROM CURB LINE
FL	FLOWLINE
INV.	INVERT
JP	JOINT UTILITY POLE
PGEV	PG&E VAULT
PL	PROPERTY LINE
SBL	SETBACK LINE
SSM	SANITARY SEWER MANHOLE
WM	WATER METER
WVLT	WATER VAULT
(P)	PROPOSED
M	WATER VALVE
E	ELECTRIC LINE
G	GAS LINE
OH	OVERHEAD LINE
SS	SANITARY SEWER LINE
W	WATER LINE
SS	PROPOSED SANITARY SEWER LINE
W	PROPOSED WATER LINE
COTG	PROPOSED CLEANOUT TO GRADE
WM	PROPOSED WATER METER
●	TREE W/ SIZE
■	EXISTING TREE THAT MIGHT BE REMOVED DEPENDING ON FINAL BUILDING LOCATIONS

MACLEOD AND ASSOCIATES
CIVIL ENGINEERING • LAND SURVEYING
965 CENTER STREET • SAN CARLOS • CA 94070 • (650) 593-8580

UNINCORPORATED
VESTING TENTATIVE PARCEL MAP
LANDS OF ZMAY
BEING A PORTION OF PARCEL "A", 53 PM 88
1551 CRYSTAL SPRINGS ROAD
SAN MATEO COUNTY

UNINCORPORATED

PREPARED FOR:
STEVE & NICK ZMAY

REVISIONS:

NO.	DATE	DESCRIPTION
1	11/02/18	ISSUE FOR PERMITTING
2	05/29/19	ISSUE FOR PERMITTING

DRAWN BY: DJK
DESIGNED BY: ---
CHECKED BY: DGM
SCALE: 1"=40'
DATE: 02-17-15
DRAWING NO.: 3949-TM
SHEET: 2 OF 2

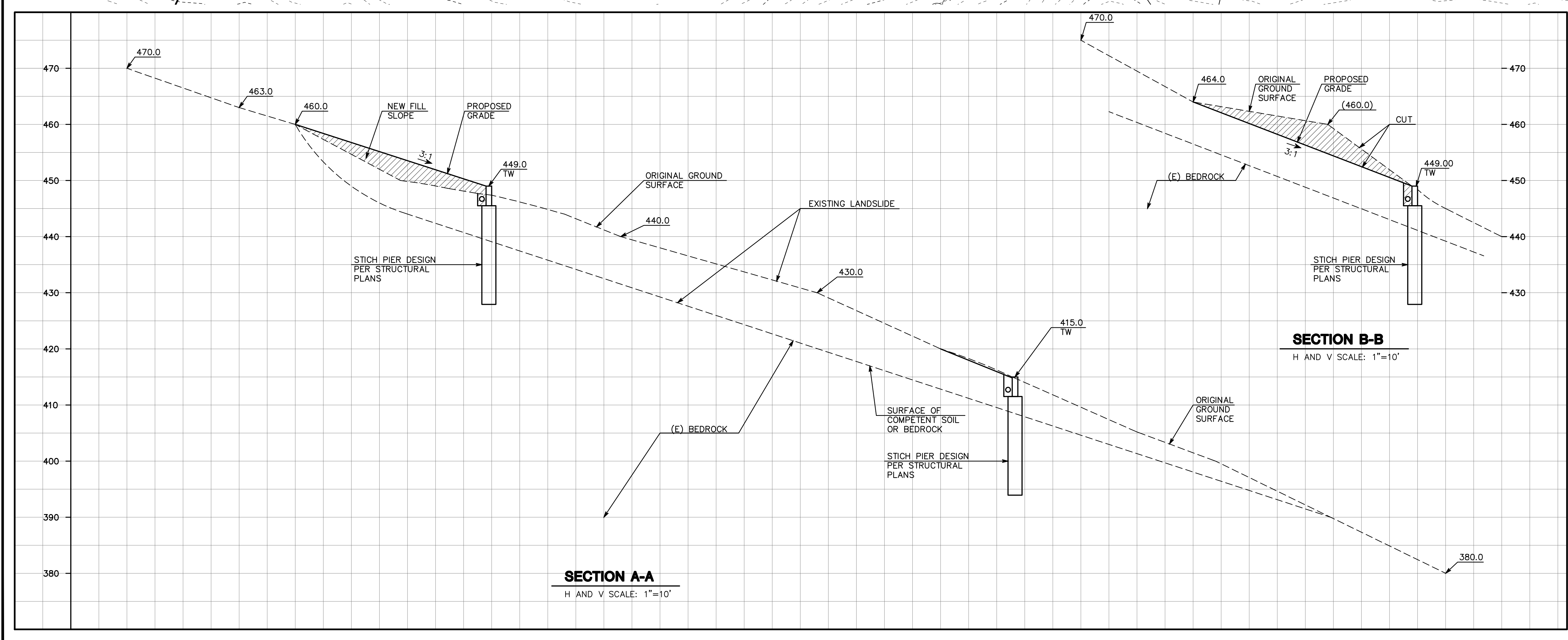
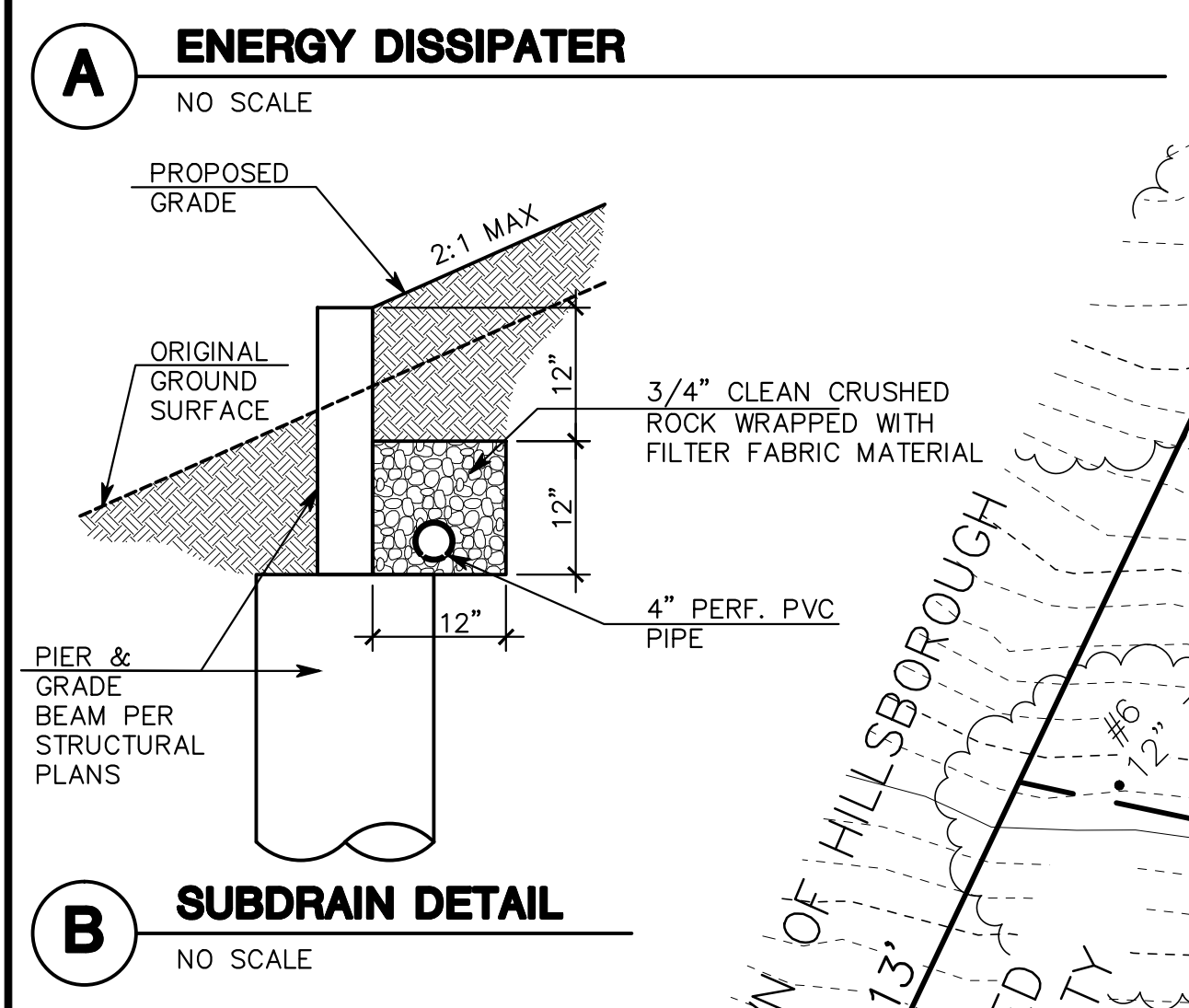
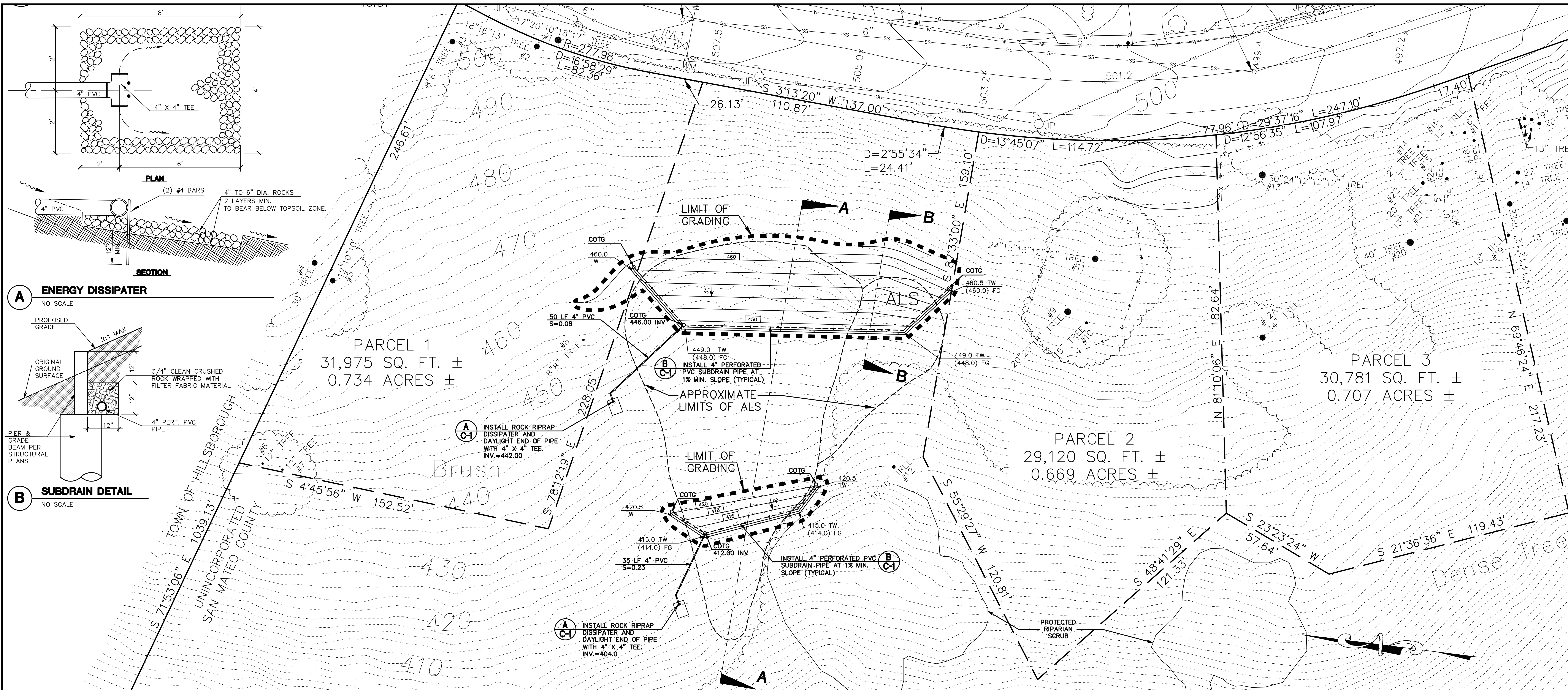

GRADING QUANTITIES:
 CUT: 290 C.Y.± (CUT & EXPORT 18" TOP SOIL)
 FILL: 165 C.Y.± (IMPORTED MATERIAL FOR ENGINEERED FILL)

LEGEND:

---	PROPERTY LINE
---	PROPOSED PROPERTY LINE
ALS	ACTIVE LANDSLIDE PER GEOTECHNICAL REPORT
⊕	CENTER LINE
---	CLEANOUT TO GRADE
INV.	INVERT
⊕	JOINT UTILITY POLE
---	PROPERTY LINE
SSMH	SANITARY SEWER MANHOLE
WM	WATER METER
WVLT	WATER VAULT
⊕	WATER VALVE
⊕	TREE W/ SIZE
---	ELECTRIC LINE
---	GAS LINE
OH	OVERHEAD LINE
SS	SANITARY SEWER LINE
---	WATER LINE
SS	PROPOSED SANITARY SEWER LINE
---	PROPOSED WATER LINE
---	NEW CONTOUR

GEOTECHNICAL ENGINEER'S NOTE

ALL EARTHWORK AND SITE DRAINAGE, INCLUDING SITE GRADING, PIER AND TIEBACK EXCAVATIONS, TIEBACK TESTING, PLACEMENT AND COMPACTION OF ENGINEERED FILL, PREPARATION OF SUBGRADE AND UNDERLAYMENT BENEATH ANY SLABS AND/OR THE DRIVEWAY, RETAINING WALL, BACKFILL, AND FINAL SURFACE DRAINAGE INSTALLATION SHOULD BE PERFORMED IN ACCORDANCE WITH THE GEOTECHNICAL REPORT PREPARED BY MURRAY ENGINEERS, INC., DATED FEBRUARY 10, 2014. MURRAY ENGINEERS, INC. SHOULD BE PROVIDED AT LEAST 48 HOURS ADVANCE NOTIFICATION OF ANY EARTHWORK OPERATIONS AND SHOULD BE PRESENT TO OBSERVE AND TEST, AS NECESSARY, THE EARTHWORK, FOUNDATION, AND DRAINAGE INSTALLATION PHASES OF THE PROJECT.

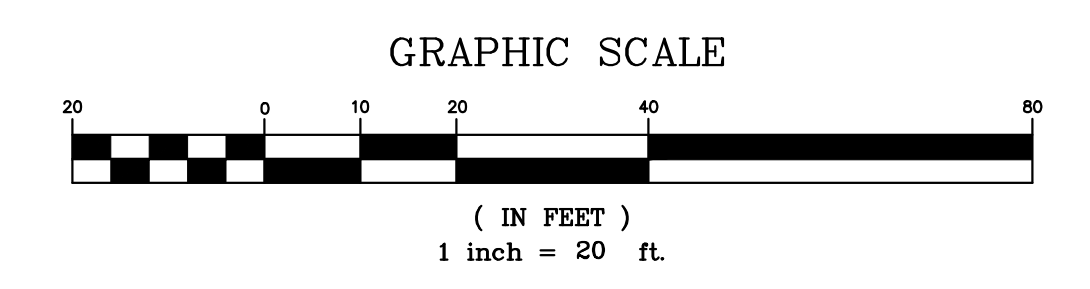

MACLEOD AND ASSOCIATES
 CIVIL ENGINEERING • LAND SURVEYING
 965 CENTER STREET • SAN CARLOS • CA 94070 • (650) 593-8580

UNINCORPORATED

1551 CRYSTAL SPRINGS ROAD
 SAN MATEO COUNTY

UNINCORPORATED

PREPARED FOR:
 STEVE & NICK ZMAY

DATE: 03-20-15
 DRAWING NO. 3949-14
 SHEET 1 OF 2

REVISIONS:
 VFG 09/19/18
 DGM 11/02/18
 VFG 05/16/15

DESCRIPTION: GRADING & DRAINAGE PLAN FOR SLIDE REPAIR

C-1

LEGEND	
---	PROPERTY LINE
---	PROPOSED PROPERTY LINE
ALS	ACTIVE LAND SLIDE PER GEOTECHNICAL REPORT
⊙	CENTER LINE
COTG	CLEANOUT TO GRADE
INV.	INVERT
JP	JOINT UTILITY POLE
P	PROPERTY LINE
SSMH	SANITARY SEWER MANHOLE
WM	WATER METER
WM	WATER VAULT
WV	WATER VALVE
⊙	TREE W/ SIZE
E	ELECTRIC LINE
G	GAS LINE
OH	OVERHEAD LINE
SS	SANITARY SEWER LINE
W	WATER LINE
SS	PROPOSED SANITARY SEWER LINE
W	PROPOSED WATER LINE
---	NEW CONTOUR

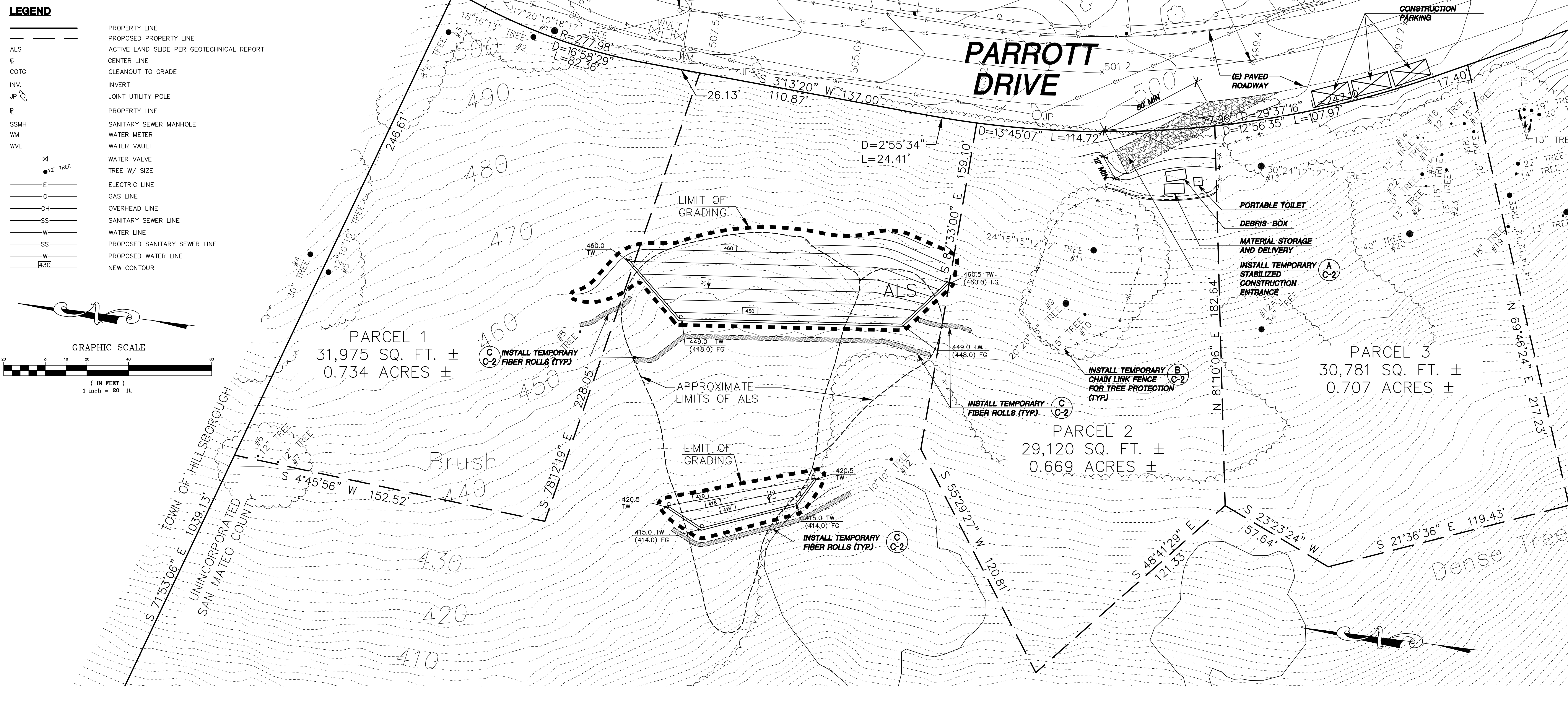
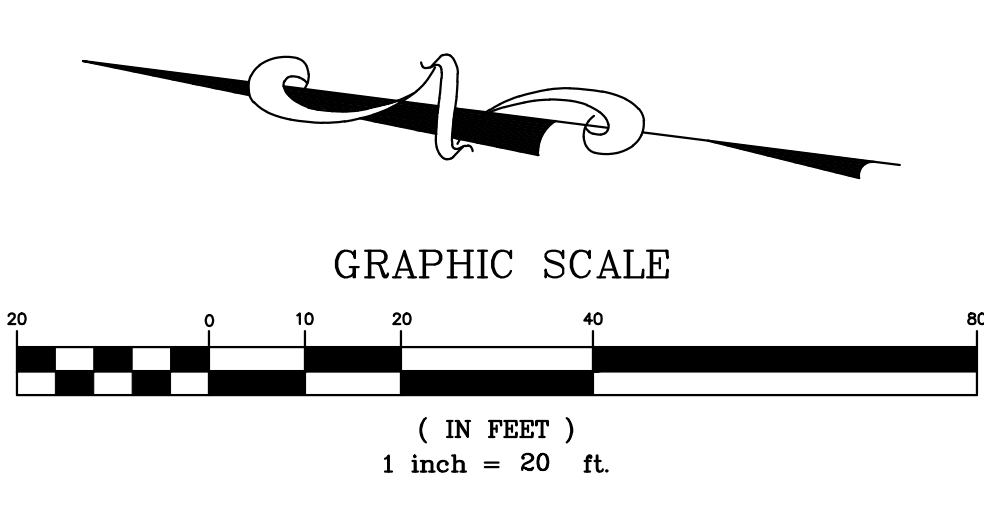

REVEGETATION NOTE:

AFTER COMPLETION OF GRADING, ALL DISTURBED AREAS SHALL BE HYDRO-SEEDED WITH A COSTAL MIX AT A MINIMUM RATE OF 50 POUNDS PER ACRE.

CONSTRUCTION SCHEDULE:

START OF PROJECT : APRIL 2015
ESTIMATED PROJECT : JULY 2015
COMPLETION

EROSION CONTROL NOTES:

- THE INTENT OF THE EROSION CONTROL PLAN IS TO MINIMIZE ANY WATER QUALITY IMPACTS IN THE FORM OF SEDIMENT POLLUTION TO MAIN CREEK & TRIBUTARIES.
- A CONSTRUCTION ENTRANCE WILL BE INSTALLED PRIOR TO OF GRADING. LOCATION OF THE ENTRANCE MAY BE ADJUSTED BY THE CONTRACTOR TO FACILITATE GRADING OPERATIONS. ALL CONSTRUCTION TRAFFIC ENTERING THE PAVED ROAD MUST CROSS THE CONSTRUCTION ENTRANCE. THE ENTRANCE SHALL BE MAINTAINED IN A CONDITION THAT WILL PREVENT TRACKING OR FLOWING OF SEDIMENT ONTO PUBLIC RIGHTS-OF-WAY. THIS MAY REQUIRE PERIODIC TOP DRESSING WITH ADDITIONAL STONE AS CONDITION DEMAND, AND REPAIR OF ANY MEASURES USED TO SEDIMENTS.
- WHEN NECESSARY, WHEELS SHALL BE CLEANED TO REMOVE SEDIMENT PRIOR TO ENTRANCE ONTO PUBLIC RIGHT-OF WAY. WHEN WASHING IS REQUIRED, IT SHALL BE DONE ON AN AREA STABILIZED WITH CRUSHED STONE WHICH DRAINS INTO AN APPROVED SEDIMENT BASIN. ALL SEDIMENT SHALL BE PREVENTED FROM ENTERING ANY STORM DRAIN, DITCH, OR WATERCOURSE THROUGH THE USE OF SAND BAGS, GRAVEL, BOARDS OR OTHER APPROVED METHODS.
- THE EROSION AND SEDIMENT CONTROL MEASURES WILL BE OPERABLE ALL YEAR LONG. UNTIL GRADING AND INSTALLATION OF STORM DRAINAGE AND PERMANENT EROSION AND SEDIMENT CONTROL FACILITIES WILL BE COMPLETED. NO GRADING WILL OCCUR BETWEEN OCTOBER 1 AND APRIL 30 UNLESS AUTHORIZED BY THE CITY REPRESENTATIVE.
- DURING THE RAINY SEASON, ALL PAVED AREAS WILL BE KEPT CLEAR OF EARTH MATERIAL AND DEBRIS. THE SITE WILL BE MAINTAINED SO THAT A MINIMUM OF SEDIMENT-LADEN RUNOFF ENTERS THE STORM DRAINAGE SYSTEM.
- ALL EROSION AND SEDIMENTATION CONTROL MEASURES SHALL BE IN ACCORDANCE WITH THE EROSION AND SEDIMENT CONTROL FIELD MANUAL OF THE CALIFORNIA REGIONAL WATER QUALITY CONTROL BOARD, 4TH EDITION, DATED AUGUST 2002.
- INSTALL TEMPORARY EROSION CONTROL OVER DISTURBED AREAS UTILIZING STRAW MULCH.
- USE SEDIMENT CONTROLS OR FILTRATION TO REMOVE SEDIMENT WHEN DEWATERING SITE AND OBTAIN REGIONAL WATER QUALITY CONTROL BOARD (RWQCB) PERMIT(S) AS NECESSARY.

SAN MATEO COUNTY STANDARD NOTES:

- EROSION CONTROL POINT OF CONTACT:
OWNER: NICK ZMAY
EMAIL: NICKZ93@SBCGLOBAL.NET
TEL: (650) 430-0075
- PERFORM CLEARING AND EARTH-MOVING ACTIVITIES ONLY DURING DRY WEATHER. MEASURES TO ENSURE ADEQUATE EROSION AND SEDIMENT CONTROL SHALL BE INSTALLED PRIOR TO EARTH-MOVING ACTIVITIES AND CONSTRUCTION.
- STABILIZE ALL DENUDED AREAS AND MAINTAIN EROSION CONTROL MEASURES CONTINUOUSLY BETWEEN OCTOBER 1 AND APRIL 30.
- STORE, HANDLE, AND DISPOSE OF CONSTRUCTION MATERIALS AND WASTES PROPERLY, SO AS TO PREVENT THEIR CONTACT WITH STORMWATER.
- CONTROL AND PREVENT THE DISCHARGE OF ALL POTENTIAL POLLUTANTS, INCLUDING PAVEMENT CUTTING WASTES, PAINTS, CONCRETE, PETROLEUM PRODUCTS, CHEMICALS, WASH WATER OR SEDIMENTS AND NON-STORMWATER DISCHARGES TO STORM DRAINS AND WATERCOURSES.
- AVOID CLEANING, FUELING, OR MAINTAINING VEHICLES ON-SITE, EXCEPT IN A DESIGNATED AREA WHERE WASH WATER IS CONTAINED AND TREATED.
- LIMIT AND TIME APPLICATIONS OF PESTICIDES AND FERTILIZERS TO PREVENT POLLUTED RUNOFF.
- LIMIT CONSTRUCTION ACCESS ROUTES TO STABILIZED, DESIGNATED ACCESS POINTS.
- AVOID TRACKING DIRT OR OTHER MATERIALS OFF-SITE; CLEAN OFF-SITE PAVED AREAS AND SIDEWALKS USING DRY SWEEPING METHODS.
- TRAIN AND PROVIDE INSTRUCTION TO ALL EMPLOYEES AND SUBCONTRACTORS REGARDING THE WATERSHED PROTECTION MAINTENANCE STANDARDS AND CONSTRUCTION BEST MANAGEMENT PRACTICES.
- THE AREAS DELINEATED ON THE PLANS FOR PARKING, GRUBBING, STORAGE ETC., SHALL NOT BE ENLARGED OR "RUN OVER".
- CONSTRUCTION SITES ARE REQUIRED TO HAVE EROSION CONTROL MATERIALS ON-SITE DURING THE "OFF-SEASON".
- DUST CONTROL IS REQUIRED YEAR-ROUND.
- EROSION CONTROL MATERIALS SHALL BE STORED ON-SITE.
- CONSTRUCTION SITES ARE REQUIRED TO HAVE EROSION CONTROL MATERIALS ON-SITE DURING THE "OFF-SEASON".
- THE TREE PROTECTION SHALL BE IN PLACE BEFORE ANY GRADING, EXCAVATING OR GRUBBING IS STARTED.

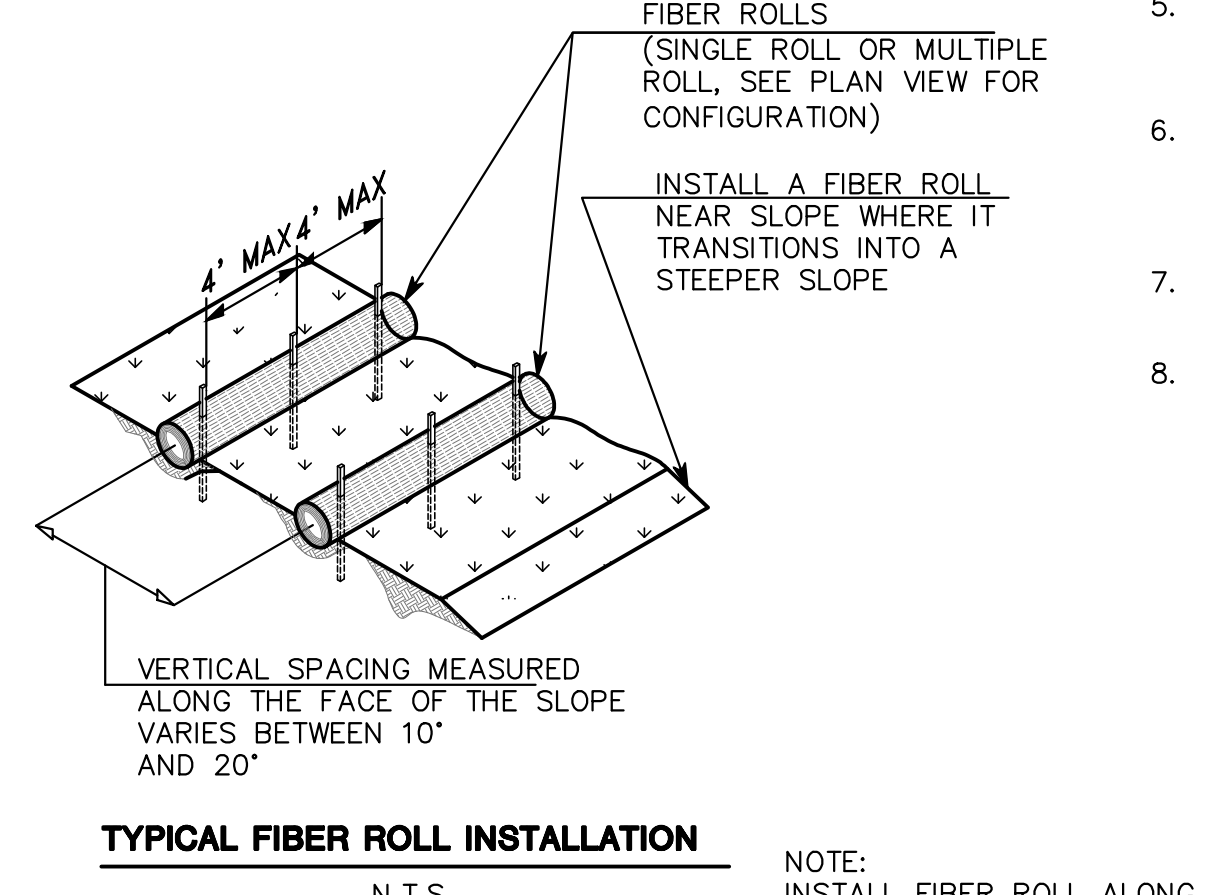
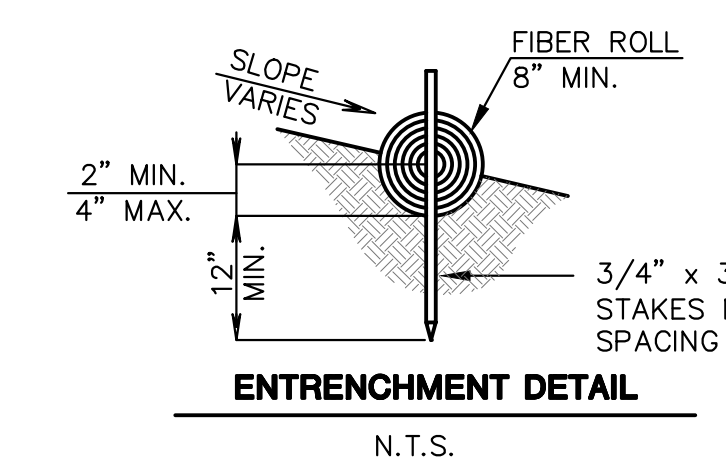
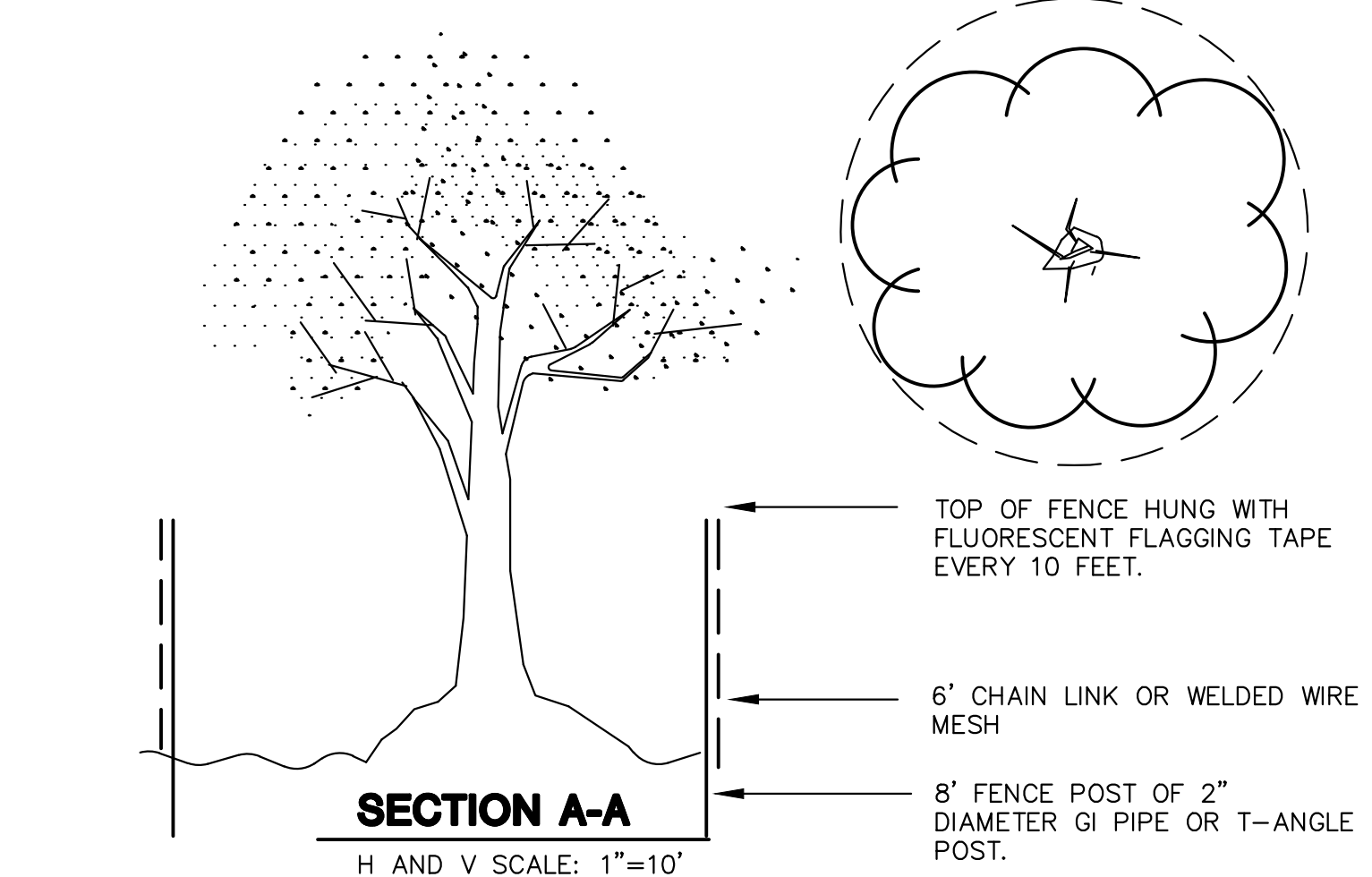
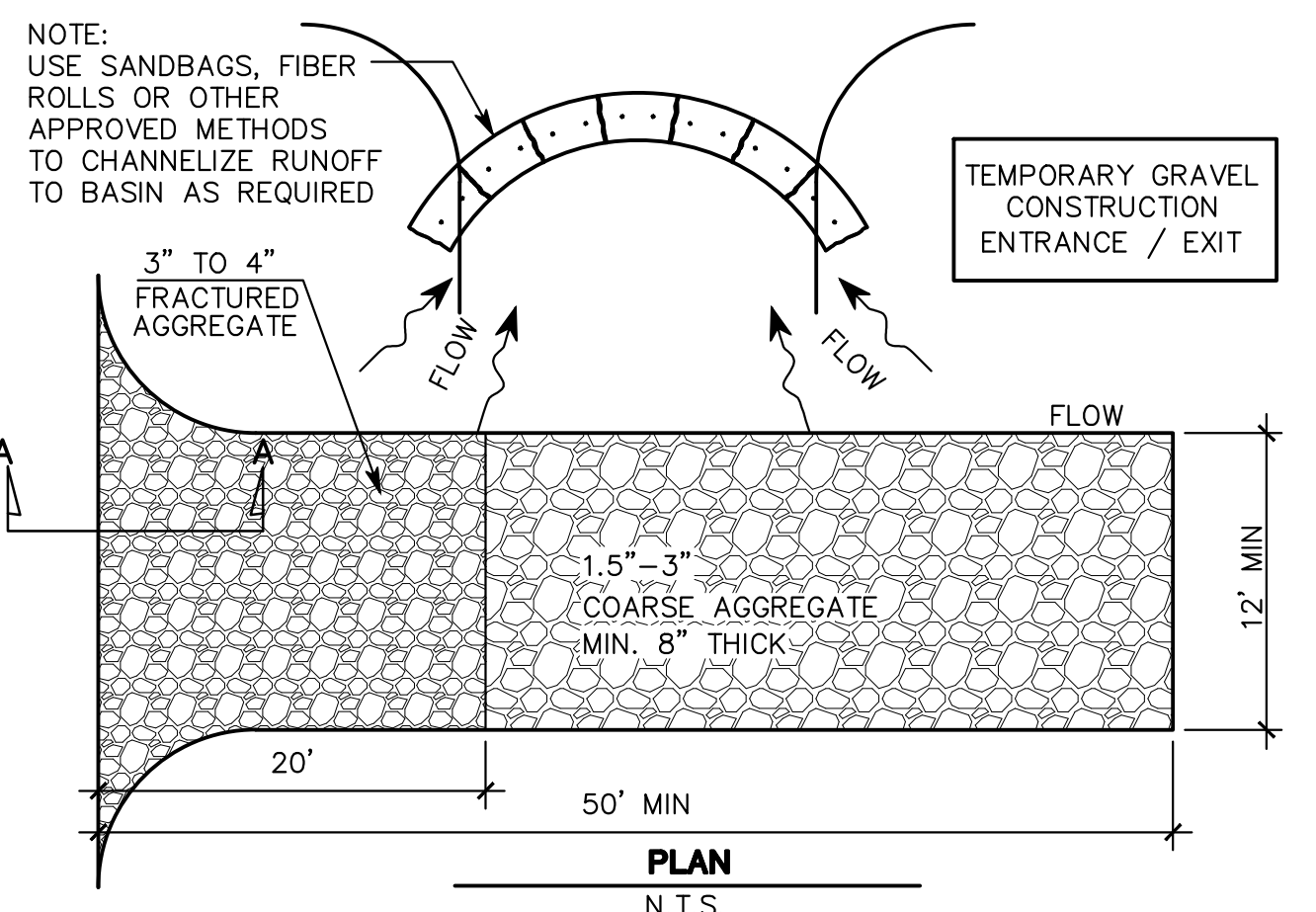
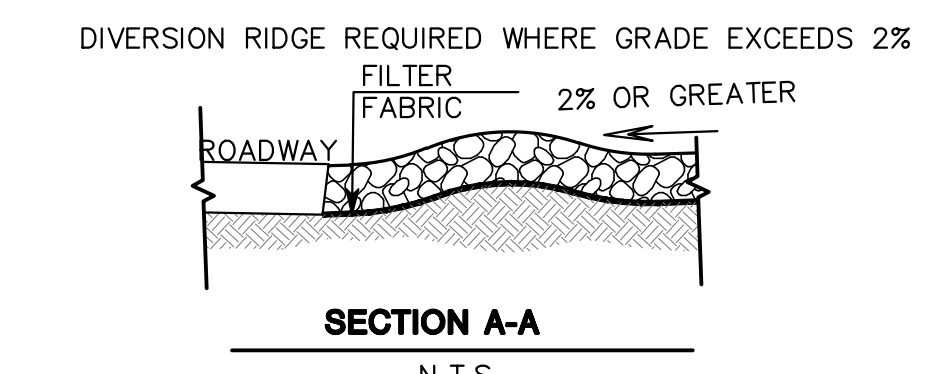

PROFESSIONAL SEAL: NICK ZMAY, CIVIL ENGINEER, No. 55048, STATE OF CALIFORNIA

MACLEOD AND ASSOCIATES
CIVIL ENGINEERING • LAND SURVEYING
965 CENTER STREET • SAN CARLOS, CA 94070 • (650) 593-8580

PREPARED FOR: STEVE & NICK ZMAY

UNINCORPORATED

1551 CRYSTAL SPRINGS ROAD, SAN MATEO COUNTY, CALIFORNIA

EROSION AND SEDIMENTATION CONTROL PLAN WITH TREE PROTECTION

DRAWN BY: AAP
DESIGNED BY: VPG
CHECKED BY: DGM
SCALE: 1"=20'
DATE: 03-20-15
DRAWING NO. 3949-14
SHEET 2 OF 2